

EX LIBRIS

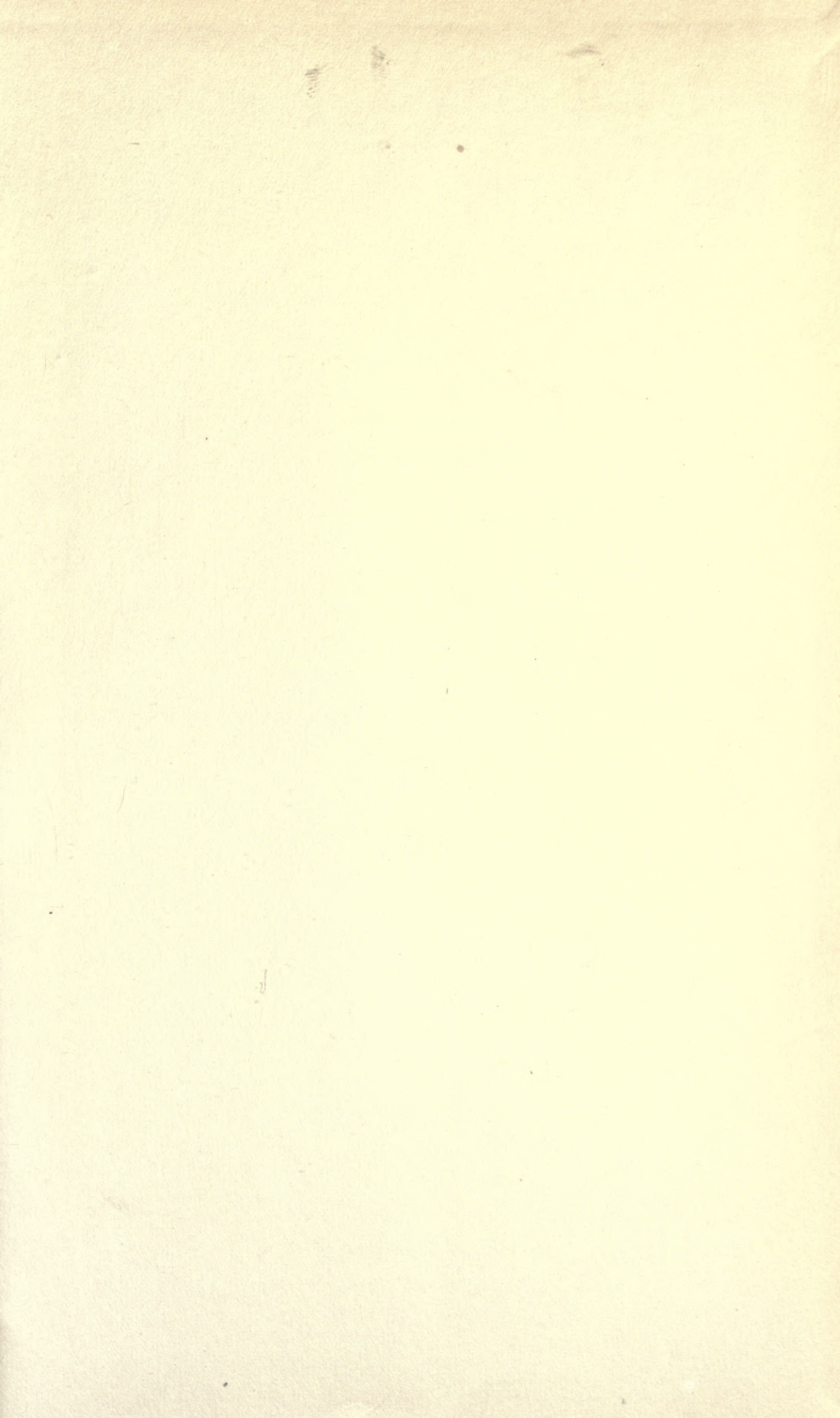

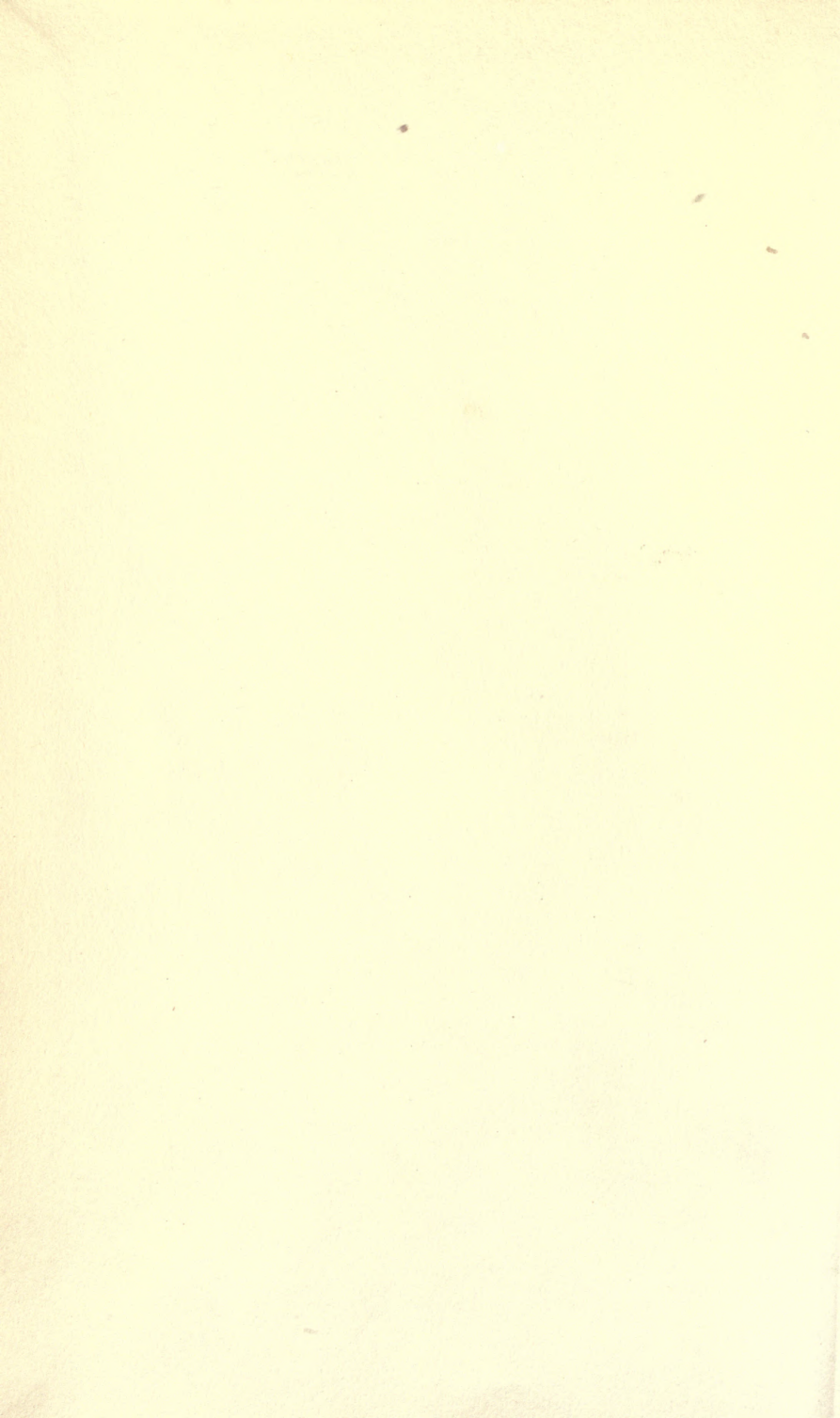

ELECTRICAL ENGINEERING
MEASURING INSTRUMENTS.

FOR COMMERCIAL AND LABORATORY
PURPOSES

BY

G. D. ASPINALL PARR

M. INST. E. E.; A. M. I. MECH. E.

Associate of the Central Technical College, City and Guilds of London
Head of the Electrical Engineering Department, Yorkshire College, Victoria University

WITH 370 ILLUSTRATIONS



LONDON

BLACKIE & SON, LIMITED, 50 OLD BAILEY, E.C.
GLASGOW AND DUBLIN

1903

20543

P3

HALLIDIE

PREFACE

While much has been written in connection with almost every section or branch of electrical engineering, including dynamos, motors, transformers, cells, and appliances of almost every description, the branch dealing with the subject of measuring instruments used in electrical engineering has received little or no attention from the literary section of the electrical community.

The fact that, without these measuring instruments, the appliances just enumerated could never have been evolved, or, being evolved, could never have been successfully utilized, constitutes, therefore, a sufficient reason for bringing the present work before the public.

Since the electrical engineering industry began to show signs of rapid development, numerous types and forms of measuring instruments have been devised by different inventors. Many of these are now obsolete, having given place to instruments with greater refinements and on better principles. Though several of these obsolete types are extremely interesting, and, indeed, instructive, they have not been described in the present work. If information regarding them is required, it will be found in the abridged patent specifications since about 1880. Only those instruments in actual and extensive use at the present day are here considered, and these form so large a body that it seems better not to try to deal with the historical portion of the subject.

I have divided the subject into chapters, each treating of different types or makes of instruments working on the same principle, and I have endeavoured to describe and illustrate each instrument as clearly and simply as possible. Comparisons, which are at the best odious, I have studiously avoided, and instead I have opened each chapter with general considerations and an

enumeration of the advantages and disadvantages pertaining to the type discussed therein. The reader has, therefore, only to consider for himself which class or make of instrument is the best for any particular purpose. The opening chapter deals with general considerations relating to and affecting all types of instruments. In addition to the instruments used at present in this country, many Continental types will be found fully described in this volume.

In conclusion, I wish to tender my sincere thanks to the many firms, whose names I have in each case mentioned when describing the instruments, for the very kind and courteous way in which they have supplied me with information, and in many cases with the blocks of illustrations of their instruments. I regret that, owing to limitations in space, and the large number of names, I am unable to enumerate them here.

G. D. A. P.

YORKSHIRE COLLEGE. LEEDS, 1903.

CONTENTS

CHAPTER I

GENERAL CONSIDERATIONS

The electric current — its direction and properties. Classification of electrical engineering measuring instruments. Controlling forces. Magnetic shielding. Solenoids. Sources of error. Method of minimizing heating errors. Compensating devices pp. 1-17

CHAPTER II

MOVING-NEEDLE ELECTRO-MAGNETIC INSTRUMENTS

Sources of error. The moving-coil dynamometer type. The moving-coil permanent-magnet type. The induction type. The Atkinson ammeters and voltmeters. Pocket ammeters and voltmeters. Kelvin ampere and volt gauges. Kramer's electro-magnetic ammeters and voltmeters. The "E.E.C." universal ammeters and voltmeters. The Harrison ammeters and voltmeters. Siemens Bros. & Co.'s ammeters and voltmeters. The Evershed ammeters and voltmeters. The "N.C.S." ammeters and voltmeters. The Holden, Drake, and Gorham ammeters and voltmeters. The Dolivo ammeters and voltmeters. The Stanley ammeters and voltmeters. Miller's electro-magnetic ammeters and voltmeters. Hartmann & Braun's ammeters and voltmeters (electro-magnetic type). The Schuckert ammeters and voltmeters. The "Castle" ammeters and voltmeters. The "Victory" ammeters and voltmeters pp. 18-59

CHAPTER III

MOVING-COIL ELECTRO-MAGNETIC INSTRUMENTS

Ayrton & Mather's astatic voltmeter. Siemens' electro-dynamometer. Siemens' torsional moving-magnet voltmeter. Fleming & Gimmingham's voltmeter. Parr's direct-reading dynamometer ammeter and voltmeter. Electrical Co.'s moving-coil alternating-current voltmeter, and moving-coil alternating-current ammeter. The Weston standard portable moving-coil voltmeter. Illuminated-dial instruments. Davies moving-coil voltmeter. Electrical Co.'s moving-coil ammeters and voltmeters (for direct currents). Siemens Bros. & Co.'s moving-coil ammeters and voltmeters. The Evershed moving-coil ammeters and voltmeters. The "N.C.S." moving-coil ammeters and voltmeters. The Stanley moving-coil ammeters and voltmeters. The Weston ammeters and voltmeters. Hartmann & Braun's moving-coil ammeters and voltmeters. The "Victory" moving-coil ammeters and voltmeters. The Electrical Co.'s alternating-current induction ammeters and voltmeters. Ferraris induction ammeters, voltmeters, and wattmeters. Westinghouse induction ammeters and voltmeters . . pp. 60-122

CHAPTER IV

HOT-WIRE AND ELECTRO-STATIC INSTRUMENTS

General considerations. Cardew hot-wire voltmeter. Cardew low-reading hot-wire voltmeter. Hartmann & Braun's hot-wire voltmeter. Hartmann & Braun's hot-wire ammeter. Ayrton & Mather's electro-static voltmeter

(gravity-station type). Ayrton & Mather's electro-static voltmeter (for low pressures). Kelvin's multicellular electro-static voltmeter (laboratory type). Kelvin's multicellular voltmeter multiplier. Kelvin's multicellular electro-static voltmeter (vertical-scale engine-room type). Kelvin's multicellular electro-static voltmeter (high-tension dial form). Voysey & Wilson's electro-static ampere meter (for alternating currents only) pp. 123-152

CHAPTER V

ELECTRO-MAGNETIC WATTMETERS

General considerations. Siemens' dynamometer wattmeter. The Weston standard portable non-inductive wattmeter. Kelvin engine-room wattmeter. Kelvin three-phase wattmeter. Everett, Edgcombe, & Co.'s wattmeters. Siemens' "Precision" wattmeter. The Electrical Co.'s induction wattmeter. Parr's direct-reading dynamometer wattmeter. The Electrical Co.'s moving-coil alternating-current wattmeter pp. 153-171

CHAPTER VI

RECORDING AMMETERS, VOLTMETERS, AND WATTMETERS

General considerations. Holden recording ammeters and voltmeters. Kelvin's recording ammeters and voltmeters. Everett, Edgcombe, & Co.'s recording ammeters and voltmeters. Harrison's recording voltmeter. Harrison's recording ammeter. The Electrical Co.'s recording induction wattmeter . . . pp. 172-182

CHAPTER VII

MISCELLANEOUS STANDARD AND OTHER INSTRUMENTS

Lord Kelvin's standard electrical balances. Kelvin's standard centi-ampere balance. Kelvin's standard composite balance. Potentiometer standard measuring instruments. Crompton potentiometer. The Electrical Co.'s alternating-current induction phasemeter. Campbell's frequency-teller. The Stanley earth-resistance indicator pp. 183-200

CHAPTER VIII

ELECTRICITY SUPPLY METERS

General considerations. Classification of instruments. The Bastian electricity meter. Edison's electrolytic electricity meter. The Long-Schattner prepayment electricity meter. The Schattner standard meter. Wright's electrolytic meter. The Wright demand indicator. The Siemens' electricity supply meter (for continuous currents). Kelvin's electricity supply meter. The Electrical Co.'s electricity meter (for direct currents only). The Ferranti electricity meter. The Hookham direct-current electricity meter. Ferraris electricity supply meter (for single and polyphase alternating currents). Elihu Thomson's electricity meter. The Vulcan electricity meter. The Vulcan prepayment electricity meter. Schallenberger electricity meter. The Westinghouse electricity meter. The Electrical Co.'s alternating-current electricity meter. The Electrical Co.'s alternating-current electricity meter—"small type". High-tension alternating-current meters. The Hookham alternating-current electricity meter—square pattern and round pattern. The Aron electricity meter. The Aron day and night load electricity meter. The Electrical Co.'s direct-current time-check meter. The Aron electric time-check meter pp. 201-322

APPENDIX p. 323

INDEX p. 324

ELECTRICAL MEASURING INSTRUMENTS



CHAPTER I

GENERAL CONSIDERATIONS

Perhaps there is no subject connected with electrical matters at the present day which is of more supreme importance than that of electrical measuring instruments. In fact, it may truthfully be said that the whole electrical engineering industry, which is just now developing into such enormous proportions, owes its very existence to the simultaneous improvement of the electrical measuring instrument, without which it would be utterly impossible to successfully apply the many principles that are now used in electrical devices, or appliances.

It is practically only since about 1880, that this particular section, or branch, of the industry has developed. Prior to that date, there were a few very crude forms of measuring—perhaps they ought to be more properly termed *indicating*—instruments, and these were only used for the small currents then obtainable from primary cells.

Since the above date, the introduction of dynamos, electromotors, and other appliances for producing and using heavier currents, has made the production of electrical instruments suitable for the *accurate* measurement of electric currents, pressures, power, and energy, absolutely indispensable.

There are many conventionalities met with in electrical engineering; for instance, it is customary to speak of the *flow* of electricity, a term which seemingly implies matter in motion.

In reality, however, we are able to see nothing of this flow; nor do we know that there is anything actually at all in motion;

and further, we have not the slightest knowledge of the direction of such flow.

All we know is, that certain *effects* manifest themselves to us when a current of electricity is said to flow in a given circuit, which were not apparent before or after the supposed flow took place.

Thus, in the measurement of *current, pressure, power, and energy*, each of which depends on the measurement of one or more currents separately, or together, we are obliged to make use of, and to measure, the *effects* of such currents. The properties or effects of an electric current, in virtue of which we are able to obtain a measure of it, are as follows:—

(1) The *electro-magnetic effect*, in virtue of which a magnetic field is created by the current, and lines of magnetic force are produced.

(2) The *electro-static effect*, in virtue of which electrical energy is stored in an arrangement of two metallic conductors connected to the circuit, these conductors being separated by an insulator.

(3) The *heating effect*, in virtue of which heat is produced whenever a current, however small, flows.

(4) The *chemical effect*, in virtue of which liquids are decomposed when a current passes through them.

Each of these effects is made use of at the present day in constructing electrical instruments to measure a current.

The field of measurement, however, is increased by the fact that two different kinds of currents have to be dealt with, namely, continuous, that is, direct or unidirectional currents, and alternating or periodic currents.

The first three effects are produced by both kinds of currents, the last effect is caused by continuous but not by alternating currents.

Much more difficulty is experienced in accurately measuring an alternating than a continuous current; and, with some few exceptions, the same instrument will not measure both currents equally accurately. In other cases, an instrument for measuring an alternating current will not read accurately, when used on a circuit in which the rate of reversal, or periodicity, of the alternating current is different.

Since, in most cases, however, the advantages and disadvantages, peculiarities, and errors to be looked for in any particular instru-

ment are common to all instruments belonging to that class or type, they will be stated generally when each class is considered.

Electrical engineering measuring instruments may be divided into classes according to the principle on which they work, *i.e.* according to which of the effects above mentioned, due to a current, is made use of in the measurement required.

This classification is consequently fourfold—all instruments working on one or other of the four principles or effects mentioned on p. 2, namely: (1) electro-magnetic, (2) electro-static, (3) thermal, (4) chemical.

In the following pages we shall confine ourselves to the four branches of measurement commonly met with in practice, namely, the measurement of *current*, *pressure*, *power*, and *energy*.

Instruments for measuring so-called currents of electricity are termed *ammeters* or *ampere-meters*; and a great number of such instruments have been devised in recent years. Some of these are accurate and well-designed instruments, which have survived the test of time and usage. Others have become obsolete owing to defects in their design. These latter will not be considered in this work, though much useful information, and much valuable experience, can be gleaned from the study of some of these instruments.

The reader, however, will find practically all of them described in the patent-office specifications on this subject.

The existing types of current-measuring instruments may be subdivided as follows:—

Ammeters.	{ Electro-magnetic.	{ Moving Needle.
		{ „ Coil, Dynamometer.
		{ „ „ Permanent-Magnet (direct currents only).
	{ Hot-Wire.	{ Induction (alternating currents only).

With the exception of the two types specified, each of the above can be used to measure both continuous and alternating currents.

It should be noted, however, that only the *moving-coil dynamometer* and *hot-wire* types, read equally accurately on either direct or alternating current circuits, with the same scale, the other types having to be calibrated to suit the nature of the circuit in which they are used.

Instruments for measuring pressures—or, as they are sometimes termed, tensions—of electricity are called *voltmeters*; and these may be divided into precisely the same forms as the ammeters above, but to these forms the electro-static type of voltmeter must be added. This, in common with the dynamometer and hot-wire types, will measure with the same scale either direct or alternating pressures equally accurately.

The other remarks relating to ammeters apply equally well to voltmeters, the only difference between am- and volt-meters, with one or two exceptions, being in the gauge, and in the number of turns with which the coils are wound.

Instruments for measuring electrical power are termed *wattmeters*; and those in use at the present day work by the electromagnetic effect of one current on another.

The two types of measuring instruments belonging to this class are the moving-coil dynamometer type and the induction types, different forms of each of which will be described later.

Undoubtedly, the most important application of the wattmeter is in the measurement of electrical power in alternating-current circuits, in which it is difficult to get the true power otherwise.

By providing any of the instruments referred to in the preceding pages with a long pointer, terminating in a pencil or pen, and also with a light drum rotated very slowly by clock-work, and with a paper chart wrapped round it for the pencil to rub against, we obtain a fourth class of measuring instrument, called either a *recording ammeter*, *recording voltmeter*, or *recording wattmeter*, as the case may be.

Such recording instruments are useful when it is desired to see, or have a *permanent record* of the value of a varying quantity at any instant, say, during the day or night.

Further, we have to consider one of the most important of measuring instruments, namely, the electricity-supply meter, of which there may be said to be two kinds: (a) those which integrate or sum up the products of the current and time throughout every instant of the day, and which are termed *coulomb-* or *ampere-hour meters*; (b) those which integrate or sum up the products of the watts absorbed in any circuit and the time during every instant of the day, and which are called *energy-* or *watt-hour meters*, though less often *erg-* or *joule-meters*.

These two kinds of meters are sometimes called integrating ampere-hour and integrating watt-hour meters.

A general discussion of these and the other types of measuring instruments above mentioned, together with the advantages and disadvantages of the various forms, will be found given, somewhat in detail, at the commencement of the several chapters dealing with the particular classes of instrument.

It may be well to notice here, before passing on, that the term "recording wattmeter" is sometimes applied to an energy meter, *i.e.* an integrating watt-hour meter.

The term thus applied is incorrect, for the last-named instrument measures energy, *not power*. In fact, it does not indicate in the least what the maximum, minimum, or even the mean power in watts has been. It is important, therefore, to clearly understand the difference between power and energy, to appreciate that between a recording power- or watt-meter and an energy or integrating watt-hour meter. The relation of one to the other will best be remembered from the fact that

$$\text{Energy} = \text{Power} \times \text{Time}.$$

We may now pass on to the consideration of some important details pertaining to the construction of measuring instruments in general.

Controlling Forces.—It follows, perhaps without saying, that every electrical indicating or measuring instrument has some moving part or system which, when actuated by the current to be measured, is capable of taking up some temporary position of equilibrium between two positions of rest—one when no current flows, the other when the moving system will move no farther, however large the current or deflecting force. Or, in the case of an electricity meter with rotating parts, these are capable of rotating at some temporary constant speed between two extremes—one that of rest, the other the racing speed.

In all these instruments, it is absolutely necessary to provide and insert a *controlling force*, to oppose and control the actuating force, so as to cause the deflection or speed of the moving part, as the case may be, to be \propto to the actuating force. If this were not done, the moving part would deflect into the second position of rest at once, or race, as the case obtains, and no useful result would follow.

The controlling forces employed for this purpose are:—

- (1) The twist or pull of either a helical or spiral hair-spring.
- (2) The torsion of either a metal or silk-fibre suspension.
- (3) The attraction of gravity.
- (4) The attraction of permanent steel magnets.
- (5) The attraction of an electro-magnet temporarily magnetized by the whole, or a portion, of the current to be measured.
- (6) The electro-magnetic action of currents, induced by either permanent or electro magnets, in a conductor attached to the rotating system. This is commonly termed magnetic or Foucault damping.
- (7) The mechanical or air friction of a fan rotating with the system.

Every instrument is provided with one of these methods of control, 1-5 pertaining to am-, volt-, and watt-meters, ordinary or recording, while 6 and 7 refer only to electricity meters. It will therefore be well to compare the advantages and disadvantages of these several methods of control.

The first is an extremely common and important form of control, of which there are two variations. The helical form of spring is used only on a few kinds of instruments and in one of the two ways possible, *e.g.* to control by an *axial* extension, as with the soft-iron plunger of the Kohlrausch ammeter, or with the fine-wire moving coil of the Kelvin periodic integrating meter, p. 248. When used thus it should be remembered that any *axial* extension or elongation, within wide limits, is directly \propto to the force exerted.

The control by torsion or twisting up of one end of this form of spring, relatively to the other, is employed in the instruments described on pp. 62 to 71, and when so used it should be remembered that

The force of torsion is directly \propto to the angle of torsion.

The spiral hair-spring is largely used in instruments provided with a spring control, and the law just stated holds equally true for the torsion of such a spring. Speaking generally, for the successful action of either form of spring, but more especially the last named, the turns should be uniformly spaced, and should not touch one another at any stage of their action.

The strength of either form of spring will be increased by decreasing the number of turns, or by increasing the section of the material with which they are wound.

When employing either type for the control of an electrical instrument it is highly desirable, and in some cases absolutely necessary, that some hard and springy non-magnetic material, such as phosphor-bronze, should be used to wind them with. This is due to the fact that, if made of steel, they are liable to become strongly magnetized and stick, or become sluggish in their action. This, being indefinite in amount, will vitiate the instrumental readings.

The second form of control, viz. that of the wire or fibre suspension, is restricted almost entirely to laboratory or stationary instruments for testing purposes. An example of this control is to be seen in the instrument described on p. 144. An *increase* in the *section* or *decrease* in the *length* of the suspension will each increase the torsional resistance of it. For a given suspension the torsion is \propto to the angle of deflection.

The third form of control, viz. the attraction of gravity, is very largely used, and, when it can be applied, is one of the most satisfactory. It has the great advantages of being absolutely constant, and of being a much cheaper form of control than any other. An instrument employing it, often termed a "gravity" instrument, is usually cheaper to make than one with any other method of control. The main disadvantage of the gravity type of instrument is that any change in the quantity being measured is not readable quickly enough, owing to the oscillatory nature of the motion of the moving parts, unless damped by a device working on the principle of number 6 or 7 above. Methods 2 and 3 perhaps have the disadvantage that the instruments require to be very carefully levelled so that their pointers float exactly opposite zero. For stationary work this, however, is no disadvantage.

The fourth method of control is not much used now, but we have an instance of its use in the present-day instrument described on p. 55.

It has the disadvantage that in the presence of powerful external magnetic fields the magnetism is liable to be temporarily, or even permanently, affected and changed, thus either temporarily or permanently altering the sensibility and calibration of the instrument without, probably, the knowledge of the user. To partly get over this difficulty, the electro-magnetic control was

devised. This, however, is objectionable; for, since the control consists of soft iron surrounded by coils of wire, through which the whole, or part, of the main current flows, such an instrument exhibits a large amount of magnetic lag—creeping or residual magnetism—which will cause it to read differently according to whether the current is rising or falling. Further, in consequence of the residual magnetism, a reverse current sent for a short time through the instrument diminishes the subsequent indications for small direct currents.

The two remaining methods of control mentioned on p. 6 apply only to rotatory measuring instruments, *i.e.* to the motor class of electricity meter, and will therefore be considered in the chapters dealing with such meters.

Magnetic Shielding.—Mention has already been made of the fact that some instruments with certain forms of control are more easily affected by external magnetic fields than others.

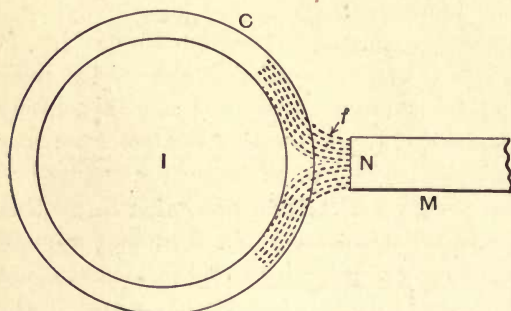

Fig. 1.—Effect of Iron Case in shielding Instruments from External Magnetic Fields

To get over this difficulty and disadvantage, the moving or working parts, in the case of some instruments, are covered by a soft-iron band or shield inside the usual brass containing-case. More often, however, the internal parts are enclosed in an *iron*

case (instead of a brass one), this being black-enamelled and having nickelled parts, with usually only a slit in the front for the scale.

The effect of the iron case is shown diagrammatically in fig. 1, which represents, we will suppose, an instrument having internal parts *I* capable of being affected by outside magnetic fields *M*. With an iron case *C* of appreciable thickness, the lines of force *f* are unable to cross the iron and so get into the interior, but follow a path in the case as shown, thus in no way influencing the working of the moving parts *I*.

We may now perhaps with advantage turn our attention to the consideration of the solenoids and actuating coils employed in electro-magnetic measuring instruments. Of these there are two

forms—one with hollow interiors or air cores, the other with iron cores.

The former is usually termed a solenoid when its axial length is not small compared with its diameter, while the latter may be called an electro-magnet.

Solenoids.—When used for the purpose under consideration these are not usually long, and the complete calculation of the field at any point inside the short helix is a somewhat difficult matter. For most practical purposes we have this formula for the magnetic field F at any point near the centre:—

$$F = \frac{4\pi}{10} AT;$$

where A = the current in amperes and T the turns per unit length.

In this connection it should be remembered that the magnetic field inside a solenoid is strongest at its centre C , where it is practically uniform. Since, however, there is no iron to guide the lines of force they leak out sideways, at or near the ends, and are therefore more dense at the sides S than near the axis A of the solenoid, consequently the field is stronger at the sides S than at A .

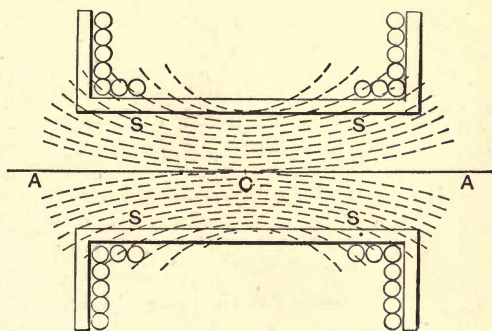

Fig. 2.—Magnetic Field produced by a Short Solenoid

Thus a movable piece of iron extending the whole length of a short

solenoid will be attracted into the densest part of the field, *i.e.* to the sides, whilst a short piece would move towards the centre.

From fig. 2, which shows the approximate distribution of the field due to a short solenoid, it will be seen that the central internal cross-section of the solenoid contains practically all the magnetic lines generated by it, which is not the case if taken at the ends AA .

For all sizes of solenoid, except when the diameter exceeds about half the length of the solenoid, the strength of field at the centre C is practically independent of the diameter of the solenoid inside.

Referring to the formula on p. 9, the numerical coefficient $4 \frac{\pi}{10}$ is a constant, and = approximately 1.25.

Hence $F = 1.25 A.T$ approximately,

or $F \propto A.T$, *i.e.* the *ampere turns*, as this product of the amperes into the turns is called.

Obviously this product, and therefore the same field, can be obtained in any number of different ways, *e.g.* by a small current and large number of turns, or by few turns and a large current.

In the case of a solenoid or electro-magnet of a given length, wound with a certain gauge of insulated wire, there is a practical limit to the number of layers for obtaining the maximum magnetic field. This arises from the fact that, after a certain limit has been reached in the number of layers, the resistance of the coils increases so rapidly as to cause the current to decrease faster than the number of turns increases, with the result that the *ampere turns* decrease. This useful limit is reached when the outside diameter = twice the inside diameter of the coils.

Maintaining these proportions, the field strength can then be altered by employing either a smaller or larger gauge of wire. In most cases the length of covered wire needed to fill a certain bobbin would be required, and this can be at once obtained from a very simple relation, thus:—

Let L = total length of insulated wire required to fill a given bobbin,

d = diameter of insulated wire (covered),

l = available length of winding space between flanges of bobbin,

D = available depth of winding space radially,

r = radius of a mean turn of fully-wound bobbin;

$$\text{then } L = \frac{2\pi r l D}{d^2}.$$

If now R = total resistance of the wire on the bobbin in ohms,

d_1 = diameter of the bare wire,

ρ = the specific resistance of the material of the wire;

$$\text{then } R = \frac{L\rho}{\pi d_1^2} = \frac{4L\rho}{\pi d_1^2} \text{ ohms.}$$

With regard to electro-magnets, the cores should not only be made of the softest and purest iron obtainable, but should also be the thickness of the winding in diameter to give the best results as regards strength for a given magnetizing force applied.

Electro-magnets for use with alternating currents should have cores of the softest and purest iron obtainable, and in addition

these cores should be well laminated in planes parallel to the path of the lines, so that there is just no electrical connection between the different sections of the core. This lamination stops the circulation of eddy or Foucault induced currents, which tend to flow in planes perpendicular to that in which the lines flow, *i.e.* to that of the laminations. The blocking out of eddies prevents the core heating excessively, which would otherwise result from them, and makes the iron more susceptible to the rapid reversals of the magnetic field and alternating current.

An electro-magnet for use with alternating currents is less effective with a solid core than with a laminated core of the same dimensions, owing to (*a*) the demagnetizing effect of eddy currents, (*b*) their heating effect and consequent reduction of the permeability of the iron.

It was stated on p. 4 that the only difference between ammeters and voltmeters of the moving-needle, dynamometer, and induction electro-magnetic types, lay in the winding of their working solenoids, or magnets, as to gauge and number of turns, and not in their shape. Those employed in ammeters consist of a few turns of thick insulated copper wire or strip of low resistance to carry the main current, while those used in voltmeters are wound with a large number of turns of fine insulated copper wire of high resistance, and carry a very small or potential current.

The reason why ammeters must have a low resistance is that they must absorb the minimum amount of voltage, while voltmeters should have a high resistance so as to pass the smallest possible current and thereby not alter the potential difference between the points to which they are applied. Another condition of vital importance in voltmeters is that their resistance should be invariable, whence the current flowing through them will always be \propto to the E.M.F. at their terminals.

If a voltmeter is wound with T turns and passes a current A amperes when a potential difference V is applied to its terminals, then the total resistance R of its coil will be

$$R = T \cdot r_m$$

where r_m = resistance of the mean turn; consequently

$$A = \frac{V}{R} = \frac{V}{T \cdot r_m},$$

whence the ampere turns

$$A \cdot T = \frac{V}{r_m},$$

$$\text{or } r_m = \frac{V}{A \cdot T}.$$

The value of the product $A \cdot T$, *i.e.* the amp. turns, in some moving-coil permanent-magnet instruments averages about 300, whilst this figure becomes about 600 for ammeters, and about 400 for voltmeters of the electro-magnetic moving-needle type. Hence r_m can be obtained, and from it, by assuming an average value for the amp. turns, the diameter d of the bare wire to be used can be got very easily.

Thus if m = length of a mean turn, and s = sectional area of wire, then

$$s = \frac{m \rho}{r_m},$$

ρ being the specific resistance of the wire at the working temperature; but

$$s = \frac{\pi d^2}{4},$$

$$\therefore d = \sqrt{\frac{4s}{\pi}} = \sqrt{\frac{4m\rho}{\pi r_m}} = \sqrt{\frac{4m\rho}{\pi \frac{V}{A \cdot T}}} = \sqrt{\frac{4m\rho A \cdot T}{\pi \cdot V}}.$$

The linear measure of the different symbols being in the same units.

Sources of Error.—We may now consider, briefly, the sources of error which are common to all, or nearly all, the different types of instruments already named.

Firstly, then, there is the error in the calibration, owing to the standards employed in the two cases being different.

This error applies to all instruments, and cannot well be remedied except by recalibration.

Secondly, the errors due to friction at the pivots in all types of instruments which contain pivoted parts.

These can be minimized, though not eliminated, by making the weight of such parts as small as possible.

Thirdly, errors due to changes of temperature in all types of instruments containing high-resistance shunt coils, *i.e.* coils passing potential currents, such as that of the electro-magnetic voltmeter, the fine wire coils of wattmeters and electricity meters, &c.

This source of error being an important one, we will now consider it in some detail.

Let c be the current in amperes passing through the coil of any electrical measuring instrument having a total terminal resistance R , with a fall of potential across its terminals $=v$.

Then since the scale of any ammeter is graduated in terms of c which $=\frac{v}{R}$, any variation of R due to temperature or otherwise produces a corresponding and proportional one in v for the same value of c . Consequently the correctness of the scale reading of any ammeter is independent of the variation of its resistance R .

The case of the voltmeter is, however, different, for here the scale is graduated in terms of v which $=c.R$. The reading of such an instrument is essentially $\propto c$, which at a *constant voltage* v is a variable if R changes owing to alteration of temperature or otherwise.

Thus the accuracy of the readings of any voltmeter or instrument containing a pressure or fine-wire (volt) coil, depends upon the resistance R of its coil, and will only be correct when that resistance has the value it had when the scale was marked.

This will always be the case when the temperature of the coil is the same as it was at the time of calibration. Hence, with such coils, the temperature at the time of calibration should always be carefully taken and stamped on the instrument.

The change of temperature of a coil may occur in one, or in both, of two ways:—Firstly, it may be due to the temperature of the *atmosphere* in the room; secondly, it may be due to the *heating* of the coil from the passage of the current and the consequent expenditure of energy in it, an expenditure which appears in the form of heat.

The coil, therefore, should be so constructed that its resistance does not vary with changes of temperature.

Now, every material, within a certain range of temperature, changes its resistance by a perfectly definite amount on every ohm for each degree of temperature, which is called its "*temperature coefficient*" α . Also, every material possesses a perfectly definite resistance, at constant temperature, between opposite faces of a 1-inch or 1-cm. cube of it, termed its "*specific resistance*" ρ . Now, for copper α is large and ρ small, while for such alloys as manganin, eureka, constantan, &c., α is almost nil and ρ very large.

Hence, if the fine-wire coil is wound with such materials or alloys, the temperature error will be negligibly small.

Since, however, by using such alloys, the requisite total resistance can be obtained with a coil of very small compass, the coil may heat excessively owing to there not being sufficient radiating surface for dissipating the heat produced by the energy spent in the coil. This energy is $\propto c^2R$ watts.¹

The method employed for diminishing the heating error to a minimum, and making it practically negligible, is to wind the working coil of the voltmeter with copper wire so as to obtain a large magneto-motive force and deflection with least energy waste and P.D. across its terminals respectively, and to connect in series with this working coil, another, wound (say non-inductively) with such a material as manganin so as to have a large radiating surface. The

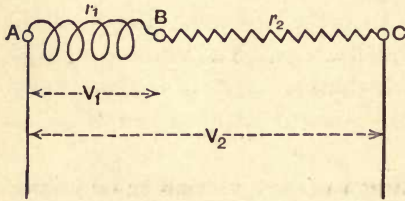

Fig. 3.—Principle employed for diminishing the Heating Error in Voltmeters

arrangement is shown in fig. 3. If, then, v_1 volts produce a deflection θ when applied directly to the working coil AB, and v_2 volts the same deflection θ when applied to the combination AC of which A and C are now the terminals, and if $r_1 r_2 =$ resistances respectively of working and of extra coil;

Then

$$\frac{v_1}{v_2} = \frac{r_1}{r_1 + r_2}.$$

Under these circumstances, though r_1 may vary considerably, it is so small a fraction of r_2 that $r_1 + r_2$ practically remains constant at all temperatures.

A further advantage is that this principle enables high voltages to be measured when only a low-voltage instrument is available.

If α_1 is the *temperature coefficient* of the working coil AB, and α_2 the " " " " extra coil BC; then the " " " " combination AC will be

$$a = \frac{\alpha_1 \pm \frac{r_2}{r_1}}{r_1 + r_2} = \frac{\alpha_1 r_1 \pm \alpha_2 r_2}{r_1 + r_2} \text{ per ohm per } 1^\circ \text{C.}$$

¹ At the present day an electro-magnetic voltmeter of the moving-needle type may expend as little as 2.0 watts, and a moving-coil permanent-magnet instrument as little as 0.01 watt in their fine-wire coil circuits.

The negative sign is only used when the material of the extra coil BC has a negative temperature coefficient, and then the sum $r_1 + r_2$ will be perfectly constant at all temperatures

$$\begin{aligned} \text{if} \quad & a_1 = \frac{r_2}{r_1} a_2, \\ \text{i.e.} \quad & r_1 a_1 = r_2 a_2. \end{aligned}$$

From the formulæ on p. 14 it at once follows that if

r = resistance of voltmeter and v any reading in volts at the time of calibration
and $R =$ " " " and $v =$ " " " at any other time;

$$\text{Then} \quad v = v \cdot \frac{R}{r} \text{ volts.}$$

Further, if t and T be the temperature in degrees C. at which r and R are measured respectively, we have

$$R = r \{1 + \alpha (T - t)\}.$$

Compensating Devices.—Comparatively few instruments will, with the same scale graduations, measure accurately direct or alternating currents, and P.D.'s of any periodicity. Examples, however, of such measuring instruments are described on pp. 62 and 72. Those which are capable of measuring both kinds of current, but require a slight alteration in their construction, or a compensating device, are the moving-needle electro-magnetic instruments.

One method of compensation employed in ammeters and voltmeters is to shunt the working coil with an inductive choking coil, which, with continuous currents, shunts off some 5% of the current from the working coil. When the instrument is used for alternating currents the choking coil, by reason of its inductance, creates a back E.M.F. in its own circuit, thus allowing only some 2% of the current to be shunted, leaving the additional 3% for the working coil, which is sufficient to raise the readings to the correct effective value.

This choking coil may merely consist of an ordinary solenoid wound on a well-laminated soft-iron wire core of about $2\frac{1}{2}$ times the length of the coil. The protruding wires of the core are then bent back over the outside of the coil and interlaced so as to form a closed magnetic circuit for the lines to flow in. The coil is then simply connected in parallel with the working one of the instrument. This is merely an addition to the ordinary direct-current instrument; and with regard to alteration of construction, the only thing done is

to reduce the amount of iron in the moving parts to a minimum and to have it of the softest and purest possible kind. Where possible, insulating or non-metallic and non-magnetic material should be substituted for all metallic parts of the instrument; and when impossible, such metal parts should be slotted to reduce eddy currents.

Another method of compensating alternating-current electromagnetic ammeters to read correctly at any periodicity, consists in winding on the ammeter bobbin two or three thousand turns of very fine insulated copper wire having a high resistance. Over this is wound the ordinary thick winding of the instrument.

This fine-wire winding is connected to the terminals of a condenser of suitable capacity; and, by varying this and the number of turns on the fine winding, the instrument can be compensated within extremely close limits, so as to read correctly for all periodicities up to, say, 130, and also for continuous currents with one and the same scale graduation. The action is as follows:—

The alternating current in the main coil induces a current in the fine-wire coil, and this, by reason of the action of the condenser, creates a magnetic field which is in phase with that given by the main coil.

This auxiliary field increases with increase of periodicity, while that of the main coil diminishes, though less rapidly; thus, an

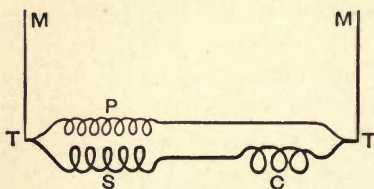

Fig. 4.—Transformer Compensating Device for enabling Direct-Current Instruments to measure Alternating Currents accurately.

instrument which has this device, and reads correctly on direct-current circuits, will, when used with alternating currents, have the induction inside raised to the same mean effective value by this compensating device, whence the scale readings will also be correct with alternating as with direct currents.

The same device is also applied to voltmeters with equally good results.

By another method, entailing the use of a very small transformer, direct-current voltmeters of the class above mentioned are also corrected for use with alternating currents so as to read correctly at all periodicities up to about 130 ~ per sec. Fig. 4 indicates the arrangement.

The primary P of this transformer is placed across the mains

M and the secondary S in series with the working coil C of the instrument, TT now being the voltmeter terminals.

Then matters are so adjusted in regard to the ratio of the voltages of P and S that the E.M.F. of S just neutralizes the back E.M.F. of C due to its self-induction when used with alternating currents; and then C acts as though it had no inductance, at the same time passing the same mean current as passed when continuous currents were used. Hence the voltmeter reads the same for alternate as for continuous currents.

CHAPTER II

MOVING-NEEDLE ELECTRO-MAGNETIC INSTRUMENTS

We shall in the present chapter confine ourselves to the first of the four different types of electrical measuring instruments constituting the electro-magnetic class, viz.:—

- (a) The moving-needle type.
- (b) The moving-coil—dynamometer type.
- (c) The moving-coil—permanent-magnet type.
- (d) The induction type.

The moving-needle type comprises all instruments in which a piece of soft iron, free to move, is sucked or attracted from a weaker to a stronger part of the field due to a main solenoid, suitably wound.

The controlling force used may be either gravity or that due to a spring, or in one or two instances that of a permanent steel magnet (*vide* p. 55).

With some slight modifications, this type of instrument can be used for alternating-current work as well (*vide* pp. 29 and 59), the principal advantage lying in the simplicity of construction. The errors mentioned on p. 12 apply to these instruments, and in addition they are liable to errors due to—

(1) The alteration in the strength of the permanent magnet in cases where this is used as the control (*vide* p. 55).

(2) The sensibility of the instrument being temporarily altered by external magnetic influence; this is minimized by the magnetic screening mentioned on p. 8.

(3) The alteration of periodicity in alternating-current instruments, compensated for as indicated on pp. 29 and 37.

(4) The change of temperature of the instrument in the case of voltmeters. The method of minimizing this is given on p. 14.

(5) The same current giving different deflection, depending on whether it is rising or falling.

In some instruments having comparatively massive moving needles of hard iron this last error may amount to as much as

20 to 25 per cent. In such cases the deflections with decreasing currents are always higher than for increasing currents of the same actual strength, owing to some of the magnetization set up at the higher currents being retained by the iron in the form of residual magnetism, which consequently assists the lower magnetizations of smaller currents. This error is well illustrated by the following table of readings, taken with a well-known direct-current voltmeter of the moving soft-iron needle form, the standard employed being a moving-coil permanent-magnet voltmeter which can show no such error as No. 5 above.

Reading on Standard.	Reading on Voltmeter tested—	
	Ascending.	Descending.
10	10	12.5
20	20.1	24.5
30	30.3	36.0
40	40.0	46.9
50	50.2	56.0
60	60.3	64.8
70	70.5	73.1
80	80.9	81.9
90	90.8	90.8

It is seen from these readings that this instrument reads 25 per cent too high at the lower readings after the voltage had been reduced from the maximum. In fact the voltmeter may correctly be said to be a most unsatisfactory instrument in this particular case. It is not the case, however, with many instruments of this type, which often show quite a small "magnetic lag".

The moving-coil dynamometer type is eminently suitable for alternating-current work; for, containing no iron in the working parts, it is independent of variation, of periodicity, and in most cases of "wave form" of the circuit. It is equally accurate on either direct- or alternating-current circuits; but is subject to error 2 above, in addition to those enumerated on p. 12. The control employed is necessarily that of two springs, set so that one uncoils as the other coils, thereby avoiding alterations of zero through changes of temperature affecting the springs.

The main advantage is that this type contains neither iron nor permanent magnets in its working parts.

The moving-coil permanent-magnet type is applicable to con-

tinuous currents only, and has necessarily a spring control, while a larger deflecting torque is obtained with this than with any other form of electro-magnetic instrument.

Its possessing a permanent magnet has been urged as an objection against this type. Such objections are rather imaginary than real; for, with the present methods permanent magnets can be made to retain their original strength almost from year to year. This constancy of the permanent field is obtained by a very careful process termed "ageing"; but undoubtedly a possible source of error may lie in the partial demagnetization of this magnet, causing an alteration of sensibility. This type is subject to error 4 above, in addition to the errors noted on p. 12, but it has the important advantages of being dead-beat, and of having uniformly-divided scales from end to end.

Ammeters of this type have the advantage of the simplicity afforded by the potential system of measuring current, though errors are liable to creep in here unless guarded against, owing to temperature not affecting the shunt and instrument parts proportionally.

The induction type is an instrument of very recent origin, and possesses some important advantages:—firstly, no electrical connection is needed to the moving parts; secondly, these moving parts are of the simplest description.

Such instruments are subject to errors 3 and 4 above, in addition to the errors noted on p. 12. They have a spring control usually, but in some cases a gravity control is employed.

We will now proceed to consider the well-known forms of the electro-magnetic class of electrical measuring instrument, and for this purpose each will be treated quite independently of the other.

The Atkinson Ammeters and Voltmeters

These instruments, supplied by Atkinsons' Testing Works, Cardiff, have a gravity control; and they possess many important features not embodied in other instruments working in almost precisely the same way. Their construction, which is of a distinctly novel nature, will be understood from a reference to the part sectional elevation of the instrument shown in fig. 5. The moving part, comprising what we may term the needle and pointer, consists of a sealed glass tube G of the form of an ordinary test-

tube sealed at the top D. This contains an hydrometer or float F, into the stem and body part of which is fixed a soft-iron wire or needle N. The float F is immersed, and is capable of moving up and down, in a liquid L having a constant density at all temperatures. This is obtained by the use of a saturated solution of a special salt of which a few crystals B are left in the bottom of the tube G. The particular salt employed has the property of dissolving out in such proportion that by this action the change in density of the liquid by change of temperature is compensated for.

The float F normally stands with the top of the stem just out of the liquid L as shown at H, and fits the outer tube G quite freely. It is kept from contact or capillary sticking by three glass points P on the bulb, and therefore floats centrally without touching. Notwithstanding this the magnifying effect of the outer glass of G and liquid L, makes the indicator band A to appear as if it was of the full diameter of the outer tube G. The pointer or indicator of these instruments consists of a band A having white and black parts meeting, and the reading is taken at the point where their junction strikes the scale. The outer tube G can be raised or lowered by means of the milled-headed screw *m* and the band A thus adjusted to zero.

This band, which is the only part of the moving float that is

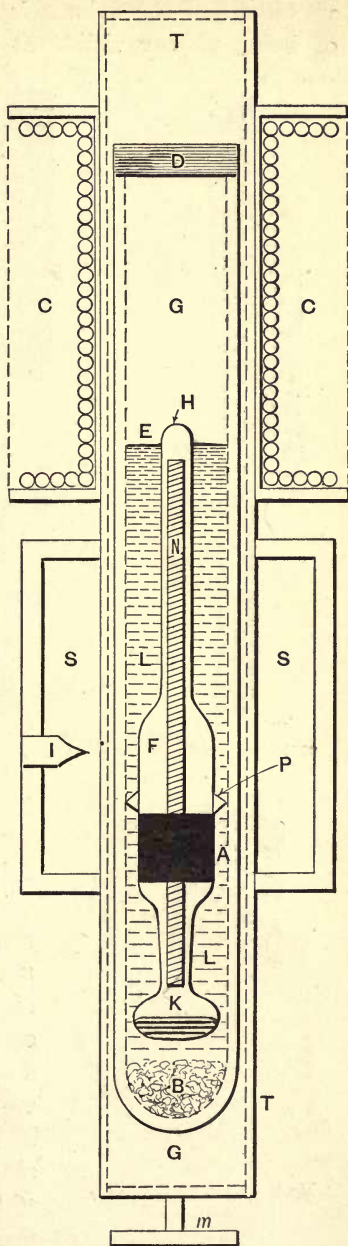

Fig. 5.—View of Working Parts (Atkinson Ammeter or Voltmeter)

visible when the tube G is in the instrument, has the advantage of being plainly visible at a greater distance than the ordinary



Fig. 6.—Tube containing the Float

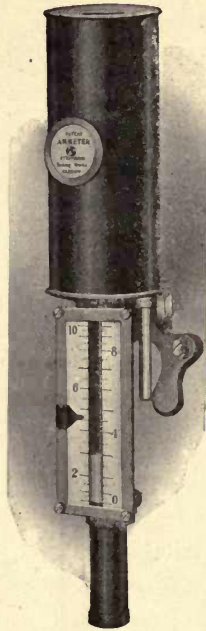

Fig. 7.—Complete Atkinson Ammeter

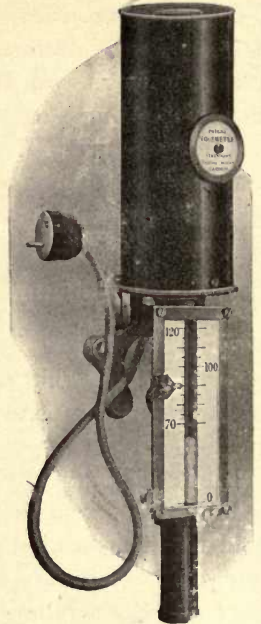

Fig. 8.—Complete Atkinson Voltmeter



Fig. 9.—Extra Resistance for Voltmeter

form of instrument pointer. The glass tube G is placed inside the main brass tube T of the instrument so that the needle N protrudes about $\frac{5}{8}$ inch into the lower end of the working solenoidal coil C which carries the current, the surface of the liquid being at E. A frame S carries the graduated scale and one side a sliding index I capable of being placed opposite any desired reading of the scale. The action of the instrument is at once obvious. When a current flows round the coil C, the iron needle N and its containing float F are sucked up into it, against the

force of gravity, by an amount which is a measure of the current strength in C. Thus it will be seen that by this ingenious device,

without the use of costly and delicate jewelled pivots, a damped or dead-beat movement of the moving part of the instrument is obtained which is practically free from all friction. The instruments are shielded by an iron case from external magnetic fields, and are made for almost any current or voltage, and to fix to a switch-board, their total height over all being 18 inches. Fig. 6 shows the tube G with contents from an actual instrument, while figs. 7 and 8 show the general form of a complete ammeter and voltmeter respectively. Fig. 9 shows the separate high resistance used in series with the voltmeters, with the flexible wire to make connection.

Pocket Ammeters and Voltmeters

It is sometimes necessary, particularly for the smaller classes of work, to have small portable instruments which can be carried

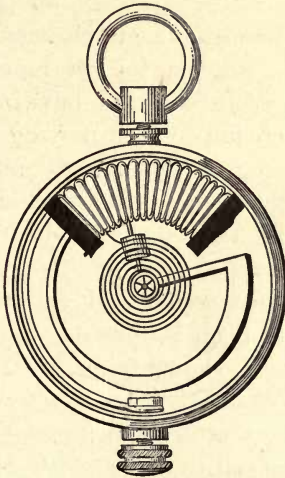

Fig. 10.—View of Working Parts of Ammeter

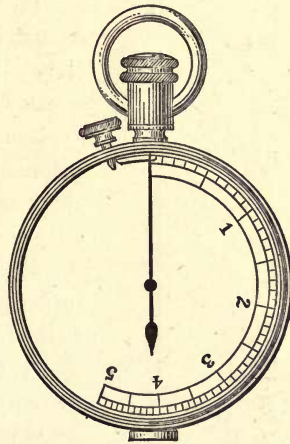

Fig. 11.—General View of Pocket Voltmeter

about easily. A form suitable for this purpose is that shown in figs. 10 and 11, the former indicating the internal construction of the instrument, in this case an ammeter, and the latter the general appearance with scale in position. As seen in fig. 10 the instrument consists of a curved tapering soft-iron strip, carried at its wider end by a radial arm on a spindle running in jewelled centres.

The pointer is fixed to the spindle, which is controlled by the spiral hair-spring seen in the centre. The curved plunger is sucked

into the curved solenoid seen at the upper part of the case, causing a deflection depending for its magnitude on the current strength.

The terminals of the instrument, fig. 10, *i.e.* of the fixed curved coil, are shown at the bottom of the case and at the top, which may also serve for the ring to attach the watch-chain to if necessary.

Fig. 11 shows a voltmeter of the same type in which the terminals are both at the top. The only difference in construction between the ammeter and voltmeter being that the voltmeter coil is wound with a large number of turns of fine wire in place of a few turns of thick wire, as shown in the ammeter, fig. 10. The

instrument will go quite easily into a watch-pocket; and, as is seen, has a fairly open scale of divisions.

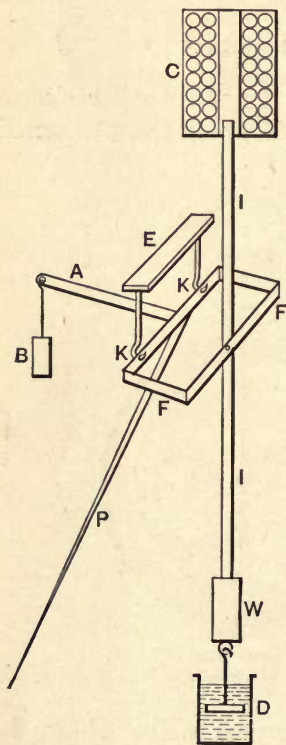

Fig. 12.—Working Principle of Kelvin Ampere and Volt Gauges

Kelvin Ampere and Volt Gauges

These ammeters and voltmeters possess a soft-iron plunger for the moving part, they are dead-beat, and have a gravity control. Owing to their moving magnetic system being always vertical, and to the intense field set up by the working solenoid, they are found to be but little affected by external magnetic fields.

The construction and action will be understood from a reference to the symbolical sketch shown in fig. 12. It consists of a vertical slate back or base (not shown), to which is attached a special form of solenoid or coil *C*, wound with wire in the small ranges, but for larger currents built up of copper plates with mica insulation between them, and with its hollow interior vertical.

A brass bearing plate *E* supports a balance frame *F*, one side of which carries a thin soft-iron wire plunger *II* about 20 cms. long, the other an arm *A*, from which hangs a brass counterpoise weight *B*. Knife-edge hooks *K* support the balance at such a distance below the coil *C* that the top end of the core *I* is slightly entered into the coil. A brass weight *W*

hangs from the lower end of I and thus always keeps it vertical, preventing it from being attracted against the sides of the hollow coil C.

The light pointer P is attached to the side of the frame F which forms the axis of turning.

A dashpot D containing oil is placed below the plunger and weight w, and a light disc hung from the latter moves up and down in the oil, giving an aperiodic motion to the moving system. This type of instrument can be calibrated for either direct- or alternating-current use.

Fig. 13 shows the general form of an ampere gauge for 200 amps.

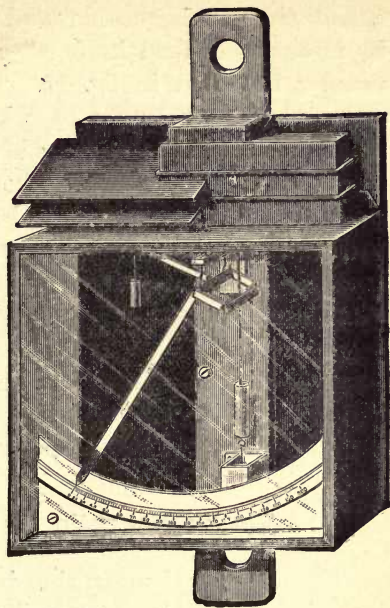

Fig. 13.—Kelvin Ampere Gauge

Kelvin Ampere and Volt Gauges (Sector Pattern)

These instruments also work on the solenoid and moving-plunger principle, and have a gravity control. They are provided with a damping arrangement similar to the one described in connection with the Kelvin gauges, which are very similar to the sector pattern under consideration.

The construction of the Kelvin sector-pattern gauge will be understood from a reference to fig. 14. As will be seen, the soft-iron-wire plunger is sucked *down* into the working solenoid, the top end of which can just be seen above the scale. It is suspended by

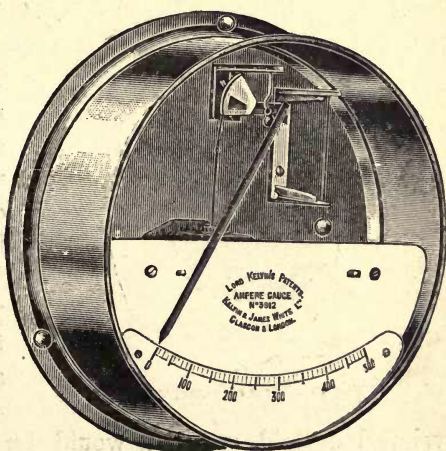

Fig. 14.—Kelvin Ampere Gauge (Sector Pattern)

of which can just be seen above the scale. It is suspended by

a fine wire which passes round a sector-shaped balance arm, hung by means of hooked knife-edges from a fixed bracket arm, in the manner indicated in fig. 12. The weight of the pointer, sector, and plunger is balanced by a knob which screws on an extension of the sector at the other side of the axis of turning.

A plummet line, seen to the right of the balance sector in fig. 14, enables the instrument to be carefully levelled. The coil is of special construction, giving a very strong and uniform field in its interior, and thereby enabling a scale of almost equal divisions throughout to be obtained, and reducing the effect of external magnetic fields to a minimum.

As in the case of the other form of gauge, the frictional error is reduced to a minimum through the employment of hooked knife-edges instead of jewelled centres.

Electro-Magnetic Ammeters and Voltmeters

These electrical measuring instruments, supplied by Messrs. H. Von Kramer & Co., Lower Weston, Bath, work on the moving

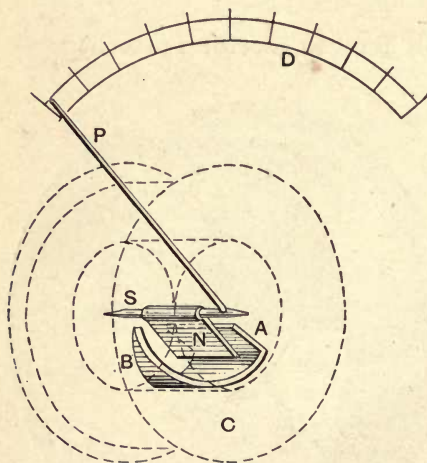

Fig. 15.—View of Working Parts

soft-iron needle and solenoid principle, and have a spring control. They are very similar to those described on p. 57, and the construction and action will be understood from a reference to the perspective drawing, fig. 15. *c* is the working solenoid, having a cylindrical aperture through its centre, and wound suitably for current or pressure purposes. Fixed inside this aperture is a small thin soft-iron strip *AB* bent and shaped as shown, but which, when developed or laid out flat, would form a triangular sheet having its apex at *B*.

The wide end *A* of this strip is bent so as to project nearly radially inwards as at *A*.

Pivoted concentrically with *c* in jewelled centres is a light steel

spindle *s*, to which is fixed a pointer *P*, and a small thin soft-iron plate, vane, or needle *N*. When *P* is at zero on the scale *D*, the movable needle *N* and plate *A* are close together and nearly parallel. When, however, a current passes through the solenoid *c*, they develop like polarity at the same end and repulsion ensues, the needle with its pointer being driven towards the apex *B* of the fixed triangular strip where the repelling action is not so great.

Its motion is controlled by a non-magnetic spring (not shown). *AB* and \star are made of the softest iron obtainable, in order to reduce hysteresis errors to a minimum. Fig. 16 shows the general appearance of a complete instrument of this construction.

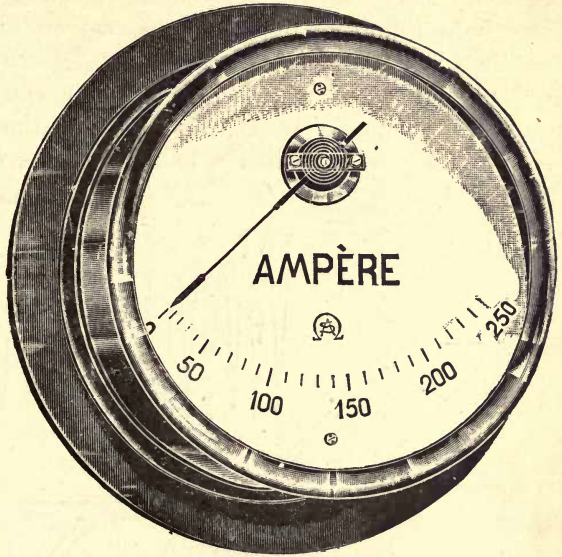

Fig. 16.—Complete Ammeter (Kramer & Co.)

The "E.E.C." Universal Ammeters and Voltmeters

These instruments, made by Messrs. Everett, Edgumbe, & Co., of London, have for the moving system a soft-iron needle. They possess a gravity control, and are fitted with an air-damping device.

Fig. 17 shows an elevational diagram of the arrangement in a voltmeter of this type. The actuating or working solenoid or coil *c*, in this case wound with fine insulated wire, is supported on a bracket or frame *F* with its magnetic axis vertical. The coil is of a specially flat shape in order to give as concentrated a field as possible with a minimum waste of energy. For ammeters above 20 amperes the coil is wound with bare copper strip, each turn being insulated from the next by tape. The moving-needle plunger *N*

consists of a very thin soft-iron plate, shaped approximately as shown, and carried on a horizontal spindle running in jewelled centres. These centres are carried by a lug at the back and the arm *a* in the front, in each case cast on to the frame *F*. The needle *N* is capable of being sucked up into the narrow slit forming a hollow space through the interior of the coil *c*.

To the spindle is rigidly attached the light pointer *P* of aluminium provided with a balance-weight *b* carried on a short

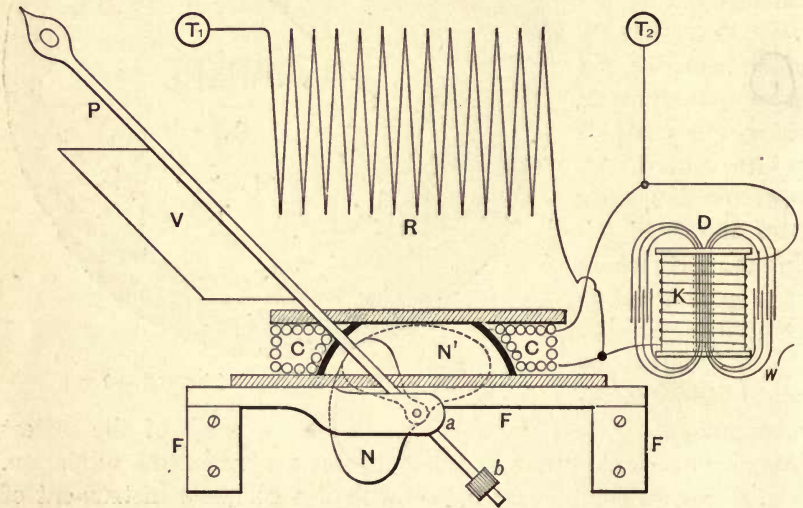

Fig. 17.—Working Principle of "E.E.C." Ammeters and Voltmeters

extension of *P*. This weight is for the purpose of balancing the weight of *P* and *N*. A high non-inductively wound resistance *R* is connected in series with the working coil *C*, and is placed at the back of the instrument, being so wound that it can radiate any heat generated in it, freely. Thus *R* and *C* are in simple series with each other across the terminals $T_1 T_2$ of the instrument. A very thin, large-sized, aluminium vane *V* is attached to the pointer *P* with its plane perpendicular to that in which the pointer moves, which by its cushioning action on the air produces a fairly good dead-beat motion of the pointer and its moving system.

The whole of the internal fittings together with *R* are mounted on a highly-insulating back or base, and are enclosed in an iron case which protects the working parts from external magnetic influence. The action of the instruments hardly needs explaining,

and consists merely in the coil *c* sucking the soft-iron plate *N* up against the force of gravity by an amount proportional to the strength of the current in the coil, the position *N'* being the final one for the needle corresponding to a little over a full scale deflection of *P*. The instrument is provided with a special device for enabling it to read correctly when used for both direct and alternating currents indiscriminately. This consists of a suitably wound choking coil *D* about $1\frac{1}{2}$ inch long and 1 inch diam., connected

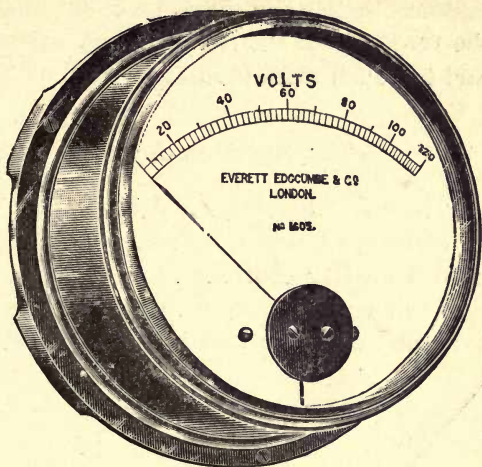

Fig. 18.—Complete "E.E.C." Voltmeter

as a shunt to the working coil *c*. The choker merely consists of a bobbin of fine wire having an iron core composed of fine wires *w*, which are bent over as shown to complete the magnetic circuit. This choking coil with direct currents shunts off say 5 per cent of the current from *c*, but with alternating currents only some 2 per cent, leaving the additional 3 per cent for the coil *c*, and so raising the readings to the correct effective value.

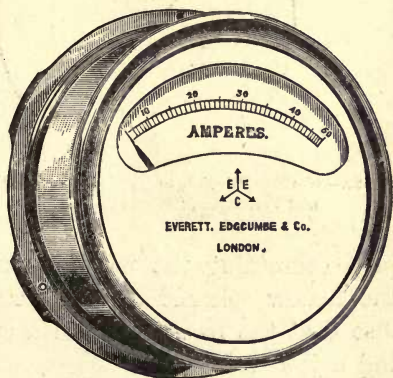

Fig. 19.—Complete "E.E.C." Ammeter

Fig. 18 shows the general appearance of the voltmeter, and fig. 19 of an ammeter of this type; and from these the kind of scale obtained is easily seen. The difference in front appearance represents two grades of manufacture merely. The amount of iron in the soft-iron plunger is as small as possible, and is of the softest description, thereby reducing the hysteresis to a minimum. The shape of the coil is such that its self-induction is very small, and also that stray fields have little or no effect on

the readings of the instrument. The makers claim, therefore, that, for all practical purposes, the instruments can be used indiscriminately for direct or alternating current, the difference in the readings for the same current strength in the two cases being said to be not more than 1 per cent.

The Harrison Ammeters and Voltmeters

These instruments, made by Messrs. Everett, Edgeumbe, & Co., of London, possess a soft-iron needle for the moving part, and have a gravity control.

Their construction is very simple, as is shown in fig. 20, which is an end elevation, and in fig. 21, a side elevation of the tubular

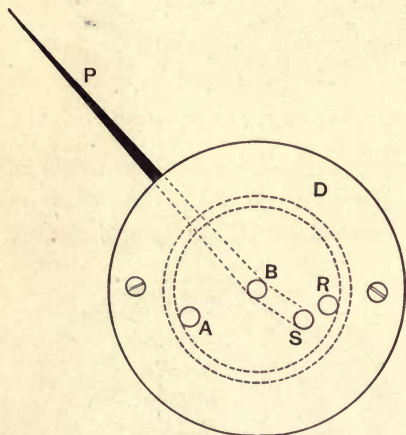

Fig. 20.—Working Principle of Harrison Ammeter and Voltmeter (End Elevation)

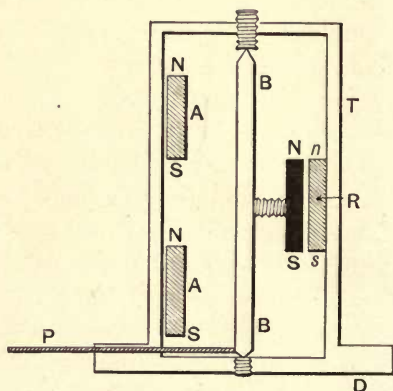

Fig. 21.—Side Elevation of Working Principle of Harrison Ammeter and Voltmeter

plug containing the moving part. The tubular plug fits inside the hollow solenoid or coil. *T* is a brass tube provided with a disc *D* at the front end, and a cross bar at the other, each carrying a jewelled centre.

Between these two centres works a steel spindle *BB*, which carries the pointer *P* at the front end, and a soft-iron rod or needle *NS* in the middle.

In the tube *T* are fixed two soft-iron attracting rods *AA*, and a repelling rod *R*, placed as shown relatively to one another and to the moving rod *NS*, which latter, as well as the pointer, moves through an arc of about 100°.

The action of the instrument will now be obvious. When a current passes round the coils which surround the tube T—A A, R, and N S are magnetized and develop the same polarity at those ends which point all one way, as shown fig. 21, consequently N S and R repel one another, while A A attracts N S, the resulting scale being nearly uniform.

Siemens Bros. & Co.'s Ammeters and Voltmeters

These instruments, made and supplied by Messrs. Siemens Bros. and Co., of London, possess a moving needle of soft iron and a gravity control. They are dead-beat, and are also shielded from external magnetic influence.

The principle on which they work will be seen from a reference to fig. 22.

The moving system consists of a thin soft-iron pear-shaped plate I pivoted on a horizontal spindle s running in jewelled centres C.

To this spindle s is also attached a light pointer P and a light wire w bent as shown, and carrying a light piston D, which works in a curved air-tube T.

This tube T is closed at the end B but fully open at the other A, and constitutes the air damping device for making the instrument dead-beat.

Fig. 23 shows a photo of the moving system complete by itself, comprising the soft-iron plate or plunger, the pointer, spindle, and curved rod carrying the piston disc at the end.

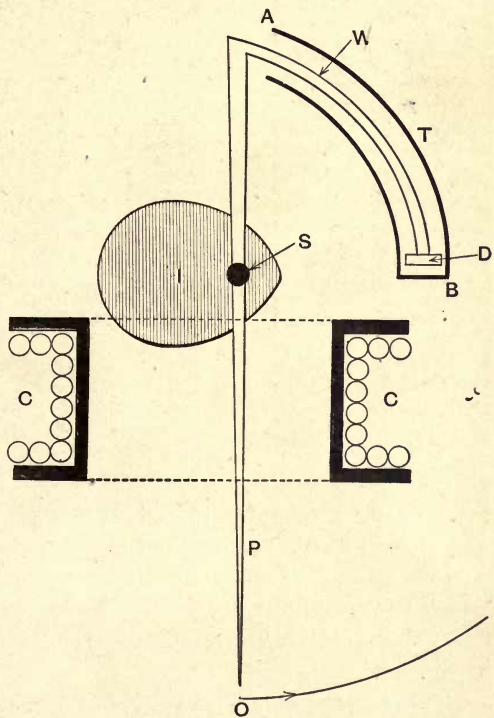

Fig. 22.—Working Principle of Moving-Needle Ammeter and Voltmeter (Siemens Bros. & Co.)

Referring to fig. 22 it will be seen that the plunger 1 is sucked down into the main solenoid C, which is rectangular in shape, and has a rectangular hollow or slot through its centre for the plate to work in.

In the case of ammeters for currents above 70 amperes the ends of the coil are terminated by flat copper bars to the ends of

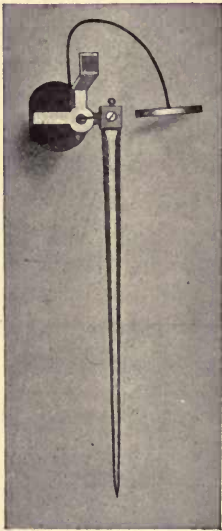

Fig. 23.—Moving System

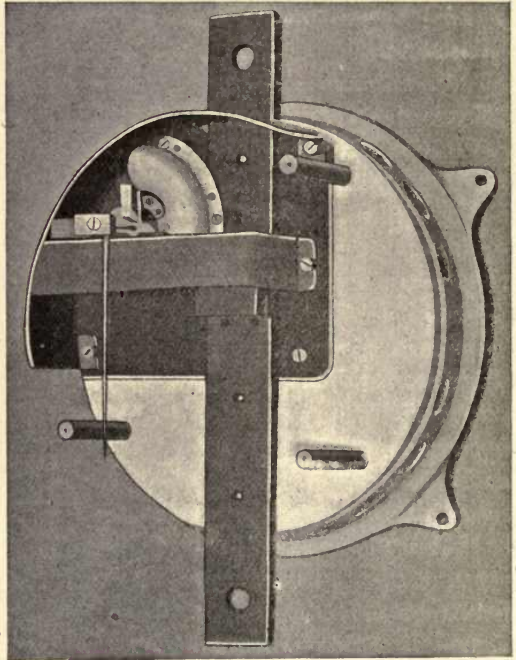

Fig. 24.—Interior, showing Magnetic Shield in position

which the terminals are fixed. These bars, with the holes in them ready for receiving the connecting bolts or terminals, are shown in fig. 24.

The instruments are provided with a soft-iron shield shown by itself detached from the interior and to the left of fig. 25. This is intended as a magnetic shield to give immunity from the effect of external magnetic bodies, but at the same time it acts as a guard against damage to the moving parts.

The shield is shown in position in fig. 24.

The general appearance of the complete instruments of this type and make—a voltmeter—is shown in fig. 26.

All ammeters of this make for 350 amperes and upwards are supplied with a current-reducing transformer, so that only potential

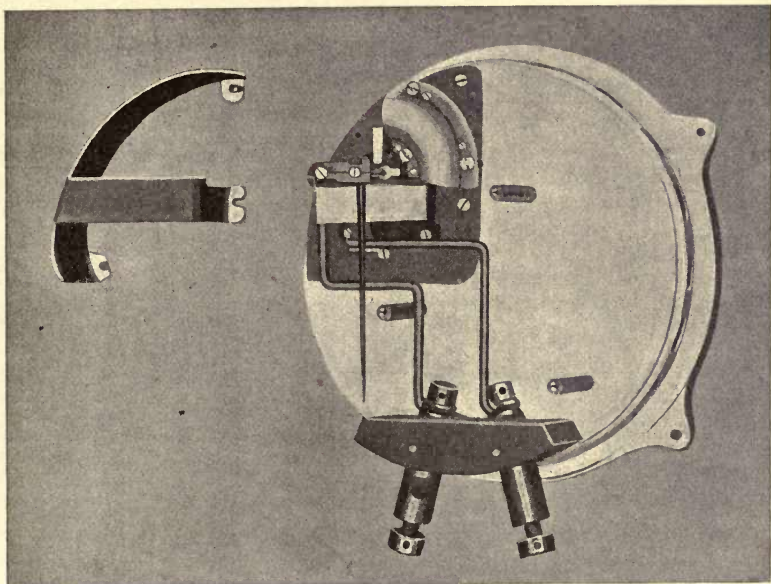

Fig. 25.—Interior, with Magnetic Shield detached

wires are required from the secondary of the transformer to the instrument, the primary or current coil being in series with one of the mains.

In the case of voltmeters for voltages above 800 volts a transformer is also supplied, which reduces the pressure at the instrument to 110 volts.

The "Evershed" Ammeters and Voltmeters

Messrs. Evershed and Vignoles, of London, make instruments having a gravity control, and which can be supplied either with or without a "dead-beat" action.

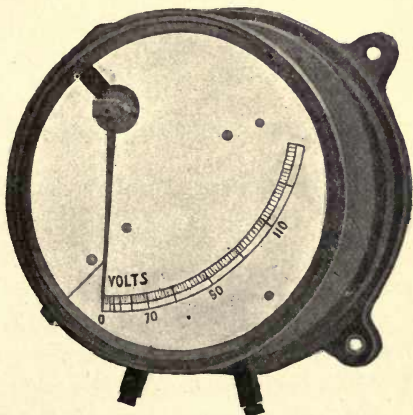

Fig. 26.—Moving-needle Voltmeter (Siemens)

Fig. 27 gives a perspective view, showing the principle on which they are constructed, and work.

A thin brass tube *T*, about 2 inches long and $\frac{5}{16}$ inch diameter, is closed at one end by a brass disc *B* which carries an agate centre *E* concentric with it.

The front end of *T* terminates in a brass ring *R*, to which is screwed a bracket arm *f*, carrying the front agate centre *v*.

Round the outside of the tube *T*, and about the middle of it, is wrapped a thin soft-iron sleeve *MK*, about 1 inch wide, the ends of

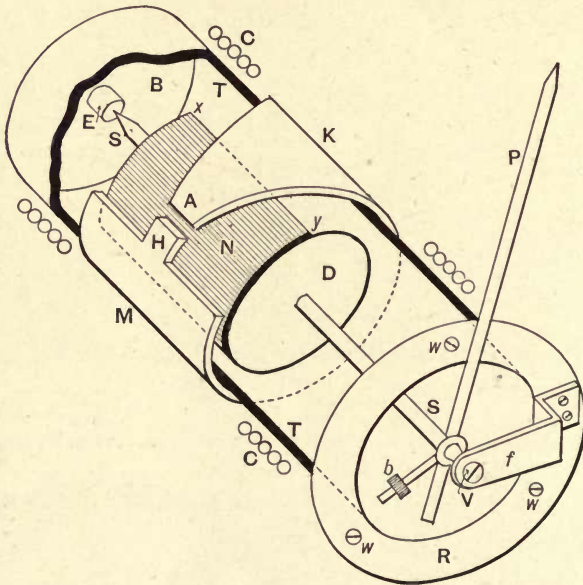

Fig. 27.—Working Principle of Evershed Moving-needle Instrument

which are necked or tapered down as shown at *H* and *A* to about $\frac{3}{16}$ inch in width, and approach one another to within about $\frac{1}{16}$ inch.

The true cylindrical part of this sleeve does not form quite a half cylinder.

Pivoted concentrically with *T*, and between the agate centres *E* and *v*, is a light steel spindle *s* carrying about its middle region a thin brass disc *D*. To the edge of *D* is soldered an almost half-cylindrical tube or plate of thin soft iron *N*, shown shaded and about 1 inch long, *i.e.* about the same width as the fixed part *M*.

The spindle *s* also carries the pointer *P* at the front end, and a balance-weight *b*.

The whole of this arrangement of tube T and sleeve MK is slipped into a coil or solenoid C C, wound on a bobbin some 2 inches long, which is energized by the voltage or current to be measured. Three small metal-threaded screws w fix the arrangement to the flange of the coil c. The tube T is shown cut away, for the purpose of depicting the interior more clearly, but actually it is nearly

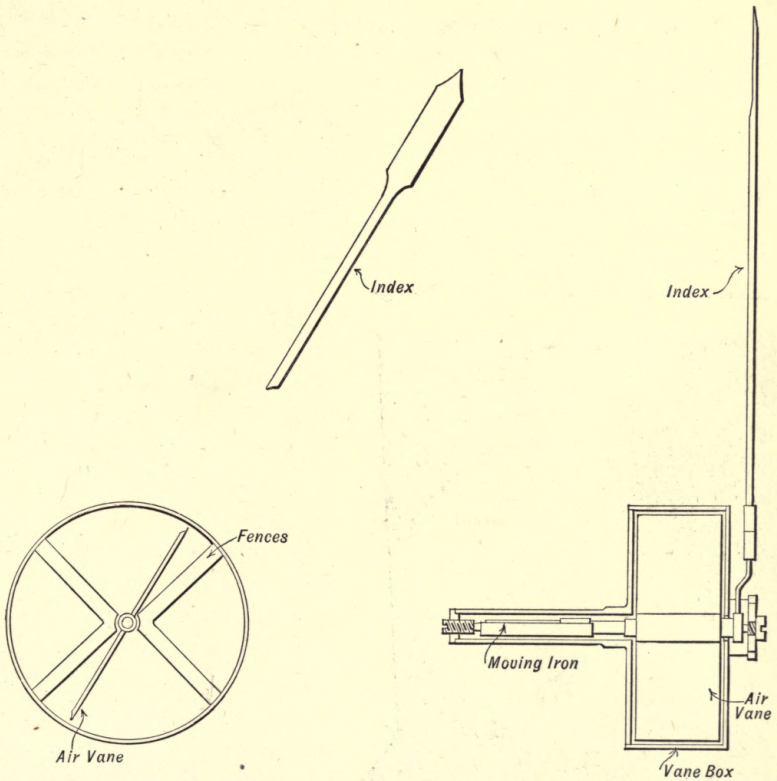

Fig. 28.—End View of Evershed Air Damper

Fig. 29.—Side View of Evershed Air Damper

closed except for a narrow strip cut out to enable the moving needle N to be seen and adjusted more easily. The action of the instrument is as follows:—The fixed sleeve MK offers a variable path to the magnetic lines that are produced by the current which flows axially through the coil c, while a certain amount of free magnetism is set up at H A. Now, when the pointer P is adjusted to zero for no current in c, the edge *xy* of the moving needle N is just a trifle above the gap at H A. When, however, c is energized

by the voltage or current to be measured, *N* is attracted so as to fill up the gap and recesses formed by the tapering of *MK* towards *H* and *A*, and the amount of turning depends on the strength of the current flowing in *C*, which is therefore indicated by the deflection of *P* on the scale (not shown).

The moving needle *N* and fixed sleeve *MK* are of course close together, and the action consequently when a current flows is, that *N* tries to form with *MK* a truly cylindrical iron tube, and this results from the repulsion of like poles set up in *N* and *MK*, the semi-cylindrical portions of which nearly cover one another at the start.

It will be seen from fig. 27 that the relative positions of *N* and *MK* are such that the gaps about *H* and *A* are nearly closed and the pointer *P* consequently nearly at a full-scale deflection.

The calibration of the instrument depends on the shape of the tongues *H* and *A* of the fixed sleeve *MK*, and also on the relative positions of this and *N* at starting.

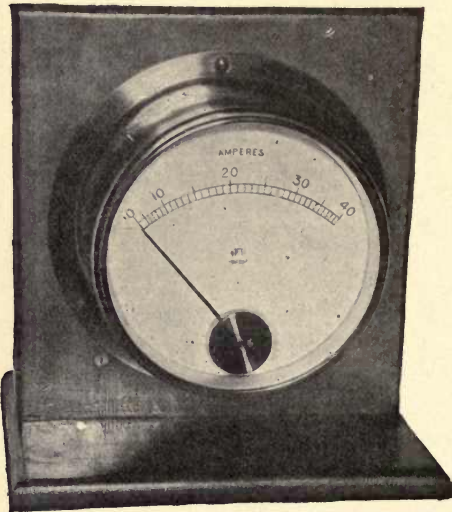

Fig. 30.—Complete Evershed Ammeter on Wooden Stand

In this way the scale can be made to have long divisions throughout any region of the entire range.

This type of Evershed instrument is supplied with or without a "dead-beat" arrangement patented by Mr. Evershed, and shown in figs. 28 and 29 which represent end and side elevations of it. This consists of light aluminium vanes carried and rotated by the spindle *s* which is extended for the purpose. These vanes move in a practically airtight chamber and greatly damp the motion of the

moving spindle, making it almost aperiodic without the introduction of any mechanical friction. Fig. 30 shows a general view of one of these instruments complete, from which it will be seen that a nearly uniform scale graduation is obtained after the first few divisions.

In the instruments intended for use with alternating currents, a separate compensating device is provided for the ammeters and

voltmeters, the object sought to be attained being the same with each, namely, to enable the instrument to be used indiscriminately on alternating and direct-current circuits with the same scale.

In the ammeters, the compensation, which is sufficiently close to the desired result for all practical purposes, is secured by an inductive shunt on the main coil. In the voltmeters, the self-induction of the circuit is neutralized by shunting it with a condenser.

Methods of compensation are, however, considered more in detail on pp. 15-17.

The "N.C.S." Ammeters and Voltmeters

These possess a moving soft-iron needle, have a gravity control, and are made by Messrs. Nalder Bros. and Thompson, of London.

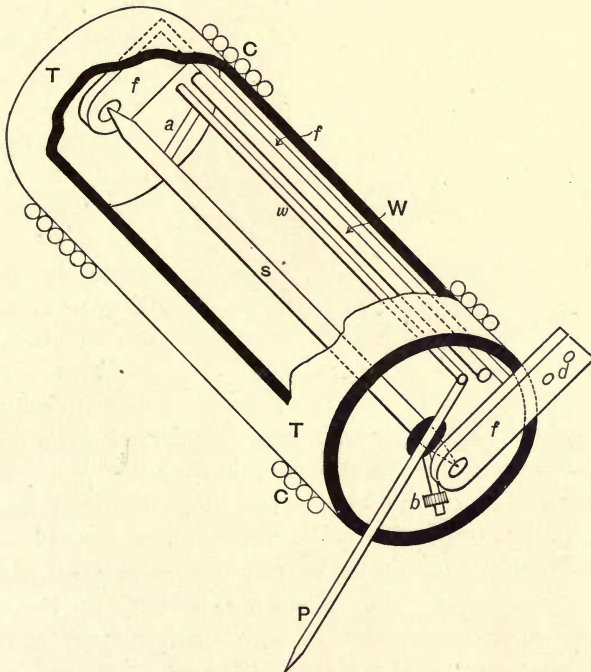

Fig. 31.—Working Principle of "N.C.S." Moving-Needle Instrument

The principle on which they work will be understood from a reference to fig. 31, which shows the principal details in perspective elevation.

The coil or solenoid of wire *c* which is energized by the voltage

or current to be measured is wound on a brass tube *T*, about $1\frac{3}{8}$ inch long and $\frac{7}{8}$ inch external diameter, represented with a portion of its side cut away to show the interior more clearly. Capable of being slipped into and out of *T* is a brass frame *ff*, which carries the jewelled centres in which is pivoted the light steel spindle *s*, concentrically with the tube *T*.

A round soft-iron wire *w*, of a special brand and about No. 8 gauge, is soldered to the under side of the horizontal bar forming part of the frame *f*, and runs nearly the full length of the solenoid.

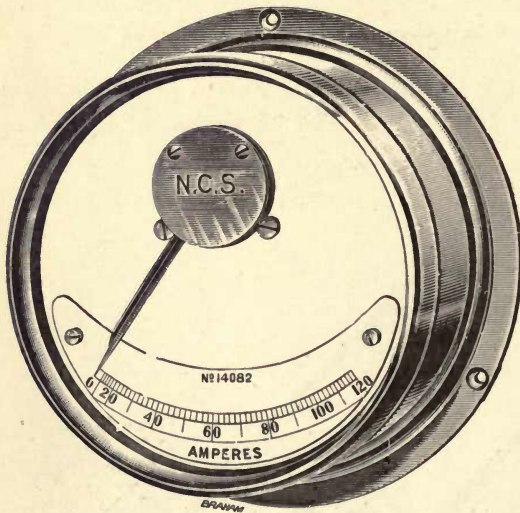

Fig. 32.—General View of "N.C.S." Ammeter

A rather smaller soft-iron wire *w*, of the same special brand, is carried on an arm *a* and an extension of the pointer *P*, by the spindle *s*, which also carries a balance-weight *b*.

The frame *f* is easily removable by unscrewing a couple of screws *d* which fix it to the flange (not shown) of the bobbin on which *c* is wound.

The action of the instrument will now be obvious. When no current passes round *c*, and the pointer *P* is adjusted to zero on the scale (not shown), the moving soft-iron wire *w* is parallel to and almost touching the fixed iron wire *w*, being at the left-hand side of it. When, however, the solenoid is energized by the voltage or current to be measured, *w* and *w* become magnetized, developing similar polarity at the same end. Hence repulsion ensues, and *w* moves away from *w* through a distance depending on the current strength.

In the alternating-current instruments of this make *w* and *w* are made as small as possible, and sometimes laminated to minimize the effects of hysteresis and eddy currents respectively. The bobbin on which the coil *c* is wound should also be slotted to still further reduce the generation of eddy currents in it. For ordinary pur-

poses each instrument is calibrated for the periodicity with which it will have to work, but a special compensating device, comprising a choking coil, can be fitted, which enables the instrument to read correctly with the same scale whether used with direct or alternating currents. Though not supplied with all instruments of this make, an oil damper can be fitted, when desired, to make the motion of the pointer *P* dead-beat.

Figs. 32 and 33 show respectively a complete N.C.S. ammeter and volt-

meter, from which the kind of scale graduations obtained can be clearly seen. The type of scale can, however, be varied to suit the requirements by altering the relative positions of *w* and *w'* for the same zero position of the pointer.

The "edgewise" form of instrument of this make is shown in fig. 34, the only difference other than that of shape being that the motion of the pointer, the end of which is bent at right angles to its stem, is observed in a plane perpendicular to that in which the stem moves. Fig. 35 shows the sector shape or form of the same make with an electric glow-lamp behind the dial for the purpose of illuminating it.

The principal parts and their relative distribution in an N.C.S.

electro-magnetic moving-needle instrument, provided with an oil damping device, is well illustrated in figs. 36 to 38, which respectively represent an end elevation and a sectional side elevation and sectional plan. From a reference to these it will be seen that *f* is

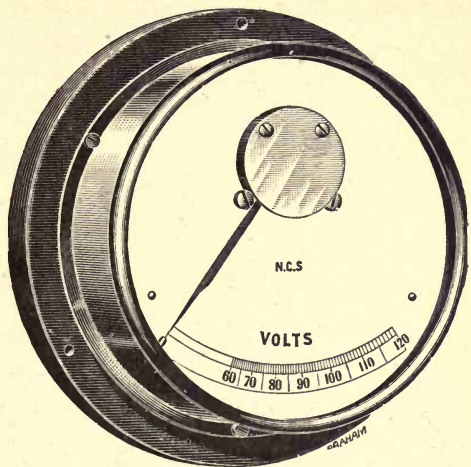

Fig. 33.—General View of "N.C.S." Voltmeter

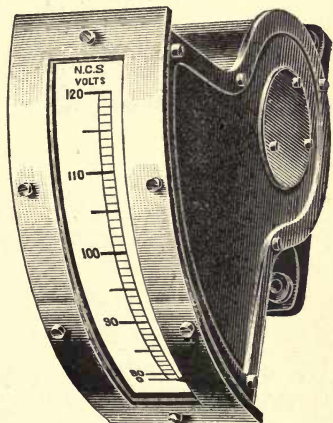

Fig. 34.—"N.C.S." Edgewise Voltmeter

the frame which supports the fixed piece of soft iron *w*, of a special brand, and extending nearly the whole length of the hollow interior of the solenoid.

This latter, in the case of ammeters, is wound to some 400 ampere turns, obtained with a few turns of thick insulated wire; while, in the case of voltmeters, some 200 to 300 ampere turns are employed, obtained with a large number of turns of fine silk-covered

wire having a low temperature coefficient, in order to minimize errors due to variation of temperature.

Carried on a light central steel spindle, which runs in jewelled centres supported by the frame *f*, is the soft-iron wire needle *w*, made of the same special brand of iron and of about the same length as the fixed piece *w*.

The pointer *p*, balance arm, and weight *b* are also fixed to the spindle. The positions of the fixed and moving iron needles in the hollow core of the solenoid, when the pointer is at zero, varies in both ammeters and voltmeters, in order to obtain the requisite scales. In an ammeter, practically an evenly-divided scale from end to

end, having a tenfold range, is obtained, and in a voltmeter a somewhat tapering scale, open at the top and having a twofold range.

As a rule it is only necessary to be able to read the voltage to a small range on either side of the normal working value, and thus the variations are considerably magnified; the current, on the contrary, in the case of an ammeter, should be capable of being read anywhere on the scale.

The damping device used in these N.C.S. instruments of the soft-iron moving-needle type consists (figs. 37 and 38) of a small bath of oil *OP*, fixed as shown at the back of the solenoid, in which swings a light aluminium vane *v* carried by the moving spindle. By this means an almost aperiodic motion of this latter is obtained.

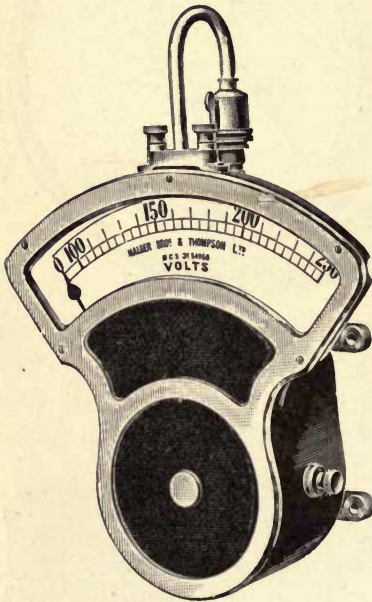

Fig. 35. — "N.C.S." Sector-shaped Voltmeter

The voltmeters of this type and make absorb very little power owing to their high resistance.

In the case of all voltmeters reading above 350 or 400 volts, an

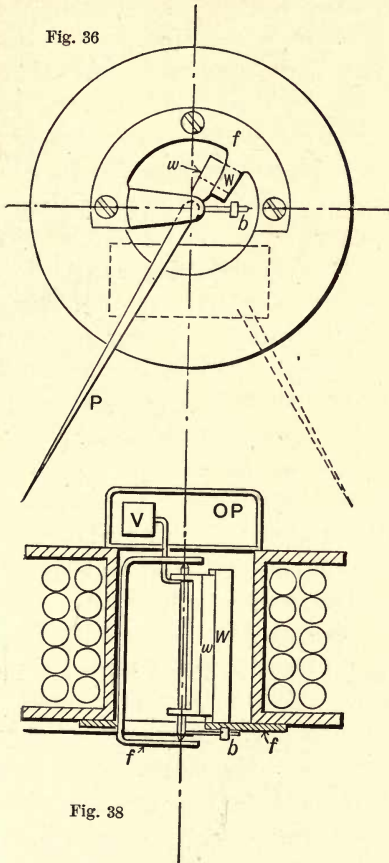

Fig. 38

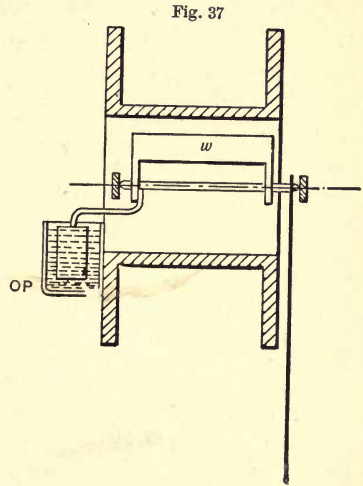

Fig. 36.—End Elevation of Dead-beat "N.C.S." Moving-Needle Instrument

Fig. 37.—Side Elevation of Dead-beat "N.C.S." Moving-Needle Instrument

Fig. 38.—Plan of Dead-beat "N.C.S." Moving-Needle Instrument

extra and separately enclosed resistance is sent with the instrument in order to avoid too many watts being spent inside the instrument, where the amount of radiating surface is necessarily limited. These instruments are designed so as to be capable of standing a considerable overload for short periods without the risk of damaging the winding through overheating.

The Holden, Drake, and Gorham Ammeters and Voltmeters

These instruments possess a moving soft-iron needle, and are provided with a spring control. Their construction is simple, and

will be understood from a reference to fig. 39, which gives a perspective view of the chief parts. *c* is the working coil or solenoid having a soft-iron core *I*, one end of which is flush with the front cheek of the coil. The other end has attached to it a soft-iron angle-piece, the extremity *N* of which, forms the other pole of the electro-magnet *c*. The limb terminating at *N* lies along the outside of *c* as shown. To *I* is fixed a pole piece *s*, and a short spindle *A* is pivoted in jewelled centres between *I* and a brass bracket *B* screwed to the coil flange.

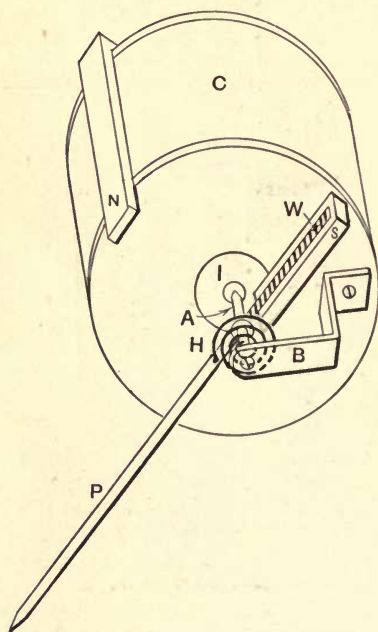

Fig. 39.—Working Principle of Holden, Drake, and Gorham Moving-Needle Instrument

To *I* is fixed a pole piece *s*, and a short spindle *A* is pivoted in jewelled centres between *I* and a brass bracket *B* screwed to the coil flange.

This spindle carries a light pointer of aluminium *P*, a phosphor-bronze hair-spring *H* which controls it, and a soft-iron wire *w*, which, when *P* is at zero on the scale, lies parallel and very close to but not touching *s*.

w is prevented from magnetically sticking to *s* by a distance film of non-magnetic material.

The action is as follows:—When *c* is energized by the current or voltage to be measured, the pole pieces *s* and *N* above referred to, develop, say, south and north polarity respectively. The moving needle *w* is thus inductively magnetized while the current lasts, developing *s* polarity also at its end. Consequently it is repelled from *s* and attracted to *N* against the torsion of the controlling spring *H*, with a force proportional to the current flowing in the working coil *c*.

The deflections of *P* on the scale (not shown) thus indicate the current strength.

The general appearance of a complete instrument of this type and make is shown in fig. 40, from which it will be seen that the scale produced is nearly uniformly divided between about 9 and 70 amperes.

Messrs. Drake and Gorham have recently introduced a slightly different form of instrument belonging to the moving-needle class,

in which the actuating force is due to the attraction and repulsion between two magnetized short semi-cylinders of soft iron.

The construction is similar to the Hartmann and Braun

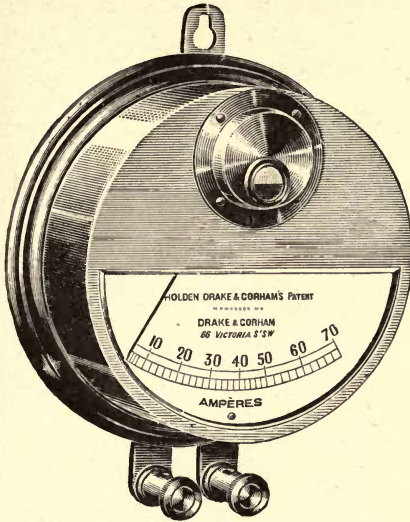

Fig. 40.—Holden, Drake, and Gorham Ammeter

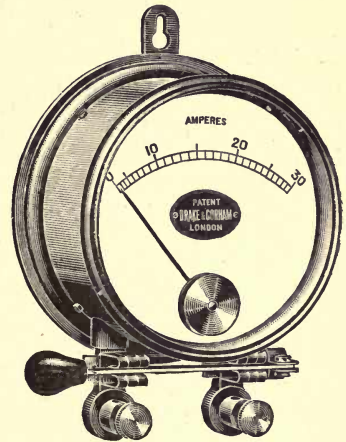

Fig. 41.—Drake and Gorham Ammeter, with Short-circuiting Lever

instruments, p. 51, of this class: the outer half-cylinder is fixed while the inner is movable, being mounted on a light steel spindle to which the pointer is attached.

When this is at zero on the scale, the outer half-cylinder nearly covers the inner one; but when they become magnetized by the solenoid which surrounds them, the inner half-cylinder tends to move, against the controlling force of a spring or gravity, so as to form a complete cylinder. The pointer thus takes up a position on the scale corresponding to the relative position of the moving needle with regard to the fixed one.

To minimize hysteresis errors in the instrument, the amount of iron in the moving and fixed half-cylinders is reduced as much as possible, and it is of the softest quality obtainable.

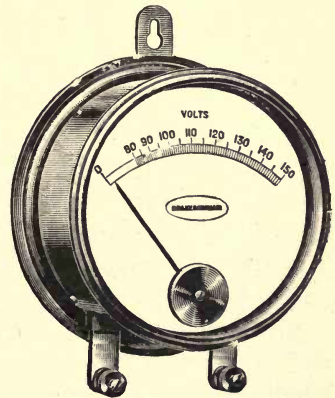

Fig. 42.—Drake and Gorham Voltmeter

Fig. 41 shows a general view of the latest form of a Drake

and Gorham ammeter, having a short-circuiting lever or switch for shunting the current past it, while fig. 42 shows that of a voltmeter from which the kind of scale graduation is at once seen.

The "Dolivo" Ammeters and Voltmeters

These instruments are constructed on the moving soft-iron needle principle, and have a gravity control. Figs. 43 and 44 show the construction and arrangement of the working parts, the former being a side view and the latter a front view.

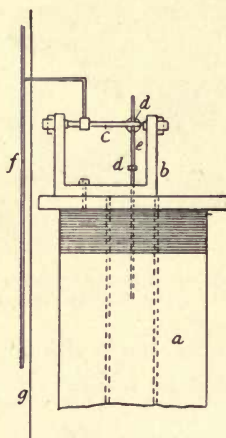

Fig. 43.—Side View of Working Principle of Dolivo Moving-Needle Instrument

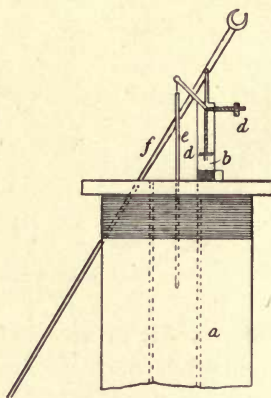

Fig. 44.—Front View of Working Principle of Dolivo Moving-Needle Instrument

Referring to these it will be seen that the instrument consists of a working solenoid or coil *a*, placed with its magnetic axis vertical (the lower portion being shown cut away).

Resting on the top flange of the coil *a*, and screwed to it, is a brass spindle frame *b*, between the standards of which is pivoted a light steel spindle *c* running in jewelled centres. To this spindle is attached the angle-piece carrying the pointer *f* at its extremity, and in addition the moving soft-iron core *e*, which consists of a bundle of fine soft-iron wires, nickel-plated to prevent oxidation. Two balance arms and weights *d* serve as a counterpoise for *f* and *e* respectively. *g* (fig. 43) is the scale over which the pointer *f* moves. The iron needle *e*, being suspended freely from the arm which carries it, is sucked into the coil *a* by an amount depending on the strength of the current or voltage energizing the

coil; and the pointer *f* takes up a position on the scale *g* corresponding to the amount of suction.

The weight on the spindle *c* is small, as the core of fine wires *e* only weighs about 0.04 gram.

According to the length of this core and its position in the coil, any desired type of scale can be obtained, whether nearly uniformly divided throughout, or open only at one particular region.



Fig. 45.—Complete View of Dolivo Voltmeter

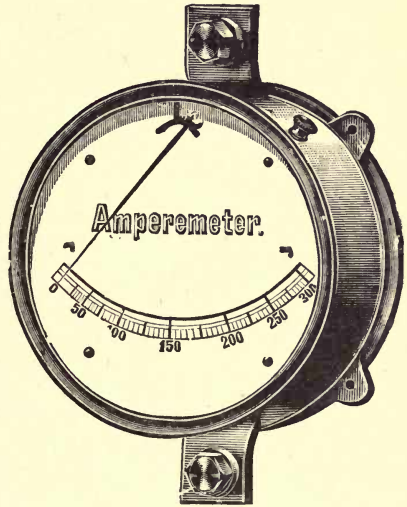

Fig. 46.—Complete View of Dolivo Ammeter

Fig. 45 represents the outward appearance of a voltmeter and fig. 46 of an ammeter of this type.

The “Stanley” Ammeters and Voltmeters

The principle on which these instruments, made by the General Electric Company of London, work, is that of a solenoid actuating a soft-iron needle, having a gravity control. A reference to fig. 47, which is a perspective view of the working parts, will make their construction clear.

A brass frame *F*, fixed to the metal back of the instrument, carries two soft-iron blocks *B*, which are arranged with a gap between them.

Pivoted in jewelled centres, which are carried by the back of the frame *F* and a separate discoidal bracket *D* in front, is a light steel spindle *s*. To the front end of *s* is fixed the light aluminium

pointer P and balance-weight A, and to the centre region a light soft-iron sector-shaped needle or plate N, capable of moving in the gap between BB. The discoidal bracket D is carried by a flange C screwed to the metal dial of the instrument, and is really quite separate from the frame F. The whole frame F, with its attachments, slips into the working coil or solenoid (not shown in fig. 47), which is energized by the current or voltage to be measured.

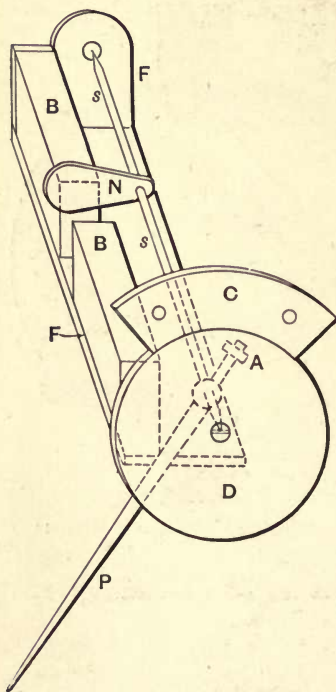

Fig. 47.—Working Principle of Stanley Moving-Needle Instrument

The action is simple, and is as follows:—The solenoid, when energized, magnetizes the soft-iron blocks B, and produces a strong magnetic field across the air-gap separating them. Into this field, and therefore into the gap, the sector N is attracted by an amount depending on the current flowing in the solenoid. The pointer P thus takes up a corresponding position on the scale.

The iron used in the instrument is the best soft iron obtainable, and is carefully annealed, and so formed as to reduce the hysteresis error to a minimum.

Fig. 48 shows the general form of a voltmeter of this make; and, as seen from the figure, in this particular instrument, the graduations from 60 to 120 volts occupy almost the whole scale, though by varying the relative

positions of N and BB when the pointer is at zero, almost any kind of scale can be produced.

Fig. 49 shows a back view of the voltmeter with polished gun-metal case removed. The hollow solenoid is shown at the top, and is wound with a large number of turns of fine insulated copper wire, which, however, only forms a small part of the total resistance of the voltmeter, the rest being wound separately on two china bobbins of the form seen under the solenoid. This has the advantage of high insulation and large radiating or coiling surface for the wire. An ammeter of this make is shown in fig. 50, and in

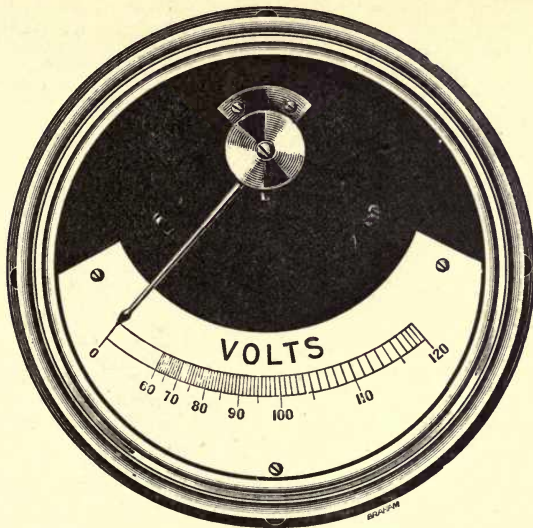

Fig 48.—Stanley Voltmeter]

this case, of course, the solenoid is wound with a few turns of thick wire, to carry the main current to be measured. It will be observed that the scale opens out slightly towards the higher readings.

These instruments are also made with a spring control instead of a gravity control, in which case the moving parts are accurately balanced on the spindle, so as to render the indications independent of the position in which they are placed.

They can also be provided internally with the M'Whirter patent magnetic shield, to protect the working parts from stray external fields due to any cause, such as neighbouring dynamos or mains carrying current, &c.

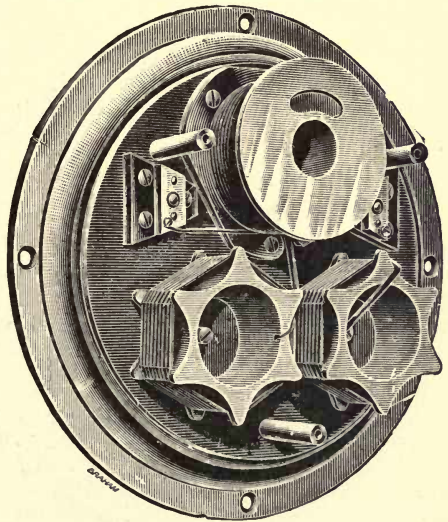

Fig 49.—View of Interior of Stanley Voltmeter (case and scale removed)

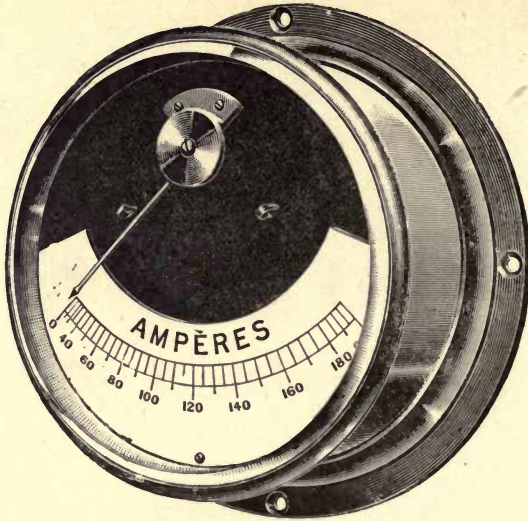

Fig. 50.—Stanley Ammeter

The General Electric Company also make a permanent-magnet control type of electro-magnetic ammeter and voltmeter, the principle of which is

that described on pp. 54 to 56. The general form of the instrument is seen in fig. 51. The scale is shorter than the type just considered, owing to it being graduated on each side of a central zero. There is, however, no error due to residual magnetism, and the fact that this kind of instrument can deflect either way is often useful; as, for instance, in storage-

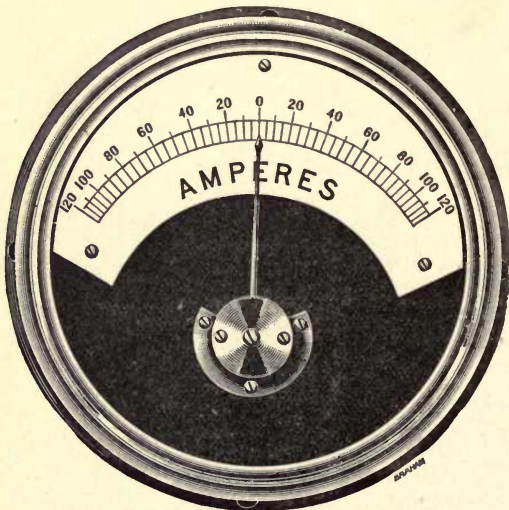

Fig. 51.—Stanley Ammeter, with Zero in centre of Scale

battery circuits, to show the charge and discharge currents. Literally this is an instrument having a polarized needle, and

the direction in which it is deflected depends on which way the current flows round the main solenoid energized by the current, or voltage, to be measured. ✓

Miller's Electro-Magnetic Ammeters and Voltmeters

These instruments are of the moving-needle type, having a gravity control. The only difference between ammeters and voltmeters of this type lies in the winding of the solenoidal coil, which is wound with thick wire for the former and fine wire in the case of the latter.

A perspective view of the working part is shown in fig. 52. A soft-iron wire *N*, about No. 22 B.W.G., is carried by a horizontal spindle *s*, pivoted in jewelled centres which are supported by the frame *F*.

The pointer *P* is also rigidly attached to the spindle *s*, and a

balance-weight *b*, attached to the boss which carries the needle *N*, enables the centre of gravity of the moving system to be adjusted so that the pointer *P* rests at some convenient part of the scale. *C* is the working solenoid, having a narrow rectangular aperture through its centre in which *N* can move freely.

The spindle frame *F* is screwed to the top flange *A* of *C* in such a position that *N* can take up a position parallel to the magnetic axis of the solenoid, but to one end of the rectangular aperture. The frame *F* overhangs the front side of the coil *C*, so as to allow of the free motion of *P* over the scale (not shown in fig. 52).

The action of the instrument will be obvious. When a current flows through *C*, this coil develops opposite polarity at its ends, causing the soft-iron needle *N* to become magnetized, thereby sucking its free or outer end down into the solenoid to an extent depending on the current flowing through *C*. The pointer conse-

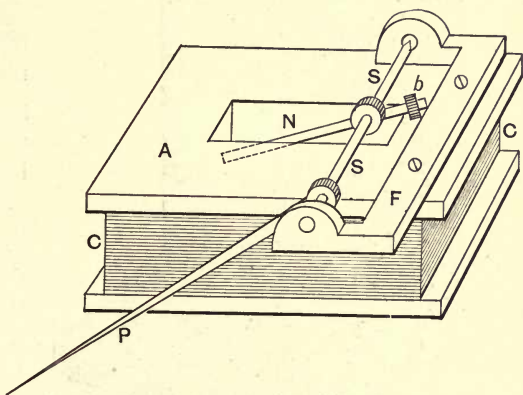

Fig. 52.—Working Principle of the Miller Moving-Needle Instrument

quently takes up a position on the scale corresponding to that of N in the solenoid. In the zero position of P , *i.e.* for no current, N lies nearly at right angles to the coil axis; and its final position for maximum deflection is parallel to the magnetic axis of C . Thus P moves over a graduated scale which forms nearly a quadrant of a circle.



Fig. 53.—Miller Voltmeter

Fig. 53 shows the general view of a complete instrument of this type.

While it has already been stated that instruments of this class are generally subject to errors due to hysteresis in the iron-needle part, such errors can be minimized by using only the softest iron obtainable, and as little of it as will enable the instrument to work.

In addition to these essentials, such an instrument, intended for measuring alternating current

or voltage, must be calibrated at the same periodicity as that of the circuit for which it is intended, otherwise the readings will not be correct.

Hartmann & Braun's Ammeters and Voltmeters (Electro-Magnetic Type)

These instruments, supplied by Messrs. O. Berend & Co., belong to the "moving-needle" class of ammeters and voltmeters, in which the electro-magnetic attraction and repulsion of a moving soft-iron needle by a fixed solenoid is made to indicate the current or voltage to be measured. They have a gravity control, and, as in the case of all instruments of this class, can be used not only for continuous but also for alternating currents, with slight modifications in the latter case.

The principle on which they work, and their construction, is shown in perspective in fig. 54. A solenoid or coil *c* of insulated copper wire, consisting of a few turns of thick wire in the case of ammeters and many turns of fine wire in that of voltmeters, is wound on a bobbin about $1\frac{1}{2}$ inch long and about $\frac{3}{4}$ inch internal bore. Capable of being inserted and fixed inside this is a thin brass tube *T*, in the middle region and on the outside of which is wrapped and fixed a tapered strip of soft iron *w*, about $\frac{1}{8}$ inch

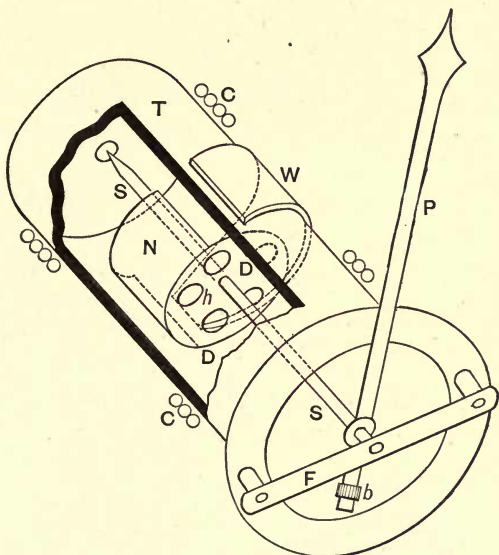

Fig. 54.—Working Principle of the Hartmann and Braun Moving-Needle Instruments

thick, and extending not quite half-way round *T*, and tapering from $\frac{7}{8}$ inch wide at the top to about $\frac{3}{8}$ at the under side.

Mounted on a steel spindle *s*, running in jewelled centres concentric with *T*, is a thin brass disc *D*, about $\frac{9}{16}$ inch diameter, perforated with about five holes *h* to lighten it. This disc *D* carries a thin semi-cylindrical band of soft iron *N*, about $\frac{3}{8}$ inch wide, which we may term the moving needle. The spindle *s*, which also carries the pointer *P* at one end, and a balance-weight *b* at the other, runs in the jewelled centres fixed respectively in the back end of the tube *T* and the cross-bar *F* in front.

The action will now be tolerably obvious.

In the zero position of the pointer *P*, the needle *N* partly overlaps the lower half of *w*; and when a current flows in the

solenoid C, N turns so as to try to form a whole cylinder with w, the amount of turning depending, of course, on the current strength. The

tapering of w ensures a more definite and sensitive action of N, and the relative positions of P and N on s enables the scale to be made open at any part of the range of the instrument. In fig. 54 the tube T is cut away to show the interior and working parts more clearly. A general view of a complete instrument (ammeter) is shown in fig. 55, and it will be seen that the readings commence at about 10 per cent of the maximum.

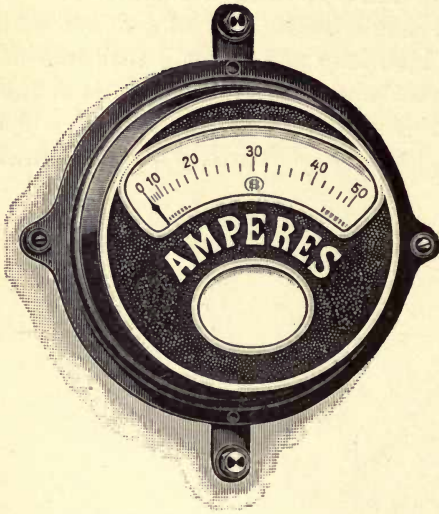

Fig. 55.—Hartmann and Braun Ammeter

Fig. 56 shows the general view of a voltmeter having an "open scale" from 90 to 130 volts.

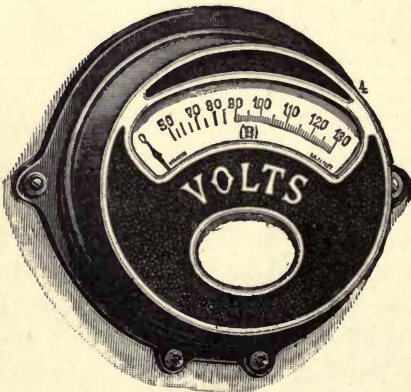

Fig. 56.—Hartmann and Braun Voltmeter

For voltages of and above 400, an extra resistance, contained in a separate case, is provided for placing in series with the instrument. For alternating-current work the amount of iron contained in w and N is reduced to a minimum, and each instrument is calibrated for the periodicity of the circuit on which it is intended to be used, and this periodicity is marked on it. An iron case

is used in these instruments to minimize any effect on the readings due to the close proximity of neighbouring magnetic fields.

The Schuckert Ammeters and Voltmeters

These instruments possess a moving soft-iron needle having a gravity control, and are made by Messrs. Schuckert & Co., of Nürnberg.

The moving system by itself is shown in fig. 57. It consists of a thin piece of the softest sheet-iron *a d*, or of ferrotype, bent and shaped as in figure. This is carried by a light horizontal spindle

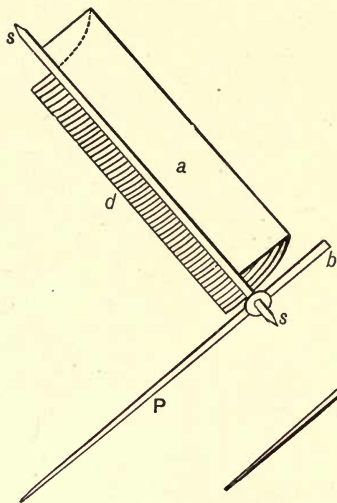

Fig. 57.—Moving System of Schuckert Instrument

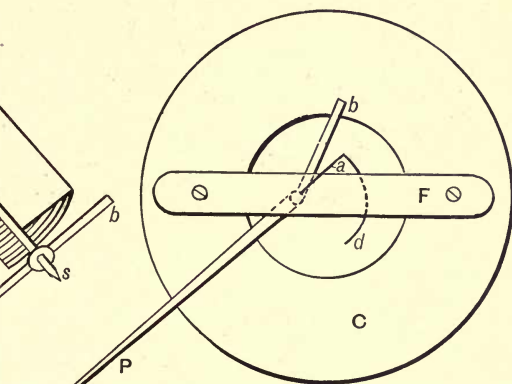

Fig. 58.—Arrangement of Moving Needle inside Solenoid of Schuckert Instrument

s running in jewelled centres, to which is also attached the light aluminium pointer *P* and balance arm of copper *b*. As will be observed, the part *a* of the moving plate or iron needle is flat, but the remaining portion *d* is curved.

Fig. 58 shows the position of the moving needle in the actuating coil or solenoid *c*, which is of the same length as the needle. It will be noticed that the spindle is pivoted eccentrically with the centre of the coil, a little to the left of it, but is parallel to the coil axis. Now the magnetic field inside a solenoid such as this is by no means uniform over the cross section, being strongest at the centre of its axis, p. 9. At the ends, however, the field is strongest at the inner edges of the coil, owing to the lines of force leaking out there.

Hence, when a current flows round the coil *c*, the needle is

sucked up in such a way that the curved part becomes closer and more parallel to the inner periphery of the coils. The pointer *P*, therefore, takes up a position on the scale depending on the strength of the voltage or current which has energized *c*. Friction

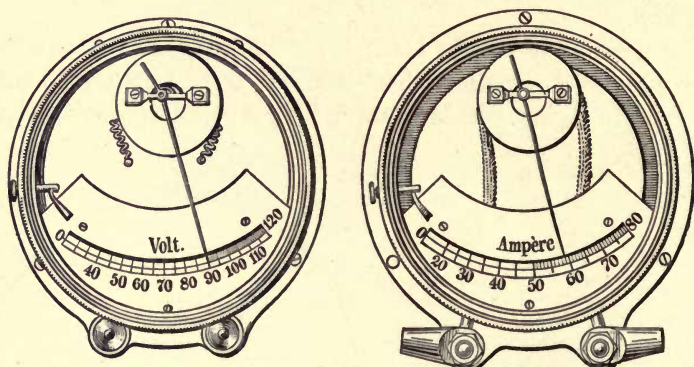

Fig. 59.—Schuckert Voltmeter and Ammeter

at the pivots is reduced to a minimum, owing to the extreme lightness of the moving parts.

Fig. 59 shows the general views of a voltmeter and ammeter respectively, finished instruments; and it will be observed that the divisions are not uniform throughout the scale. The scale can be made “open” at any part of the range by bending the balance arm *b*, or by altering the distance of the centre of the pivot from that of the coil.

The “Castle” Ammeters and Voltmeters

These belong to the electro-magnetic moving-needle class of measuring instrument, and present the somewhat uncommon feature of possessing a “magnetic” control, in which neither spring nor gravity is employed.

Fig. 60 is a perspective view, showing the principle on which they work. *M* is a permanent steel horse-shoe magnet, the poles of which carry two soft-iron rods *R* in alignment horizontally. The ends of these, facing one another, form the poles *N* and *S* of a strong horizontal magnetic field, in which is pivoted, on a spindle *a* running in jewelled centres, a diamond-shaped piece of soft iron *N'S'*. This soft-iron needle is held in a horizontal position by the fixed field due to *M*.

The deflecting field is produced by two solenoidal coils c , having iron cores which approach $N'S'$, and which are energized by the current or voltage to be measured. Their magnetic axes are vertical, and they develop opposite polarity ns as shown. A pointer P is, of course, rigidly attached to a , and is balanced by an extension b .

The action is as follows:—For no current passing through cc , the needle $N'S'$ is magnetized inductively, as indicated, by the permanent field-poles NS , and is held in the position shown, the pointer P being then at zero on the scale.

When, however, cc are energized by the voltage or current to be measured, and develop polarity, as shown, the south pole s of the upper coil c repels the south pole s' of the needle and attracts its north pole N' , whereas n attracts s' and repels N' . Thus the two effects are added together, producing a couple which cause $S'N'$ to turn in a counter-clock-wise direction through a certain angle depending on the magnetic strength of cc .

The pointer P , therefore, takes up a corresponding position on the scale. This may be otherwise stated in more scientific language as follows. The two magnetic fields NS and ns at right angles to each other set up a resultant magnetic field which turns counter-clock-wise through an angle nearly proportional to the field strengths of cc . Along this resultant the soft-iron needle $S'N'$ sets itself.

In the case of ammeters, cc are wound with thick wire and carry the main current, but in voltmeters they are wound with a large number of turns of fine copper wire having a large resistance.

The adjustment of the instruments to give any desired scale, open at any part of the range, is made by altering the position of

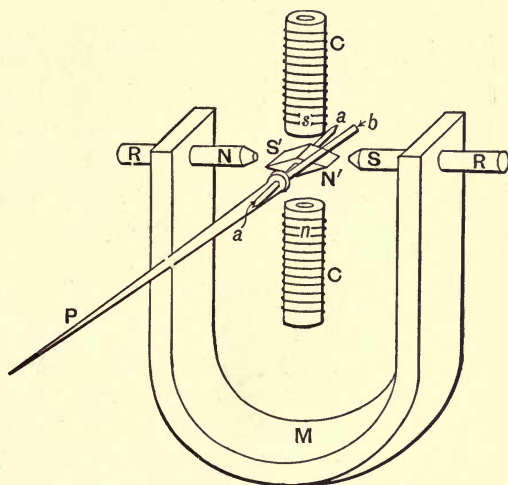

Fig. 60.—Working Principle of "Castle" Moving-Needle Instrument

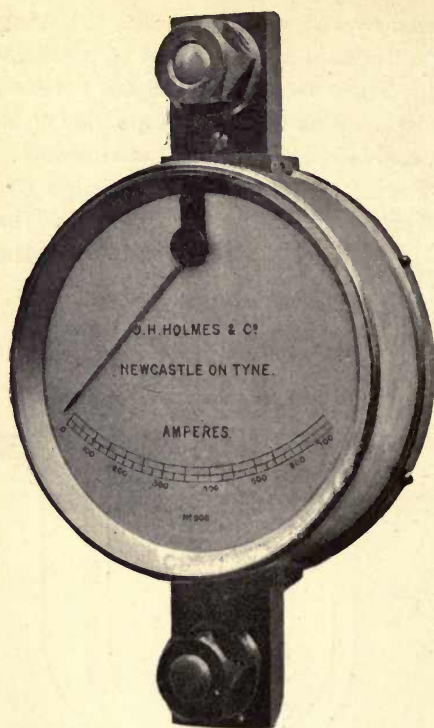

Fig. 61.—“Castle” Ammeter

of London, and are also called the “station” type ammeters and voltmeters. As is the case with instruments of this class, by a

the vertical coils *CC* and the horizontal pole pieces *NS* relatively to the central soft-iron needle.

Fig. 61 illustrates a complete instrument of this type, from which it will be noticed that the scale is almost uniformly divided. These ammeters and voltmeters are supplied by Messrs. J. H. Holmes & Co., of Newcastle-on-Tyne.

The “Victory” Ammeters and Voltmeters

The principle on which these instruments work is that of a hollow solenoid actuating a moving soft-iron needle, having a spring control. They are supplied by Messrs. H. M. Salmony & Co.,

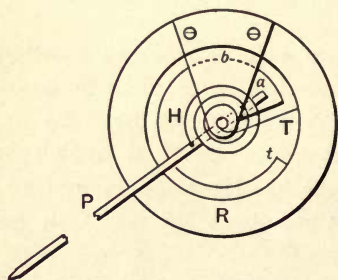

Fig. 62.—End Elevation of Working Principle of Direct-Current Victory Instruments

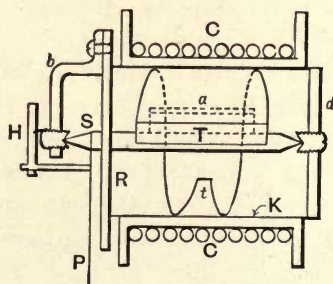

Fig. 63.—Side Elevation of Working Principle of Direct-Current Victory Instruments

slight structural modification they can be adapted to measure alternating current and voltage, in addition to continuous current.

The principle on which they are constructed will be understood by reference to fig. 62, which is an end elevation, and fig. 63, a sectional side elevation of the working parts of a direct-current ammeter or voltmeter.

c (fig. 63) is the main actuating coil or solenoid about $1\frac{1}{4}$ inch long, wound with insulated copper wire or tape on a hollow brass tube about $\frac{3}{4}$ inch diameter. Capable of sliding tightly into this is another thin tube *K*, carrying a ring disc *R* at the front end, but

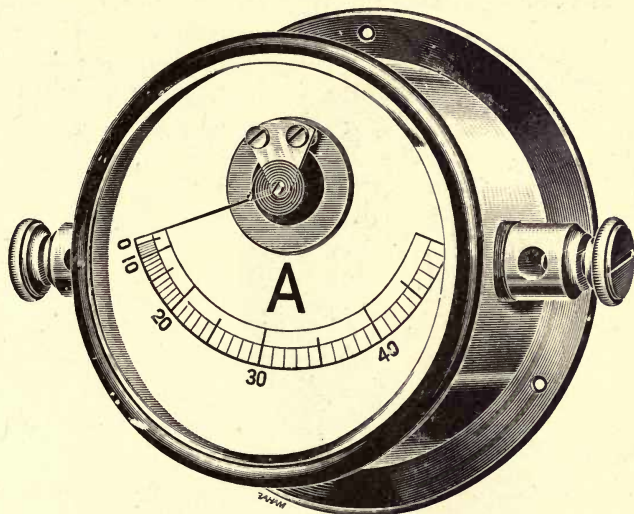

Fig. 64.—“Victory” Ammeter

closed by a disc *d* at the back. A thin strip of the softest sheet-iron is bent so as to form a radial plate *T* about $1\frac{1}{4}$ inch long (axially) and then bent round close to the inside surface of the tube *K*, but tapering down to about $\frac{1}{8}$ inch at the end *t*, and not quite completing the circle.

The moving system consists of a thin strip or plate of soft iron *a*, about as long, axially, as *T*, and carried by the steel spindle *s*, which runs in jewelled centres let into *d* and the bracket *b* concentrically with *c*. The pointer *P* is also rigidly attached to *s*, and the whole moving system is controlled by a fine hair-spring *H* of phosphor-bronze. In the zero position of *P* on the scale (not shown), the moving plate *a* is close and nearly parallel to the fixed one *T*.

The action will now be obvious. When a current passes round

the solenoid *c*, it magnetizes both *a* and *T* and repulsion ensues, owing to like polarity being induced in *a* and *T* at the same end.

Since at the commencement *a* and *T* are close together, and also of about the same length, a comparatively small current gives a relatively large effect or displacement of *a*, and therefore deflection on the scale. Owing, however, to the tapering of the fixed strip, the distance between its poles gradually diminishes as we get round to *t*, hence their distance from the moving poles of *a* also dimin-

ishes. The result is that after the first few divisions on the scale have been passed over, the deflecting force becomes nearly proportional to the angle of deflection. But the force of control of *H* is also proportional to this angle, therefore the result is nearly a uniformly graduated scale. The distance between *a* and *T* at starting determines the openness of the scale here to a large extent.

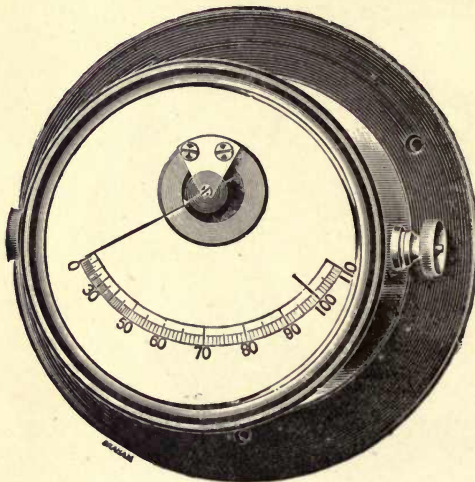

Fig. 65.—“Victory” Voltmeter

The iron of both *a* and *T* is the softest obtainable, in order to diminish to a minimum errors due to hysteresis.

Fig. 64 shows the general view of such an ammeter and fig. 65 of a voltmeter, both with front terminals. Back terminals are, however, employed for switch-board work. The advantage of the spring control is that the pointer does not require to be set to zero before switching on the current, and the instrument can be used in any position.

For alternating-current measurement the instrument is slightly modified, figs. 66 and 67 showing the arrangement. Here a fixed soft-iron wire *w*, about No. 16 or No. 14 gauge, is placed between the coils *c* and the tube *K*, and extends the length of the solenoid, which is about $1\frac{1}{2}$ inch long. A soft-iron wire *w*, about No. 16, is carried by the spindle, which is now pivoted eccentrically with the

axis of the solenoid, the two centres being carried respectively by the cross-bar *N* at the back and the bracket *b* at the front.

The moving needle or wire *w* is close up to and parallel with the fixed wire *w*, when the pointer *P* is at zero. Consequently when a current flows in *c*, similar polarity is induced in *w* and *w* at the same end, and repulsion ensues. The motion is controlled by a hair-spring *H* of non-magnetic material such as phosphor-bronze. From the above description it will be observed that the amount of iron employed in the construction is reduced to a minimum, and is

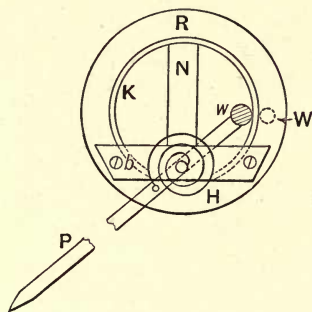

Fig. 66.—End Elevation of Working Principle of Alternating-Current "Victory" Instruments

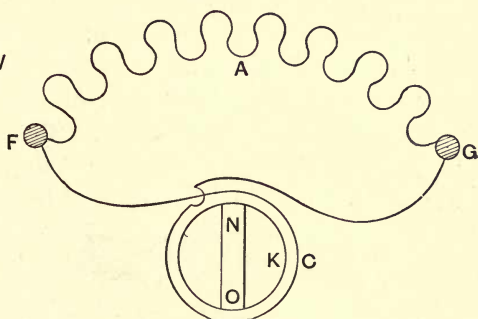

Fig. 67.—Diagrammatic Principle of Alternating-Current "Victory" Instruments

much less than in the instrument made for direct currents. The scale is long and open, and after the first few divisions is nearly uniformly divided.

Referring to fig. 67 it will be seen that the solenoidal coil *c*, connected to the terminals *F* and *G* of the instrument, is shunted by a low-resistance strip *A* of low temperature coefficient material, which carries most of the current. This strip, which is shown on edge, is made with about the same number of, nearly circular, loops as there are turns of wire in *c*. This tends to make the self-induction of *c* and *A* more nearly equal, and therefore to minimize error introduced from this cause. As, however, the instruments contain iron in their construction, they must be calibrated at the periodicity for which they are intended to be used.

CHAPTER III

MOVING-COIL ELECTRO-MAGNETIC INSTRUMENTS

Ayrton and Mather's Astatic Voltmeter

This voltmeter works on the principle of the D'Arsonval Galvanometer, and is therefore applicable for direct pressures only. It, however, possesses a gravity control instead of the usual springs employed for that purpose.

The moving system consists of three coils side by side, each of which, when the current flows through the three of them in series, is acted on by, and attracted into, the poles of a separate permanent magnet.

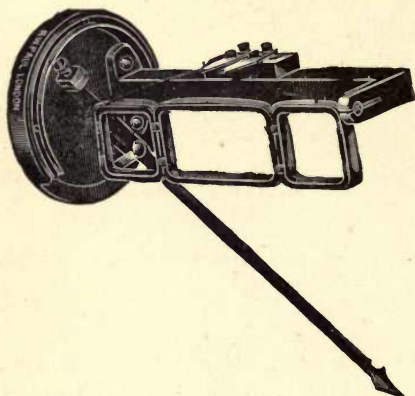

Fig. 68.—View of Moving Coil and Pointer of Ayrton and Mather Astatic Voltmeter

The coils are wound on copper frames in which, as the coil moves, Foucault currents are induced which damp the motion and render the instrument dead-beat. The gravity control acts on the coil itself, which is pivoted in jewelled centres, and carries the pointer fixed to the coil.

The ends of this moving coil are connected through fine flexible wires to the terminal blocks seen at the top of the supporting bracket arm, and through which the current enters and leaves the coil. Fig. 68 indicates the disc which carries the bracket on which the coil and pointer is pivoted.

The fixed-magnet system is also shown in fig. 69, and consists of three astatically-arranged permanent steel ring-shaped magnets.

These are very large, powerfully magnetized, and aged to prevent decay of magnetism. They are mounted on a strong brass spider casting, the centre magnet being larger than the others

and having its poles in the reverse direction. Fixed to the steel magnets are specially-shaped soft-iron pole-pieces, designed so as to produce an open scale at or about the normal working pressure. The resistance of the whole instrument averages about 60 ohms per volt, while that of the moving coil, which is wound with fine insulated copper wire, is about one-twentieth of that of the whole instrument.

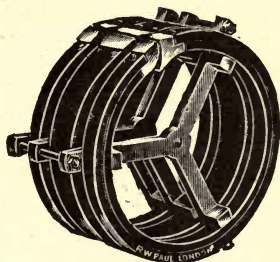

Fig. 69.—Astatically Arranged Permanent Magnets



Fig. 70.—Ayrton and Mather's Moving-Coil Astatic Voltmeter

The extra resistance is of manganin wound into a coil and placed inside the instrument.

The temperature error under these circumstances is quite inappreciable.

The readings of this astatic central-station voltmeter are quite unaffected by external magnetic fields however situated, and all the working parts are highly insulated from the case.

An index pointer, actuated by a crown wheel and pinion, which can be turned by a milled ebonite head at the top of the case, can be set to the working pressure of the circuit.

Fig. 70 shows the general appearance of this instrument with the index pointer set to 102 and the pointer clamped at zero.

Siemens' Electro-Dynamometer

This is undoubtedly one of the most important of current-measuring instruments, since it is capable of measuring indiscriminately either direct or alternating current equally accurately with one and the same calibration, no matter with which kind of current this last-named is effected. Further, as there is no iron in its construction, it is entirely independent of the periodicity and "wave form" of the current to be measured.

The principle on which the instrument works depends, as its name implies, on the electro-dynamical action of one circuit carrying a current on another circuit carrying the same current; in other words, on the mutual attraction and repulsion between adjacent circuits carrying the same current. Its construction will be understood from a reference to fig. 71, which shows the working parts of the dynamometer symbolically, and to fig. 72, which is a general view of the instrument, correspondingly lettered.

As shown in fig. 72 it consists of a wooden base-board, supported on three levelling-screws and carrying two stout wooden standards, to which are attached all the fittings.

These latter comprise two totally distinct and separate stationary coils, F and f , of double cotton-covered copper wire, wound one over the other. They are fixed to the upright standards by a non-metallic band cleat (shown passing across them in front, fig. 72), with their magnetic axes horizontal.

These fixed coils are usually wound with two different gauges of wire, there being a few turns of the thicker wire outside, and a much larger number of turns of the thinner wire inside, connected respectively between the terminal T_1 and common junction-block R , and between R and T_2 . This enables a wider range of sensitiveness

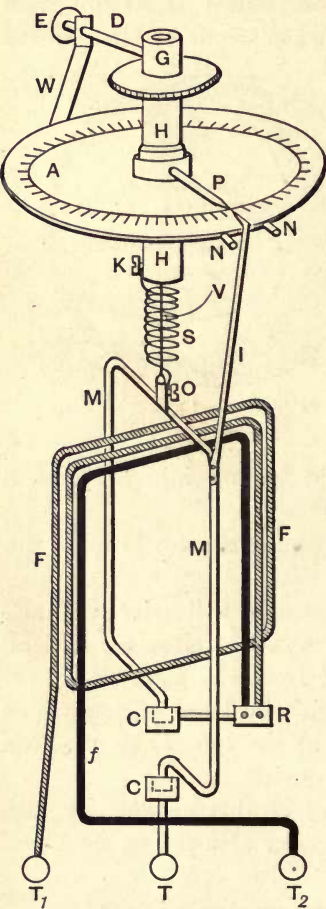

Fig. 71.—Working Principle of Siemens' Electro-Dynamometer

and measurement to be obtained than would be possible with only one fixed coil. The actual windings for a 0–20 and 20–60 ampere dynamometer are also clearly shown in fig. 72, the former range being obtained with the thinner and the latter range with the thicker coil of five turns shown in fig. 72.

Encircling these fixed coils is a moving coil M , which may

consist of one or more turns of copper wire of the same gauge as F, suspended by means of a strong silk thread v from the end of the rod D, which projects inside the loose bush G.

The ends of the moving coil M dip into two mercury cups c c, directly in a line under the point of suspension, by means of which the current is led into and out of M. The top cup c is permanently connected to R, and the bottom cup c to the centre or common terminal T.

To the moving coil M is attached an index pointer I, which plays between two stops or pins N N let into the edge of the circular scale A fixed to the top of the wooden standards. Matters are so arranged that when the index I is opposite zero on the scale A, the plane, and therefore the magnetic axis of M, is at right angles to F and f; this may be termed the "zero position" of M.

The moving coil is controlled by a rather long helical steel or phosphor-bronze spring S, one end of which is attached to the set-screw O, and the other to set-screw K on the lower end of the hollow rod H of the torsion head.

This latter passes up through the fixed scale A, and can be turned through one revolution by the milled head at the top of the instrument. The pointer P, fixed to H, moves round the scale A through one turn also. A loose hollow bush G is let into the top of H, so that when the spindle D, which passes through the fixed bracket W and into G, is turned by the milled head E, the suspension v is wound or unwound on the end of D, inside G, thereby raising or lowering the moving coil M. The dynamometer

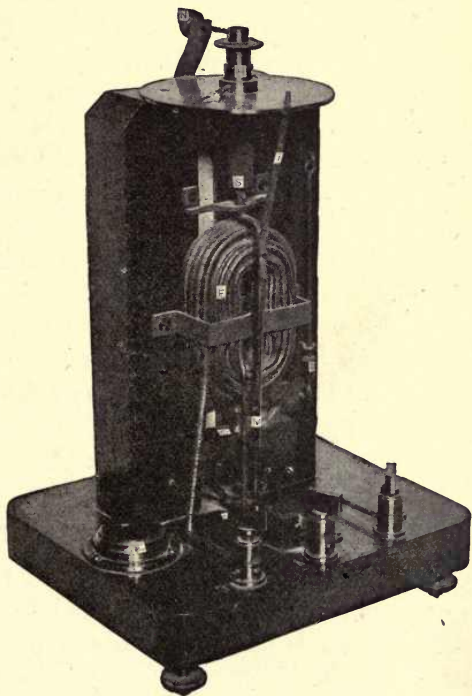

Fig. 72.—General View of Siemens' Electro-Dynamometer

has to be carefully levelled before using it, so as to ensure perfect freedom of the moving coil both in the mercury cups *c* and other fixed fittings. For this object the three levelling-screws on which the base rests, together with the spirit-level *L* and plumb-bob *B* (fig. 72), are added, though sometimes only *B* is provided.

The instrument is a zero one. At the actual moment of measuring a current by it the fixed and moving coils are always in the same relative position; that is, they have their planes perpendicular to one another, and the index *I* is at zero.

When a current c_1 flows through the dynamometer the moving coil is deflected and the index *I* moves counter-clockwise up against the right-hand stop *N*. The force of attraction or repulsion exerted between the fixed and moving coils is $F \propto c_1 \times c_1 \propto c_1^2$, since each coil carries the same current c_1 .

The torsion head *H* is now turned clockwise, which twists round the upper end of the spring *s*, attached to *H*, until *I* floats at zero again. Then, since the force exerted between the coils is now just balanced by the force of torsion exerted by the spring *s*, which latter is \propto to the angle of torsion or deflection *D* of the head *H* and its attached pointer *P*, we have

$$\begin{aligned} D &\propto c_1^2, \\ \text{or} \quad c_1 &\propto \sqrt{D}. \\ \text{Hence} \quad c_1 &= \kappa \sqrt{D} \text{ amperes,} \end{aligned}$$

where κ is the constant of calibration for the particular fixed coil in use, and converts the deflections into equivalent amperes.

The last relation is the *Law of the Siemens' Electro-dynamometer*.

Referring to fig. 71 it will be evident that when the current is reversed in, say, the moving coil, it also simultaneously reverses in the fixed one, the deflection of *I* and *P* being therefore unaffected.

Hence the instrument will work equally well with alternating currents of any periodicity, and this is one of its most valuable properties.

In some cases the fixed scale *A* is degree-divided, but any other suitable graduation may be used, such as one of 400 equal divisions, or one in which the numbers are proportional to the square roots of these divisions. In this latter case

$$c = \kappa D \text{ simply,}$$

where *D* = the deflection of *P* on *A*.

When employing the instrument with direct currents it should be placed so that the magnetic axis of the moving coil lies in the magnetic meridian of the earth. This would be its position of rest when acted on by the earth's field, which it would be in addition to that of the fixed coils.

The instrument possesses the following advantages:—

(1) That it is capable of measuring alternating and direct currents equally accurately, and is quite independent of the periodicity of the former owing to the absence of iron in its construction.

(2) That it can be calibrated with direct currents though intended to be used for alternating ones.

(3) That it is a zero instrument and possesses a constant K , so that the whole scale can be calibrated by two or three readings. In practice, however, it will be found that K is not truly constant from end to end of the scale owing to irregularities in the action of the spring s , and that the employment of a calibration curve is desirable for accurate work.

The disadvantages are—

(1) That it is not portable because of the use of mercury cups.

(2) That it is not direct-reading, and therefore is difficult to read on a circuit in which the current is at all fluctuating.

(3) That it is affected by external magnetic fields, and for this reason the "leading in and out" leads should either be run very close together or twisted so that the currents in them may not affect the readings of the instrument.

Torsional Moving-Magnet Voltmeter

It is frequently the case in experimental work in the electrical laboratory that an instrument with a long and open scale is required, or is, at least, desirable.

Such an instrument, having a long range in addition to a wide open scale, is shown in fig. 73, which merely indicates the chief details of construction, without showing the fixings that support the various parts.

The instrument is chiefly used as a voltmeter, but it can also be employed as an ammeter to measure very small currents. In principle it is magnetically and electrically the converse of the so-called permanent-magnet moving-coil instruments, since the coil or coils are fixed while the permanent steel magnet is movable.

Referring to fig. 73 the voltmeter consists of two elongated rectangular bobbins wound with coils S N , S N , of fine insulated copper wire, and fixed a short distance apart with their longest sides vertical, and with their magnetic axes collinear and horizontal. They are so connected together in series between the fixed terminals T T , that opposing faces are of opposite polarity N . and S . Sus-

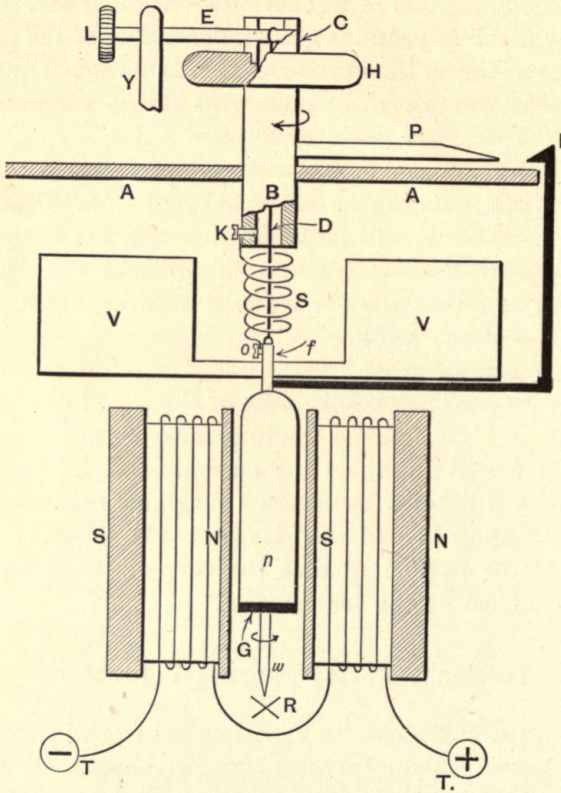

Fig. 73.—Principle of Siemens' Torsional Moving-Magnet Voltmeter

ended midway between these two coils is a small permanent U-shaped magnet, of which only the north pole n is visible. This magnet has rather long straight limbs which are close together and hang vertically, the south pole being consequently behind the north pole n , and therefore invisible in fig. 73.

Into the top, *i.e.* the yoke, of this magnet is fixed a pin f with a small set-screw o in it. A silk thread or cord D is attached to the end of f , and passes up through a hollow rod B . and is fixed to a rod E .

An index pointer *I* is fixed to *f*, and its play is limited between two fixed pins let into the edge of the fixed-scale plate *AA*. When *I* is in the midway or zero position between these stops, the magnetic axis of the suspended magnet is at right angles, approximately, to that of the fixed coils. Two aluminium vanes *vv* are also rigidly attached to *f*, each moving between two fixed brass plates or cheeks, which not only limit the angular motion of the magnet, but also damp its motion to some extent.

One end of a helical steel spring *s* is clamped under the set-screw *o*, and the other under the screw *K* in the end of the rod *B*, which is provided with the milled head *H*.

A small hollow brass boss *C* is let into *H*, so that *H* can turn without *C* turning, and this boss forms a bearing in which the rod *E* can turn. *E* passes through the fixed standard *Y*, and has a milled head *L* at the end. A pointer *P* is fixed to the torsion head *B*, and moves over the horizontal scale of degrees or any other divisions *AA*. A light brass cap *G* is fixed to the poles of the suspended magnet, and carries a pointed pin *w*. This is for the purpose of levelling or centralizing the moving magnet before using the instrument. This is accomplished at any time by adjusting the levelling-screws provided, so that the point just hangs over the fixed cross *R*, when the moving system should be quite free laterally. The action of the instrument will now be evident. When a current flows through the fixed coils, they develop the polarity *SN*, *SN* shown in fig. 73, and the magnet tries to turn in the direction indicated by the arrow around *w* so that its magnetic axis tends to coincide with that of the coils.

Then the angle through which the torsion head *H* and the attached pointer *P* has to be turned in the opposite sense (as indicated by the arrow around *B*), to bring the magnet and therefore the index *I* back to its zero position, is a measure of the moment of the couple, or force exerted by the coils on the magnet. This is also a measure of the current flowing through them, the angle of torsion of the upper end of *s*, indicated by *P*, being proportional to the force of torsion exerted by *s*.

It will be evident that the constancy in the accuracy of the readings given by this instrument depends on the constancy of the moving magnet, and also on the spring remaining undamaged.

The magnet can be raised or lowered, as may be found necessary for giving it freedom of motion, by turning *L*, and therefore coiling

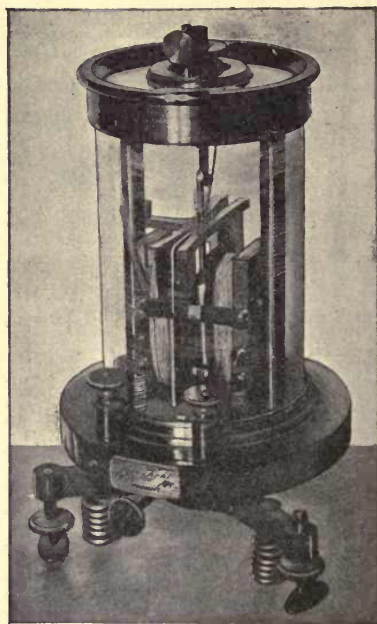

Fig. 74.—Siemens' Moving-Magnet Voltmeter

or uncoiling more or less of the suspending thread D on the rod E. A clamper is usually provided to clamp the magnet when the instrument is being carried about, in order to avoid breaking the suspension. The coils together usually have a total resistance of 100 ohms, and are wound with such a number of turns that 1 scale division = 0.01 volt. Thus, if the instrument has a scale of 360° , it would read 3.60 volts for one rotation of the torsion head H and pointer P to bring the index pointer I back to zero.

A general view of the complete instrument is shown in fig. 74, in which all the parts represented symbolically in fig. 73 are shown enclosed in a glass case to exclude dust and air draughts. A spring tapping key is sometimes provided on the base outside for completing the circuit at pleasure.

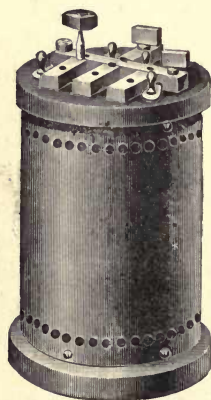

Fig. 75.—Adjustable Non-inductive Resistances

When it is desired to read higher voltages, such as, for instance, 0.1 or 1.0 volt per division, or in all 36 or 360 volts for a full scale, 900 or 9900 ohms must be put in series with the instrument, the extremities of the combination now forming the terminals of the voltmeter. These extra non-inductive resistances are usually contained in a ventilated receptacle, fig. 75, provided with a plug switch-top for inserting these resistances at pleasure.

As mentioned on p. 14, however, these should be wound with a material having a high specific resistance and low temperature coefficient of variation of resistance.

It will be seen from the foregoing considerations that there is a + and - terminal to the instrument, and that unless the circuit is

connected up correctly to it (+ to +), it will be impossible to take a reading.

Should it be desired to use the instrument as a low-reading ammeter, it must be connected in series with one of the mains. Then if 1 division = 0.1 volt, and since its resistance = 100 ohms, \therefore 1 division = $\frac{0.1}{100} = 0.001$ ampere. For large currents it must be used as a shunt to a standard known low-resistance strip, and the current deduced by Ohm's Law.

When using the instrument P is first turned to zero, and then the index pointer I is adjusted to zero by turning the instrument round, since the suspended magnet will require to lie approximately in the magnetic meridian of the earth. The position to which P has been turned on the top scale A in order to bring I to zero is then a measure of the voltage tested.

Fleming and Gimmingham's Voltmeter

This instrument, made by the Edison & Swan, Limited, Electric Light Co., is intended for the measurement of either direct or alternating electro-motive force. It belongs to the class of dynamometer measuring instruments, and depends in principle upon the fact that if a fixed and a parallel movable coil be traversed by the same electric current, the movable coil will be attracted towards the fixed one, and the force required to bring it back to its original position is proportional to the square of the current strength passing through the coils.

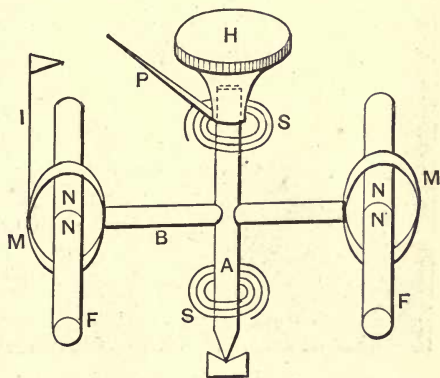

Fig. 76.—Principle of Fleming and Gimmingham's Dynamometer Voltmeter

Fig. 76 indicates briefly the principle on which the instrument works. MM are

two movable coils of fine wire, carried by a light arm B, which is in turn supported by a vertical spindle A.

This spindle A rests on a jewelled centre or footstep, and is controlled by hair-springs SS, which serve to lead the current into and out of the moving coils M. Each of the latter encircle a pair of

fixed coils FF at a point where their like poles touch, as at NN. A small index hand or pointer I is fixed to the moving system, whilst a mica-tipped pointer P is attached to a torsion or milled head H, to which the free end of the top spring S is attached.

The head H can turn quite independently of A, but causes A to turn by twisting up the spring S, thus forming the restoring or controlling force.

The position of the moving coils M is shown by the index pointer I, which plays between two stops on the edge of the scale (not shown in fig. 76).

In order to use the instrument, it is set on a level table, and if the index pointer I on the movable coils does not swing freely across the slot in the dial, level the instrument by means of the wooden wedge provided for that purpose. Turn the central milled head H until the index I is over the zero of the scale and note if the pointer P is also at zero, if not, firmly press the boss on which the mica

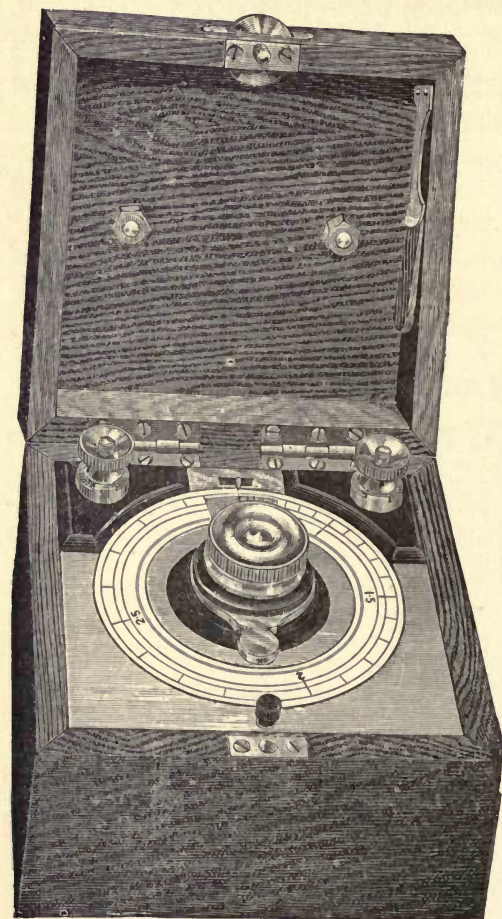

Fig. 77.—Fleming and Gimingham Voltmeter

pointer P is fixed while slacking the milled head H; the pointer and index can now be adjusted to zero, after which the index boss must be again firmly pressed and the milled head tightened. When the E.M.F. to be measured is applied to the terminals the index I will immediately fly to the left hand of the slot. Now twist the central milled head H carrying the mica-tipped pointer round in

the same direction as the hands of a watch travel until the index is brought back to zero. The volts are then read off directly on the dial under the pointer line on the mica. A little practice will enable a steady E.M.F. of about 100 volts to be read to less than one-quarter of a volt.

The act of fastening the lid of the box raises the movable coil off the pivot, and in order to prevent this action being too sudden the lid is closed with a screw. To open the lid, turn the milled ring projecting from the front of the case to the right.

When it is desired to carry the instrument about, or whenever it is not in use, the lid should be closed and the fastening screwed quite home. Inattention to this will cause a diminution in sensitiveness of the instrument.

After readings have been taken the mica-tipped indicator P should be turned back to zero, so as to take all strain off the hair-spring.

The central milled head should not be unscrewed unless absolutely necessary for the adjustment of zero.

These instruments have been found to be equally accurate for direct or alternating E.M.F., within the range of periodicity usually employed in alternating currents.

A contact key is supplied with the instrument, and the current should only be kept on during the actual reading of the E.M.F.

The instruments are fitted with a small series coil of resistance wire which can be thrown into circuit by means of a plug contact, thus doubling the reading.

A number of improvements have lately been introduced in the winding of the coils, the jewelling of the pivot, and the method of conducting the current to the suspended coils.

The best and most open part of the scale can be taken as from half the maximum reading, upwards.

Fig. 77 shows the general view of the complete instrument.

Parr's Direct-Reading Dynamometer Ammeter

The Siemens' electro-dynamometer described on p. 14 is a most useful instrument for accurately measuring indiscriminately either continuous or alternating current, using one and the same scale calibration for either current. This, coupled with the fact that it is independent of the periodicity and "wave form" of the alter-

nating current, makes it a valuable instrument in a testing-room or laboratory.

The instrument, however, lacks some useful features in that it is *not portable, not direct-reading*, can practically only be used in the laboratory, and necessitates a slight calculation, involving taking the square root of the reading in order to obtain the current strength in amperes. Trouble also is frequently experienced in the breaking of the suspension, and the consequent alteration of the constant owing to the spring getting damaged in taking it off to re-suspend the moving coil.

These disadvantages led the author to devise an instrument which has all the advantages of the Siemens' dynamometer without its disadvantages, and which is illustrated in part sectional front elevation and plan in fig. 78.

It depends for its action on the mutual force of repulsion between two coiled circuits, carrying either the same or different currents, one circuit being fixed and the other movable. It consists of two fixed coils *m m* wound with copper strip about $\frac{1}{2}$ inch

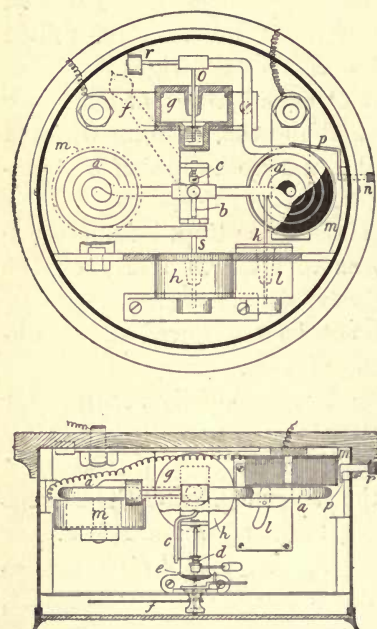

Fig. 78.—Principle of Parr's Moving-Coil Ammeter (section)

wide, the turns being insulated with silk tape between them. *a a* are two flat aluminium coils, carried on a horizontal arm fixed to a vertical spindle *b*, which is pivoted in jewelled centres.

To this vertical spindle *b* is rigidly attached a light horizontal arm *c*, and to the end of this is soldered a thin flexible metallic strip.

This strip passes almost once round a special V-grooved pulley *d* to which the end is soldered, and which is carried by a horizontal spindle pivoted in jewelled centres. This spindle, with the moving coils to which it is geared, is controlled by two hair-springs *e* set in opposite directions, so that as one coils up the other uncoils, thereby preventing errors due to fluctuations of the zero by changes

of temperature altering the length of the springs. The horizontal spindle also carries the pointer f and its balance-weight. A movable arm, seen between the pointer and springs, enables the tension of the latter to be adjusted so as to set the pointer f to zero on the scale, should this at any time be necessary. Current is led into and out of the moving coils $a a$ through two non-spillable mercury cups g and h , into which dip pure copper prongs that form the ends of the movable aluminium coils $a a$.

These latter are in series with the two fixed coils $m m$, and are so connected that each fixed coil repels its adjacent moving coil. A fine hard wire k is attached to the moving coils, and carries at its lower end a light vane which dips into a viscous liquid contained in a trough l , which does not permit of it spilling. By means of this damping arrangement the instrument can be made *dead-beat* to any desired extent. In the latest construction, however, this liquid damper has been replaced by the more satisfactory air damper fitted above the cup g , the air vane which moves in the closed box being fixed to the upper extension of the moving coil, and moving concentrically with it.

These latter can be clamped during transport by a bar p , which can be turned down in front of the right-hand moving coil by a milled nut n outside the case of the instrument. The moving coils just touch the fixed ones when the pointer stands at zero on the scale and no current flows. When a current passes through the instrument, the force of repulsion between each pair of fixed and moving coils is \propto to the square of the current.

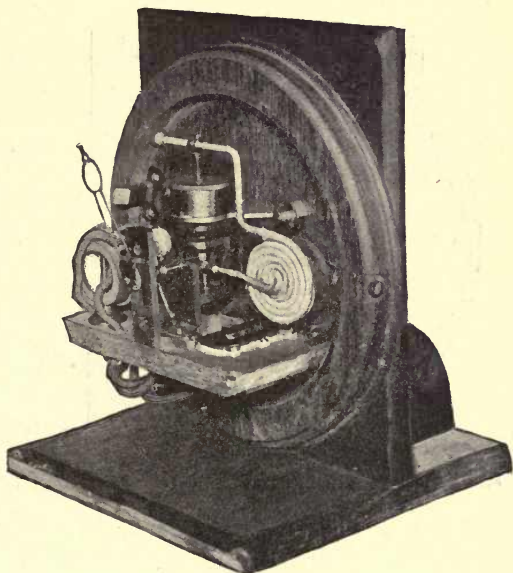

Fig. 79.—Interior of Parr Moving-Coil Ammeter

But this force falls off \propto to $\frac{1}{d^2}$ approximately, d being the distance between each fixed coil and its corresponding moving one. Hence the current is \propto to d , *i.e.* \propto to the angular motion of the pointer f approximately, the controlling force of the springs being \propto to the angular deflection of f .

The scale graduations are therefore extremely open and nearly equal from end to end of the scale, which extends over about nine-

tenths of the circular dial. Fig. 79 shows a photo of the internal parts of an actual ammeter, with scale dial and case removed to show them more clearly, while fig. 80 shows the general view of the complete instrument. As seen, these instruments are of the switch-board type, *direct-reading*. They contain *no iron* whatever, and very few metal parts, consequently they will measure the *true current in any alternating-current circuit*, being quite unaffected by the

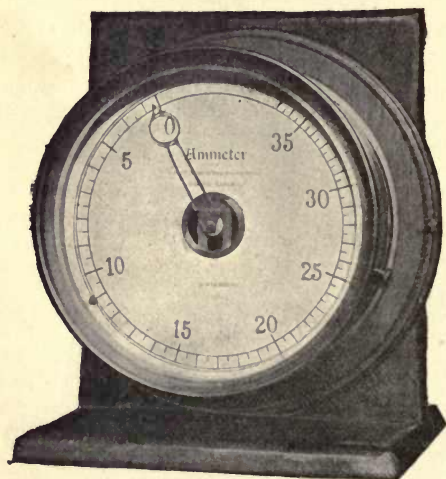

Fig. 80.—General View of Parr Ammeter

periodicity and "wave form" of the current.

They also read equally accurately with direct currents. In the latest form for heavy currents the instrument is shunted to a low-resistance strip, goffered to such an extent that it has a self-induction equal to that of the coils of the instrument. No error is thereby introduced, and the coils inside now only carry a few amperes instead of the whole current.

Parr's Direct-Reading Dynamometer Voltmeter

This instrument is constructed in precisely the same way as that just illustrated and described. The only difference being that both fixed and moving coils are wound with fine insulated wire and carry the same current, though it is only a potential current. The resistance of the four coils in series amounts to between

3000 and 4000 ohms, so that an instrument reading to 120 volts and which would have the above resistance would pass only a very small current and consume little power.

The scale graduations commence at about one-twentieth of the maximum reading and are nearly uniform in width to the end.

The instrument, like the preceding one, is of the switch-board type, direct-reading, and has a scale extending about nine-tenths of the circular dial.

It is, of course, more successful when used with direct currents than with alternating, owing to the coils possessing some slight self-induction.

There is, however, no iron in its construction and but few metal parts, so that small variations of periodicity do not affect the reading.

Moving-Coil Alternating-Current Voltmeter

Instruments that will measure direct currents accurately, and at the same time be sensitive, reliable, and sufficiently dead-beat for a reading to be taken with a fluctuating load, have been in existence for some time. Instruments intended for the measurement of alternating currents, which shall have these most desirable attributes, are much more difficult to obtain, and should fulfil an additional requirement, namely, that their indications should be independent of the "wave form" and periodicity of the circuit.

Further, it is a valuable feature when one and the same instrument will read equally accurately when employed with either a direct or an alternating current on the same scale.

Unfortunately, however, there are but few instruments in existence that fulfil all these desirable requirements simultaneously.

Those at present under discussion, which are made by the Electrical Company, London, meet the above conditions as far as perhaps can be expected with alternating-current instruments.

The principle on which the voltmeter now to be described is constructed is applicable also to ammeters and wattmeters, and each is constructed with dynamometer movements and has magnetic damping. Fig. 81 shows the arrangement in side elevation and fig. 82 in plan, from which the construction will be understood.

In most instruments of this class a permanent magnet cannot be used for damping. The reason for this is well known, since not only is the magnetic field of the instrument distorted and

the reading of the scale interfered with, but also the permanent magnetism is gradually destroyed by the action of the alternating current, so that the damping finally is altogether lost.

These effects, or rather defects, are completely eliminated in the special arrangement adopted in the following instruments, thus permitting the use of magnetic damping.

The body of the instrument is built up of laminated sheet-iron with an internal and circular space, within which is placed the stationary coil FF, consisting of two windings.

Between these windings is the spindle A, carrying the moving coil B, to which the current is led by means of spiral springs, the latter also acting

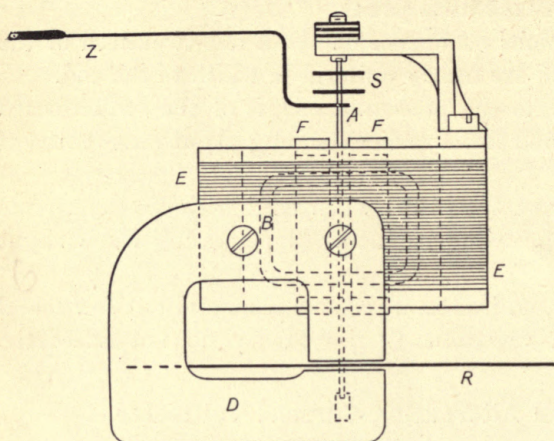

Fig. 81.—Principle of Electrical Company's Moving-Coil Alternating-Current Voltmeter (side elevation)

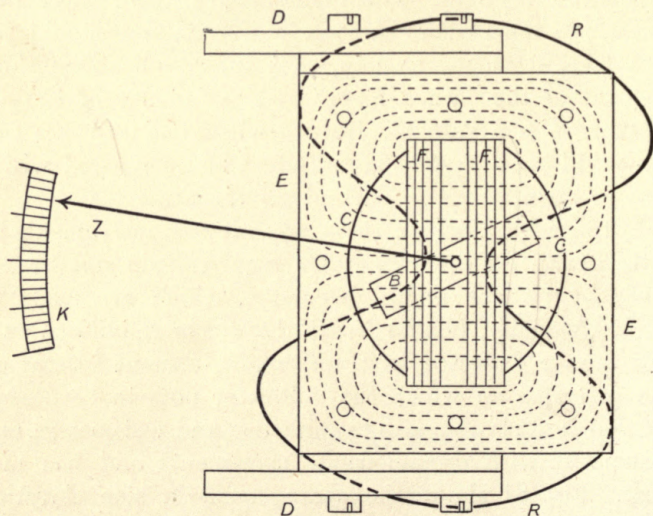

Fig. 82.—Principle of Electrical Company's Alternating-Current Voltmeter (plan).

these windings is the spindle A, carrying the moving coil B, to which the current is led by means of spiral springs, the latter also acting

as the controlling force. The spindle A further carries the pointer Z, which moves over a scale graduated empirically, and the aluminium vanes B, the outer edges of which move between the poles of the two brake magnets D, and serve in the well-known manner by the generation of induced or eddy currents in them (p. 6) to damp the swings of the moving system.

The dotted lines in fig. 82 show the lines of force due to the stationary coil. In this arrangement of the iron circuit E with respect to the stationary windings, it is clear that the lines of force are completely enclosed within the iron box. Hence none of the lines pass through the damping magnets D, and in consequence the permanent magnetism of the latter is not impaired.

The interior of the instrument, however, in which the moving coil swings, is quite free from iron, the lines of force having only an iron path to complete the magnetic circuit—a fact of great importance for the electrical properties of these instruments.

Of the three classes of these instruments the voltmeter is the simplest.

The stationary and moving coils consist of properly proportioned fine copper wire, and are arranged in series together with the necessary dead resistances. The following are the details of the electrical portion of such an instrument having a range up to 125 volts.

The resistance of the winding, *i.e.* of the stationary and moving coils taken together, is about 130 ohms, the dead resistance, which is non-inductively wound, is about 2000 ohms, so that the total resistance amounts to 2130 ohms. The current is thus not quite 0.56 ampere and the power lost not quite 7.5 watts, a result decidedly favourable with an alternating-current instrument.

The dead resistance consists of a material which changes its resistance very little with temperature, so that the temperature coefficient of the whole instrument, taking that of the copper windings as 0.04, is 0.0024, so small a quantity that it can be neglected (*vide* p. 14).

The torque exerted depends on the current in the moving coil, and this in turn on the impedance $\sqrt{r^2 + (2\pi n)^2 l^2}$, where r = resistance in ohms, l = coefficient of self-induction, and n = frequency. Theoretically the readings of these instruments are therefore de-

pendent on periodicity. Practically, however, this is not the case, as r is so large compared with $2\pi nl$, that the impedance differs only very slightly from the ohmic resistance r . This is due to the space occupied by the coils being free from iron, and the lines of force only traversing the iron to complete their circuit. Hence the

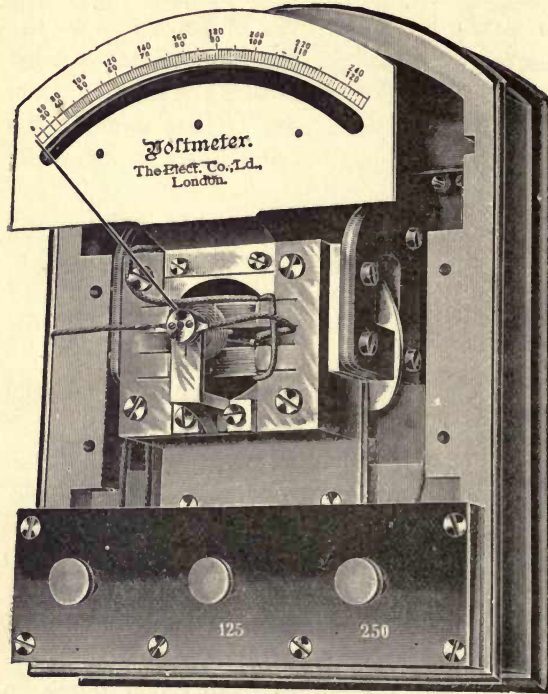

Fig. 83.—Interior of Electrical Company's Alternating-Current Voltmeter (case off)

path of the lines is partially through air and iron, the length of the air circuit being considerably longer than the iron one surrounding the main coils.

The effect of hysteresis is practically negligible, as the magnetization of the iron is very slight; and, further, variations in periodicity produce no effect, as the difference in the readings of these instruments with an alternating current of 50 cycles and with direct current

is so exceedingly small that the same instrument can be used for both alternating and direct current.

A voltmeter of this make is shown in fig. 83 with cover removed to show the internal parts more clearly. As seen it has two scales reading to 125 and 250 volts respectively, according to whether the extreme and centre or right-hand terminals are used. The double scale is the general practice in these voltmeters.

A strip of mirror is inserted close to the scale for the purpose of avoiding errors due to parallax when reading the position of the pointer on the scale.

Moving-Coil Alternating-Current Ammeter

The principle on which this instrument works is similar to that of the moving-coil voltmeter just described. The same remarks apply to this ammeter as do to the voltmeter, both being made by the Electrical Company. Fig. 84 shows diagrammatically the principle on which the ammeter works, the thick wavy line T being the thick fixed coils, and the thin wavy line F the fine-wire moving coil, which is shunted to the ends of a standard resistance R in the main circuit M.

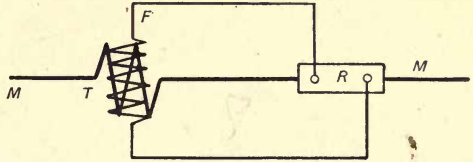

Fig. 84.—Principle of Electrical Company's Alternating-Current Ammeter

Fig. 85 shows the ammeter with the cover and scale removed, and also this resistance, R, which is fixed under the scale. This arrangement is the general one adopted in ammeters of the moving-coil type, the only difference being that the field is not produced by permanent magnets, but by the main-current coil. As the magnetic field cannot be so large as with a permanent magnet, all other conditions remaining the same, the resistance R is chosen larger to give a larger voltage for the shunt

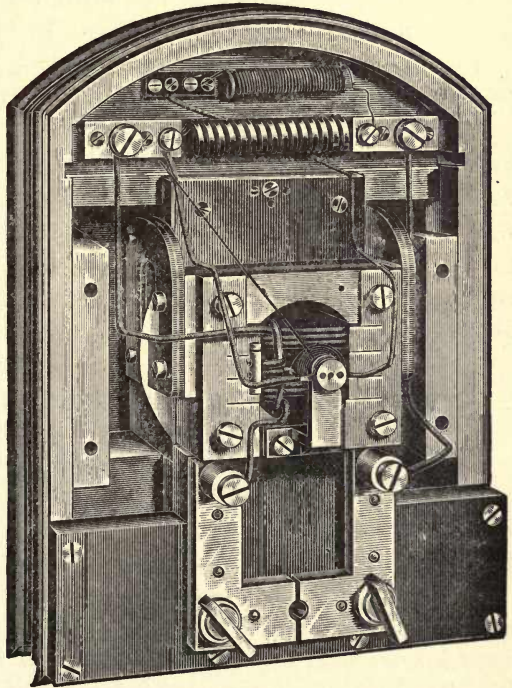

Fig. 85.—Interior of Electrical Company's Alternating-Current Ammeter (case off)

coil, and need not be mounted in the instrument itself, but separately. This is of advantage when the stationary coil of the

instrument is wound in two parts for connecting in series or parallel, when, of course, two resistances are necessary, with the corresponding terminals for making the proper connections. By so proportioning the resistance that its impedance always bears the same ratio to its ohmic resistance, and has the same temperature coefficient as the moving coil, the readings of the instrument will be independent both of periodicity and temperature. To attain

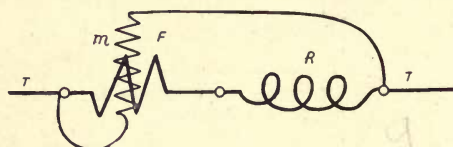

Fig. 86.—Principle of Compensating Alternating-Current Ammeter

this it is unnecessary to specially wind this resistance, the requisite impedance and temperature coefficient being produced by adding to the resistance the effect of the ampere

turns of the stationary coil as shown diagrammatically in fig. 86. In this way the ammeter is rendered independent of temperature, and of lag of phase of the current, so that the same instrument reads equally well with alternating and with direct current.

Recording ammeters for alternating currents are built on the same principle. By the use of the iron circuit and magnetic damping a larger turning moment can be obtained, an advantage with recording instruments. This, however, is not quite sufficient to overcome the friction due to the pen on the revolving drum, and necessitates a somewhat larger resistance than is used in the above ammeters.

The Weston Standard Portable Moving-Coil Voltmeter

The principle involved in the action of this instrument, which is supplied in this country by Messrs. Elliott Brothers, of London, is the electro-dynamic attraction and repulsion between fixed and movable fine-wire coils.

The control is that produced by springs of the usual form, and as the instrument contains no iron in its working parts, and only very few metallic parts, it can be used for the measurement of both direct and alternating current potential differences.

A skeleton plan of the working parts is shown in fig. 87, with certain minor omissions. *K* is a rectangular ebonite frame, having a circular hole through its interior in which the moving coil *c* can rotate. This coil is pivoted between jewelled centres, carried by

two cross strip brackets fixed to the top and bottom sides of K , and shown in fig. 88. The top pivot, carrying c , has fixed to it a light aluminium pointer P , which therefore indicates the motion of c .

Two fixed fine-wire coils MM are placed one on each side of the frame K , and are arranged so as to develop opposite polarity at the two sides facing one another.

Fig. 88 shows in perspective elevation the method of mounting the moving coil in the ebonite frame K . It is so clearly shown that any description would be superfluous, except for one detail. This consists of a light aluminium disc, carried by the lower steel

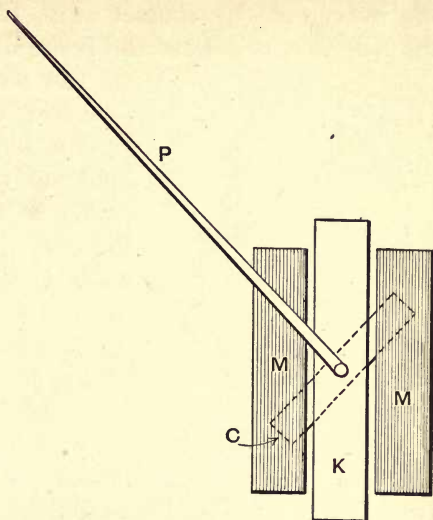

Fig. 87.—Principle of Weston Portable Moving-Coil Voltmeter

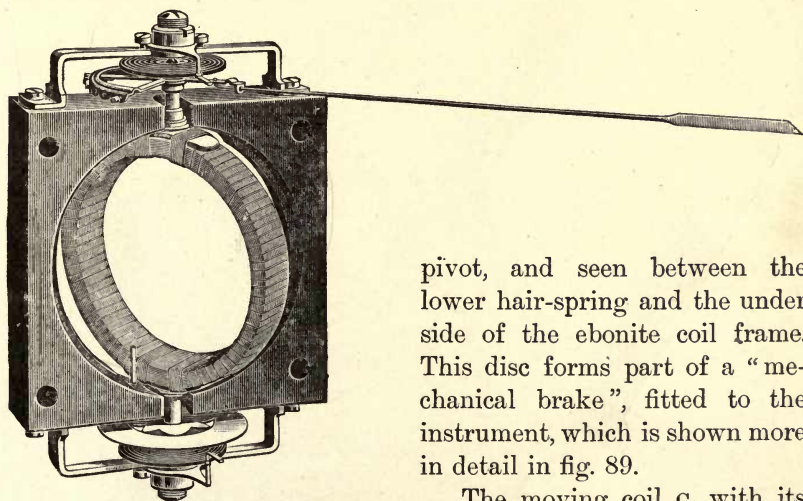

Fig. 88.—Moving Coil of Weston Portable Voltmeter

pivot, and seen between the lower hair-spring and the under side of the ebonite coil frame. This disc forms part of a “mechanical brake”, fitted to the instrument, which is shown more in detail in fig. 89.

The moving coil c , with its attached brake disc A , and indicated without the frame K , springs, or pointer, rests vertically between the jewelled centres. F is a button which, when depressed, first makes the circuit of

the instrument by contact at D. Any further depression causes the tongue B to release the brake disc A.

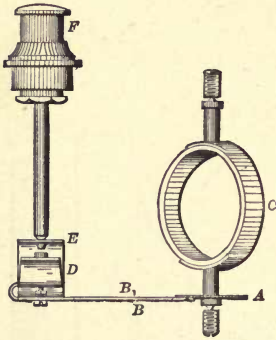

Fig. 89.—Mechanical Brake to Moving Coil

The tongue B consists of two parts—a stiff one B, which holds the disc rigidly for travelling purposes; and a light one B₁, which, by suitably pressing F, can be made to bear very lightly on the disc A, thus making a very delicate method of stopping the movements of the coil c.

A general view of the complete volt-meter is shown in fig. 90 inside the travelling case.

It will be noticed that the scale is marked with two ranges, representing two distinct sensibilities, which are obtained by suitably connecting to the three terminals shown.

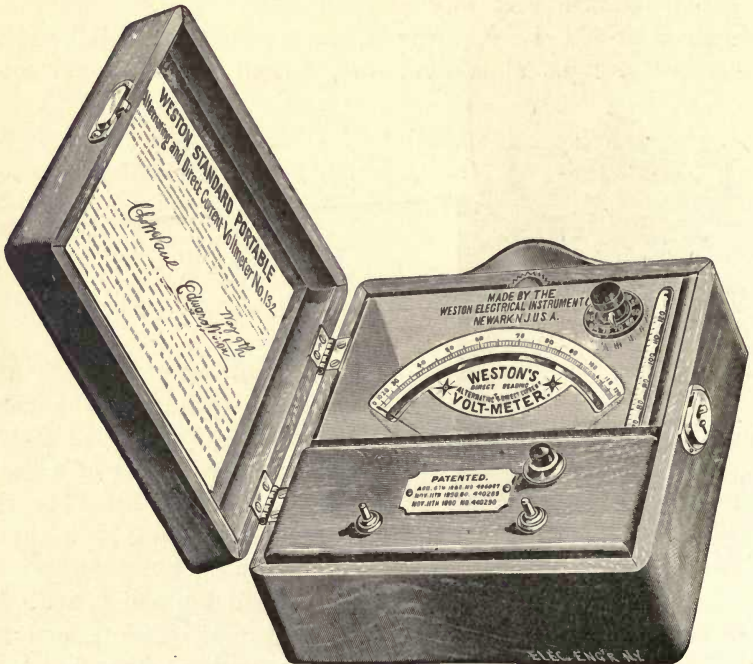

Fig. 90.—Weston Portable Voltmeter in Travelling Case

Illuminated-Dial Instruments

It is sometimes convenient to have the dials of measuring instruments illuminated to a greater extent than that obtained with the light of the room in which they are placed, as this enables them to be read at a greater distance. This can either be done

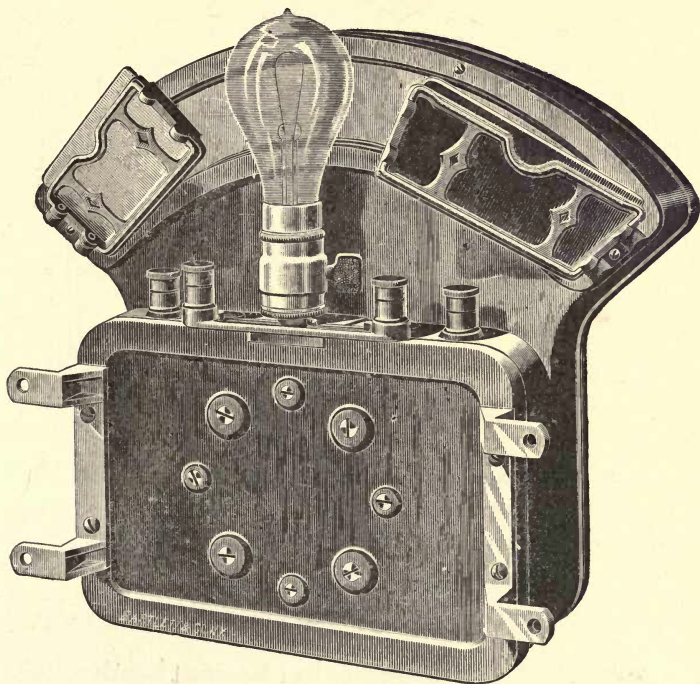

Fig. 91.—Back View of Illuminated Dial, Weston Voltmeter (Sector Pattern)

by a separate lamp, fixed just above the scale, a little in front of it, and arranged so that the light is reflected down on to the front of the scale; or the lamp is fixed to the instrument just behind the scale, which is then transparent. Figs. 91 and 92 show the way in which this is done in the case of a Weston illuminated-dial sector-shaped voltmeter, and the same would also be the case with an ammeter.

The scale is drawn on ground porcelain, and the glow-lamp is fixed directly behind this, in the middle. Two reflectors are bracketed at either end of the scale, and are so placed as to reflect

the light from the lamp on to the end portions of the scale, thus producing a uniform illumination from end to end.

In all cases the lamp must be so arranged with regard to the

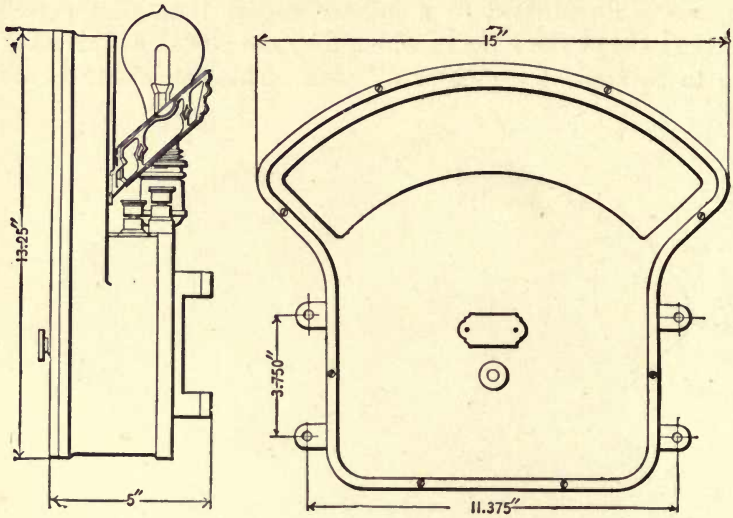

Fig. 92.—Illuminated-Dial Voltmeter

rest of the instrument that the heat from it can get away without in any way raising the temperature of the instrument; and this can best be attained by having it outside the case altogether, as shown.

Davies Moving-Coil Voltmeter

This voltmeter, manufactured by Messrs. Muirhead & Co., belongs to an important class of moving-coil instruments, with a permanent magnetic field, the principle of which is magnetically the converse of that met with in the electro-magnetic moving-needle type of measuring instruments. The principle on which this and all similar moving-coil ammeters and voltmeters work is simply that obtained in the ordinary D'Arsonval galvanometer. The construction, however, in the two cases is somewhat different, as will be at once seen, the Davies voltmeter being a special form of pivoted D'Arsonval galvanometer in which the moving coil moves through an unusually large angle, equal to about 220° .

In the perspective drawing, fig. 93, M is a powerful permanent steel magnet of cylindrical form, terminating at the top in a

peculiarly-shaped pole-piece E D, of highly permeable soft magnetic material. The portion D, which takes the form of half an s, is partly cylindrical, tapering slightly towards the free end, and has considerable

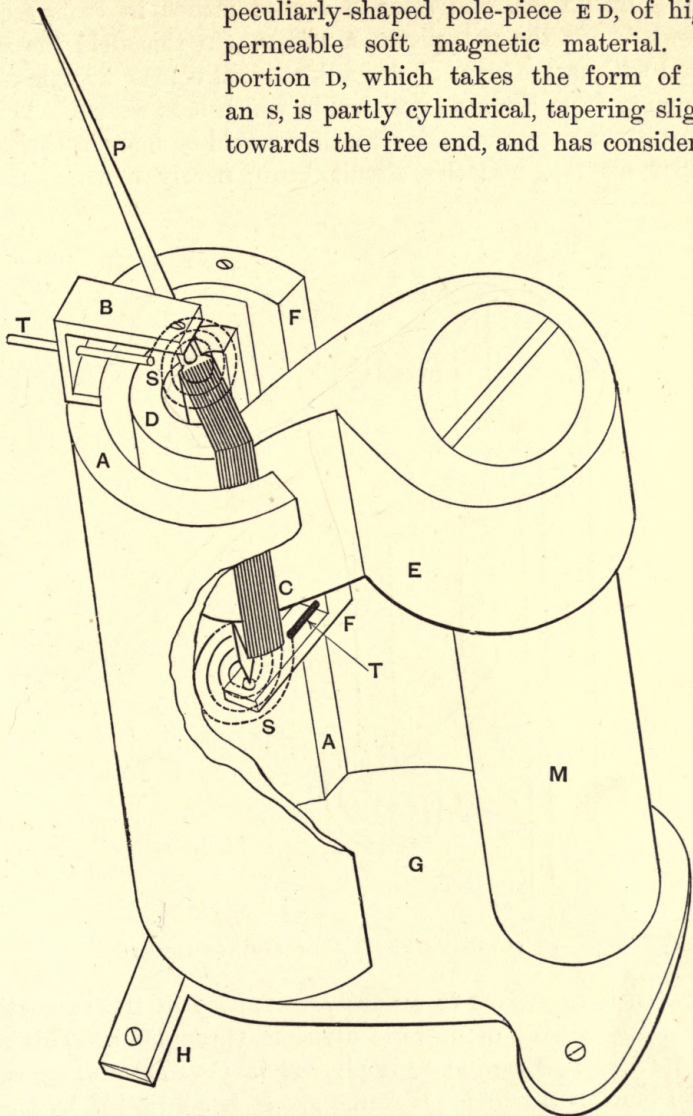

Fig. 93.—Principle of Moving-Coil Voltmeter

axial vertical length. M is carried by a sole-plate G, of good magnetic material, which in turn carries a cylindrical-shaped pole-piece A, concentric with D, of soft iron or mild cast steel. Hence a strong radial magnetic field exists in the air-gap—less

than $\frac{1}{8}$ inch wide, and some 3 square inches in cross-sectional area—between the pole-pieces A and D. In this field the coil C, wound with many turns of fine silk-covered copper wire, is capable of moving from the zero position, in which it is shown. Thus the permanent magnet maintains a uniform field of force in the narrow annular air-gap, and the circuit being nearly a closed one, its

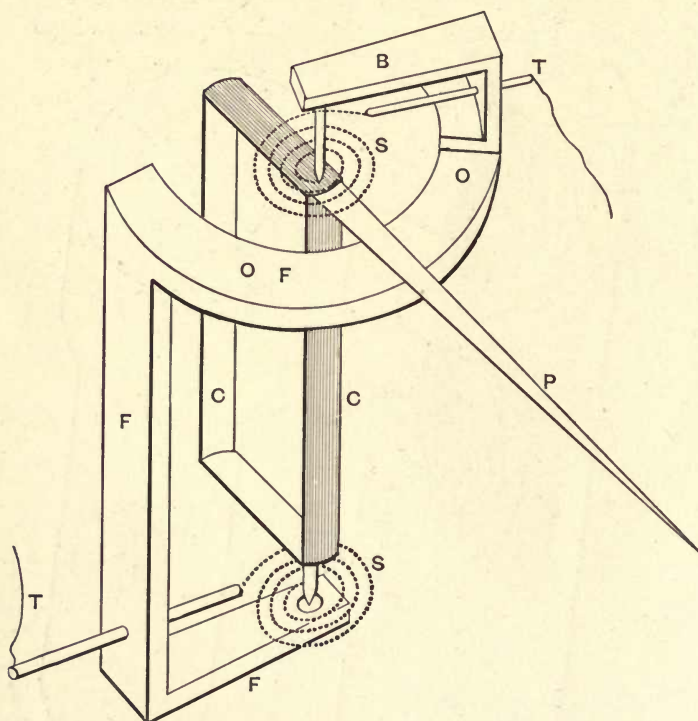

Fig. 94.—Moving Coil and Frame of Davies Voltmeter

reluctance is so low as to ensure permanency of the magnetic induction and a scale of uniform divisions throughout. This coil C, with its attached pointer P, is pivoted in jewelled centres, carried by the bracket B and brass frame F. It is controlled by the two hair-springs S, one at each end, set in opposite directions, *i.e.* as C turns, one coils while the other uncoils. This is in order to avoid the readings being affected by variations of temperature, causing an elongation of the springs. The free ends of the springs are attached to the rods T, which are insulated from the frame F, and form the terminals of the coil C.

A perspective view of the coil *c*, and the frame *F* which carries it, is shown detached from the instrument in fig. 94. Referring to this it will be seen that one vertical side of *c* forms a continuation of the spindles to which it is rigidly fixed, and is therefore in the axis of turning. The coil itself is wound on a collapsible former, which is finally removed, the vertical side just referred to being attached to a strip of aluminium foil, which is in turn rigidly fixed to the steel spindles, running in jewelled centres, and to the aluminium pointer *p*. The pointer, and therefore the coil, is limited in its angular motion by two suitably placed spring stops at the beginning and end of its motion. The current is led into and out of the moving coil *c* through the two hair-springs *ss*, and from a reference to

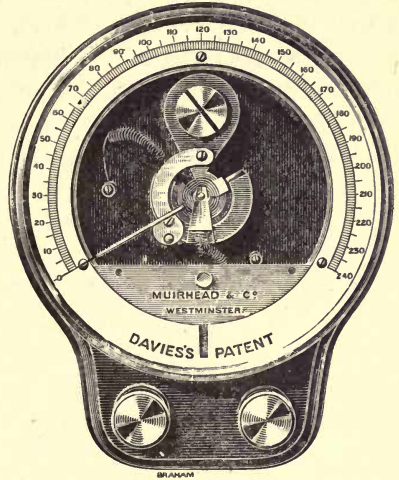

Fig. 95.—Davies Moving-Coil Voltmeter

figs. 93 and 94 it will be observed that only the outer vertical side of the rectangular coil *c* is in the magnetic field, the other side, in line with the spindles, being in the centre, and therefore inactive magnetically. Hence a current flowing through *c* causes its active side to move round the field between *A* and *D* against the torsion of the controlling springs *ss*, through an angle proportional to the current strength.

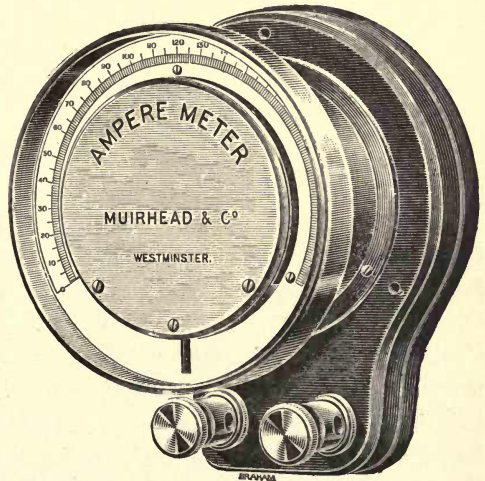

Fig. 96.—Davies Moving-Coil Ammeter

When the instrument is used as a voltmeter the moving coil *c* is placed in series with an extra resistance to keep the current

through it within the maximum limit. The coil *c* is very thin, and the pole-pieces *A* and *D* are very close together, being less than $\frac{1}{8}$ inch apart; this, coupled with the strong uniform field maintained between *A* and *D* and the way in which one pole-piece embraces the other, makes the readings of the instrument immune from the action of external magnetic fields. A general view of both a voltmeter and ammeter is shown in figs. 95 and 96, from which it will be seen that they have a very long range of scale, with the advantage that the graduations are uniform throughout, this latter result being

obtained by the coil always being in the same uniform magnetic field.

It should be noted that since instruments of this kind possess a permanent magnetic field, they can only be used with continuous currents, and consequently have a + and - terminal. Hence they will only work when the source of current is connected to them in the right way (+ to +).

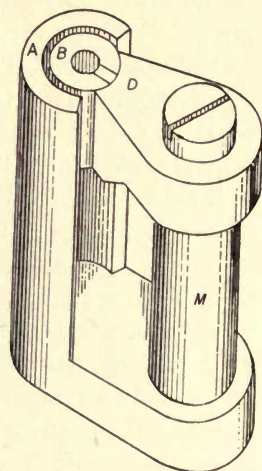

Fig. 98.—Permanent-Magnet System of Davies Voltmeter (present Bench form)

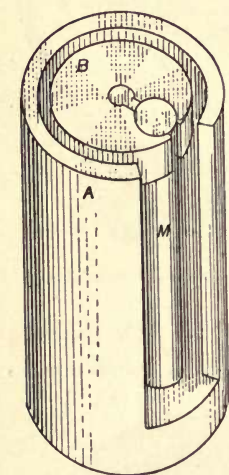

Fig. 97.—Permanent-Magnet System of Davies Voltmeter (early type)

Referring to fig. 93, it should be remembered that the form of pole-pieces, and indeed of the magnetic circuit generally, belongs to the earlier forms of this instrument, and that they have been improved recently by certain modifications of that magnetic circuit. One earlier form is shown in fig. 97, in which *M*, the permanent steel magnet part, consists of the vertical cylindrical bar, seen through the gap in the outer soft-iron cylinder *A*, and which supports the central soft-iron pole-piece *B*. A hole in the centre of this latter allows the side of the moving coil, which is in a line with the pivots, freedom to rotate.

A later design still for the magnetic circuit is shown in fig. 98, which closely resembles that depicted in fig. 93, the only difference being that the gap in the central soft-iron cylinder through which

the one side of the moving coil is inserted is closed after insertion by the remainder of the pole-piece (fig. 98). Experience, however,

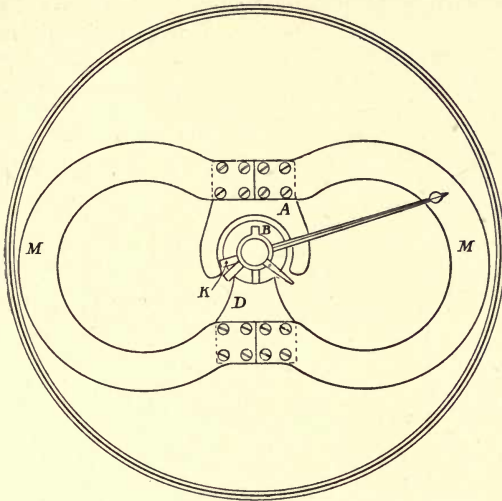

Fig. 99.—Permanent-Magnet System of Davies Voltmeter (present Switch-board form)

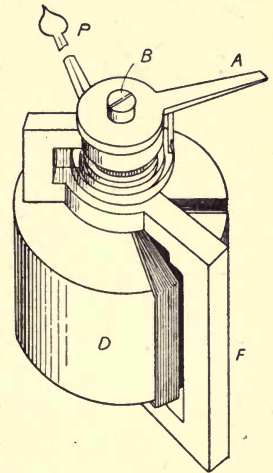

Fig. 100.—Central Pole-piece, Moving Coil, and Fixed Spindle Frame of Davies Voltmeter

has shown that more steel was necessary in the magnets, and this has led to the design shown in fig. 99, which is that used at the

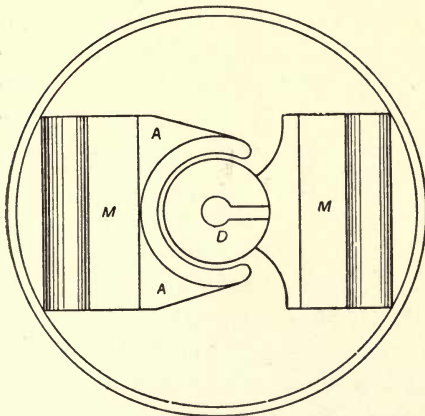

Fig. 101.—Permanent-Magnet System of Davies Voltmeter (plan of Bench form)

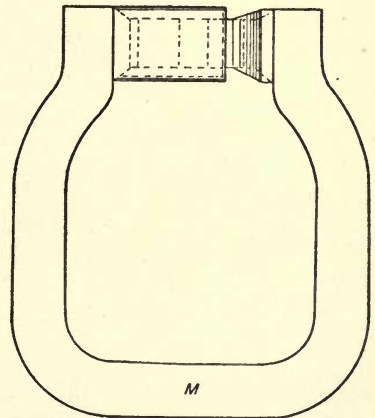

Fig. 102.—Permanent-Magnet System of Davies Voltmeter (side elevation of Bench form)

present time principally in the "switch-board" type, though it is also used in the "bench" or laboratory type of these instruments.

It will be observed that this construction resembles very closely the double magnetic circuit form of direct-current generator or dynamo, in which the two permanent steel magnets *MM* are in parallel, and together force the lines of force across the air-gap, in which one side of the coil *K* moves between the pole-pieces *A* and *D*.

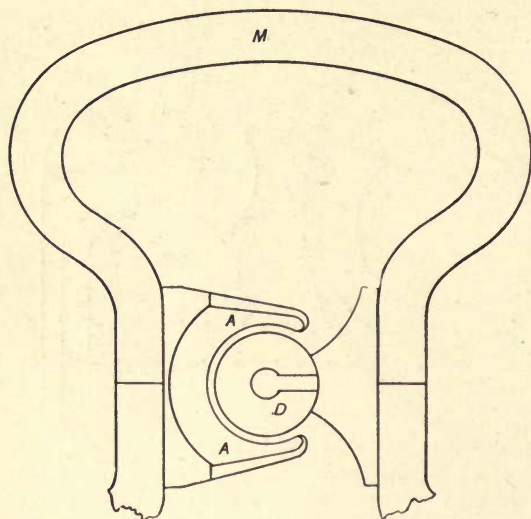

Fig. 103.—Permanent-Magnet System of Davies Voltmeter
(plan of Switch-board form)

Fig. 100 shows the central pole-piece, and the moving coil which sweeps round it, together with the fixed frame that carries the jewelled centres and springs, detached from the rest of the magnetic circuit.

The present bench form of instrument is shown in figs. 101 and 102, which give a plan and side elevation respectively, and the "switch-board" form in figs. 103 and 104, which give the same views respectively.

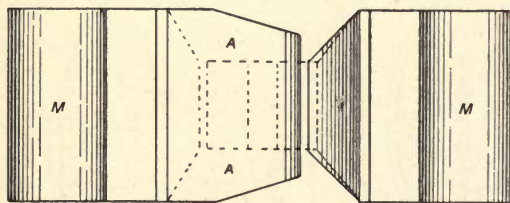

Fig. 104.—Permanent-Magnet System of Davies Voltmeter
(elevation of Switch-board form)

The induction in the gaps of these present forms varies from 750 to 900 C.G.S. lines.

The external appearance of the "bench" form is shown in fig. 105, and of course this has a horizontal scale.

In a voltmeter of this form, the moment of the force acting on the moving coil at a full deflection of 210° or 220° is about 0.8 gramme centimetre. The resistance of the moving coil for about 1 volt at its terminals is about 60 ohms, and the waste power about 0.016 watt under these conditions. For higher voltages this form averages 60 ohms per volt.

In the double magnetic circuit form (fig. 99), the moment of the force acting on the moving coil at a full deflection of about 210° is about 1.9 gramme cm.; the total induction in the gap is therefore large in this form. The resistance of the moving coil is about 100 ohms, and the drop of potential at its terminals about 1.8 volt, the corresponding waste of power being about 0.03 watt.

The resistance of a meter for 100 volts provided with strong springs for the deflecting force given above is about 5500 ohms.

If the "bench" and "switch-board" forms are given the *same strengths of springs*, the waste of power in the latter should be about half that in the former, and it is even less than half.

This applies, of course, to the ammeter as well as the voltmeter.

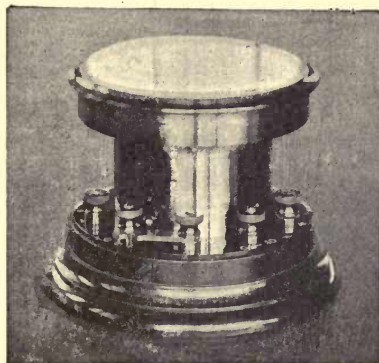

Fig. 105.—Davies Voltmeter (Bench form)

Electrical Company's Moving-Coil Am- and Volt-meters (For Direct Currents)

These instruments, in common with all others of the same kind, work on the D'Arsonval galvanometer principle, *i.e.* have a moving coil in the field of a powerful permanent steel magnet. They of course have a spring control, and are dead-beat.

The internal construction is shown in figs. 106 and 107, which respectively represent a side sectional elevation and front elevation of a voltmeter of this make. It consists of a permanent steel horse-shoe magnet *M*, carefully "aged" so as to maintain its magnetization constant. Its limbs terminate at the top in soft-iron pole-pieces, accurately turned; and between there is pivoted concentrically, in jewelled centres, a horizontal spindle (in two halves). This carries a pointer *P* and light rectangular moving coil of fine insulated copper wire, which is controlled by two hair-springs *S*, through which the current is led into and out of the moving coil. A cylindrical soft-iron keeper, or armature, *K*, is fixed concentrically with the spindles to cause a radial flow of magnetic lines of force

from the pole-pieces and concentrate them through the moving coil. The outer ends of the controlling springs *s* are connected to the

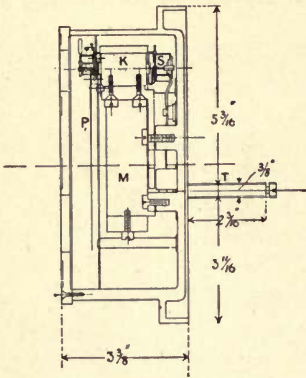

Fig. 106.—Principle of Electrical Company's Moving-Coil Direct-Current Voltmeter (side elevation)

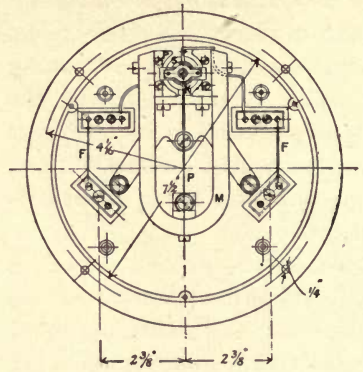

Fig. 107.—Principle of Electrical Company's Moving-Coil Direct-Current Voltmeter (front elevation)

back terminals *T* through two protecting fuses *F*. The fine wire of the moving coil being wound on a light metal frame, the Foucault currents, induced in this frame when it moves in the magnetic field, damp the motion, causing the pointer and coil to come instantly to any point on the scale, corresponding to a definite alteration of voltage.



Fig. 108.—Electrical Company's Direct-Current Moving-Coil Voltmeter

Since the field in which the coil moves is uniform throughout the whole range of its motion, the angular motions of the pointer and coil are directly \propto to the currents flowing through it, and a scale of equal divisions throughout is the result. The instrument absorbs little power, as the maximum current is only about $\frac{1}{80}$ ampere, and has the great advantage of being practically entirely unaffected by external magnetic fields.

Since, also, the control is produced by springs, these instruments can be read when resting in any position. When used as volt-

meters, these instruments have a high resistance in series with the moving coil, and are composed of a material having a low temperature coefficient of variation of resistance. By this means the errors due to variations of temperature altering the resistance of the instrument are practically eliminated.

Fig. 108 shows the general view of a voltmeter for 300 volts.

The ammeters of this type consist of a moving-coil instrument connected to the ends of a low resistance, which carries the main current, so that the instrument indicates the fall of potential due to any particular current in the low-resistance strip. The scale, therefore, can be marked off in amperes, since the current is proportional to this fall.

Fig. 109 indicates the arrangement, the massive bar at the bottom being the low resistance to which the instrument proper is shunted. The two are only separate for currents over 200 amperes. Up to this the shunt is fixed to the instrument.

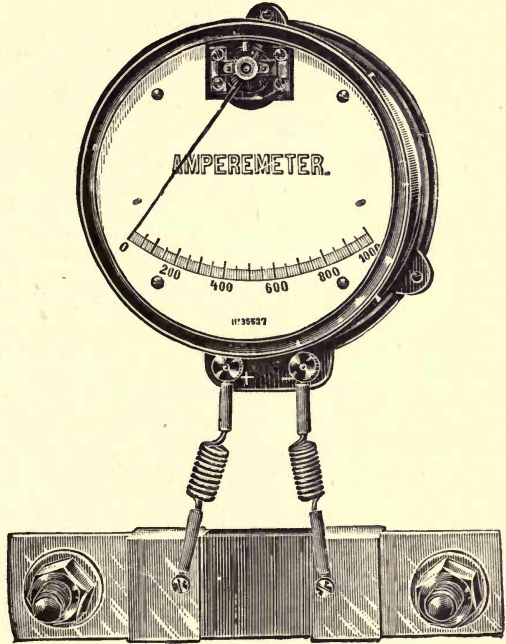

Fig. 109.—Electrical Company's Direct-Current Moving-Coil Ammeter, showing the Shunt

In some of these meters an index pointer is provided, capable of being set to any position on the scale by a milled head protruding beyond the dial or case. This may be set to the working voltage or current of the circuit, so that, when the pointer coincides with the index hand, the attendant can easily see the fact from a distance.

Siemens Bros. & Co.'s Moving-Coil Am- and Volt-meters

These ammeters and voltmeters, made by Messrs. Siemens Bros. and Co., of London, are of the permanent-magnet type. They are available for the measurement of direct currents only, and in common with all other instruments of this type, work on the principle of the D'Arsonval galvanometer.

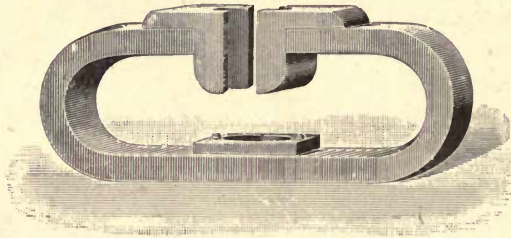

Fig. 110.—Permanent-Magnet System of Siemens' Moving-Coil Instruments

This particular *make* of instrument presents one or two features in its construction, which differ from those met with in similar instruments of the class.

Fig. 110 shows the form of permanent steel magnet used, which is designed to give a uniform magnetic field throughout the whole range of action of the coil. It is specially hardened, magnetized, and aged in order to ensure permanency.

The arrangement and fixing of pole-pieces, together with the footstep which holds the bottom of the frame that carries the moving coil, present some uncommon features.

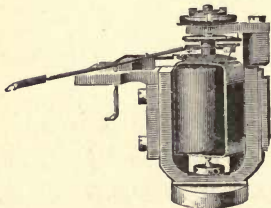

Fig. 111.—Moving-Coil System and Keeper of Siemens' Permanent-Magnet Voltmeter

The moving coil complete, with the frame in which it is pivoted, pointer, soft-iron keeper, and springs, is shown in fig. 111.

The induced or Foucault currents in the rectangular copper frame on which the fine-wire coil is wound, give a dead-beat motion to it.

Up to 50 amperes the low-resistance shunt, across the ends of which the fine moving coil is connected, is inside the instruments used as ammeters. In the voltmeters, a high resistance is placed in series with the moving coil.

The "Evershed" Moving-Coil Ammeters and Voltmeters

These instruments, made by Messrs. Evershed & Vignoles, of London, are similar in construction to all others belonging to this class of permanent-magnet measuring instruments, and have a spring control.

They embody the latest improvements which experience dictates, and possess some characteristic differences in the form of the moving coil and its fixings, which are interesting and instructive to note.

The permanent magnet, soft-iron pole-pieces, and core are fixed, once for all, to a brass framework.

The complete magnetic circuit, so formed, is then magnetized and brought into a condition of permanence, by a process which leaves every magnetic molecule in the circuit in a position of stable equilibrium.

Moreover, owing to the somewhat peculiar construction of the moving coil, which enables it to be inserted in position without taking the magnetic circuit to pieces, this source of instability in the magnetic system, a source met with in many types of moving-coil permanent-magnet instruments, is entirely removed in the Evershed pattern.

The moving coil and its accessories are shown in fig. 112, the construction being somewhat novel. The "former" F, on which the fine wire of the coil is wound, has two parallel rectangular sides which move in the narrow air-gaps of the magnetic circuit.

These two sides are joined at one end by a straight cross-piece, through which the light steel spindle passes, and at the other end by a circular ring-piece w, capable of just slipping

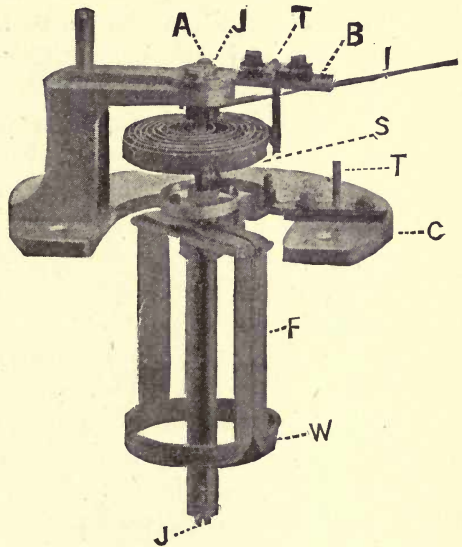

Fig. 112.—Moving-Coil System of Evershed Permanent-Magnet Voltmeter

over the cylindrical soft-iron keeper fixed concentrically with the pole-pieces, without touching either it or these latter.

The "former" F is attached to a brass sleeve, to which the controlling spring S, the leading-in strip or strips T, and the pointer I are also rigidly fixed.

A hardened-steel spindle passes through the sleeve, and is fixed thereto by a set-screw.

The spindle is ground to a needle point at both ends, the points resting in two caps of hard sapphire J J.

By this construction the parts liable to wear, namely, the needle points and jewels, are easily renewed or repaired, without separating the essential working parts of the instrument.

An internal zero adjustment is provided by the screws A A, which fix the lever B, and by loosening them any required adjustment can be made.

This should only be used in case of a permanent alteration of zero; and no notice should be taken of any temporary zero error due to fatigue of the spring after prolonged deflection in one direction.

A half-ring-shaped plate C, carrying the bracket to which one of the centres is attached, is screwed to the pole-pieces, and prevents all side play of the spindle in the sapphire centres.

The Evershed patent magnetic shield used in the electromagnetic moving soft-iron needle instruments of this make, is fitted in all but the edgewise pattern moving-coil ammeters and voltmeters, which are almost wholly iron-cased, and therefore effectively shielded from external magnetic fields.

The whole of the working parts in these moving-coil instruments are attached to a metal frame, entirely independent of the case, the frame being fixed in the latter by means of bushed screws, so that the case may be earthed for safety on high-tension circuits, if necessary, without any risk of damage to the instrument.

The moving coil in the voltmeters consists of many turns of fine copper wire, connected in series with a high-resistance coil, wound in a single layer on one or more porcelain tubes. This method of winding presents a maximum radiating surface for the heat generated in it, and prevents turns of wire at very different potentials from coming into close touch with one another.

This series resistance does not vary with temperature, and

as its value is usually hundreds of times greater than that of the moving coil itself, there is practically no error due to change of temperature.

The moving coil in the ammeters consists of a few turns of thicker copper wire connected in series with the two leading-in strips, and a series resistance made of the same alloy as is used for the resistances of the voltmeters. This resistance is adjusted until the potential difference on the ammeter terminals, when the latter are connected across a shunt through which the main

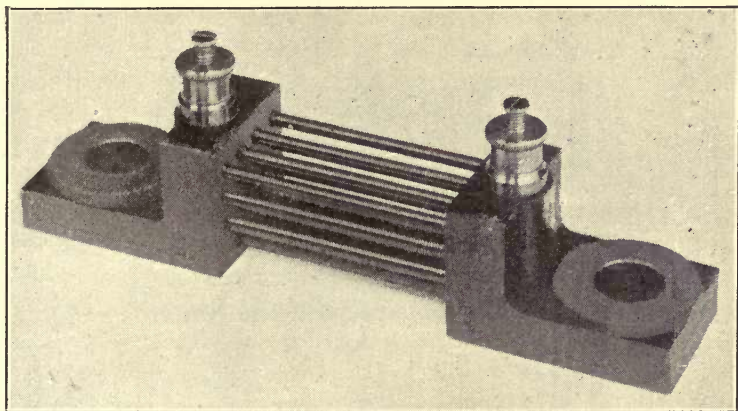

Fig. 113.—400 Ampere Low-Resistance Shunt for Evershed Ammeters

current passes, deflects the pointer to the required point on the scale.

The temperature error may be reduced to any extent by increasing the value of the series resistance, but the instrument then requires a higher potential difference to work it. Messrs. Evershed & Vignoles have adopted a value for this drop of voltage which is a reasonable compromise, and gives a moderate temperature variation of resistance with small waste of power in the shunt.

In these ammeters, the whole resistance of the moving-coil circuit is about 0.5 ohm; and so low a resistance makes it absolutely essential to connect the shunt to the instrument by leads having, approximately, the same resistance as those used for the purpose during the calibration. These have a total resistance of 0.015 ohm.

Two forms of low-resistance shunts for carrying the main

current can be supplied with the moving-coil ammeters of this make.

Fig. 113 shows the usual form of such. They have a carrying capacity of 200 to 400 amperes, and consist of a number of thick wires, soldered into massive terminal castings of pure copper, a method of construction which secures ample ventilation. The wires are made of an alloy having no variation of resistance with temperature, thus making the resistance of the shunt constant within the range of current used.

An enclosed form or external shunt is shown in fig. 114.

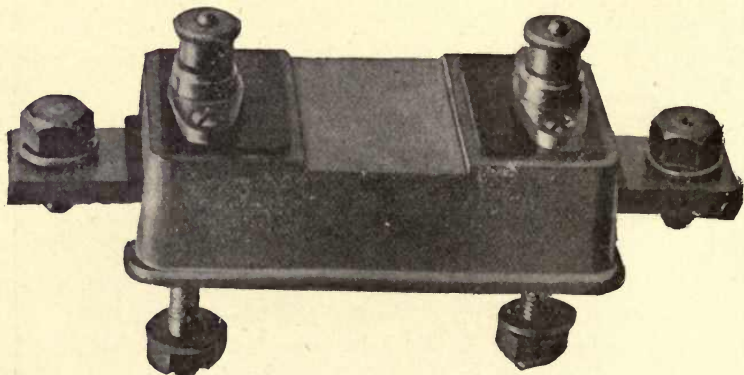

Fig. 114.—Enclosed Form of Low-Resistance Shunt

In each type the small terminals are the potential ones, and are connected to the instrument, while the larger ones form the connections to the main-circuit cables.

The Evershed moving-coil ammeters and voltmeters can be supplied in either the round, sector, or edgewise forms, the last-named having resulted from a demand for measuring instruments which should combine with minimum width the advantages of a long open scale visible at a considerable distance, and in this way economize switch-board space.

The radii of the scales in the usual sizes vary from 7 inches to 15 inches, and the widths from $3\frac{1}{2}$ inches to $5\frac{1}{4}$ inches. The arc of the scale is 60° , which is the longest that can be used consistently with avoiding excessive parallax at the ends of the scale.

The lengths of the scales are consequently about equal to the radii.

The "N.C.S." Moving-Coil Ammeters and Voltmeters

These instruments, made by Messrs. Nalder Bros. & Thompson, are of the permanent-magnet dead-beat type, and have a spring control.

Figs. 115 and 116 show the construction, which is as follows:—

The moving coil, MC, consists of a specially-shaped flat coil of double silk-covered fine copper wire, wound on either a very thin copper or aluminium frame or former, which is continuous in itself. The winding of this flat coil is varied to suit the purpose for which the instrument is intended.

Thus, an ammeter has a small number of turns of rather larger wire than usual, and a low-reading voltmeter many more turns of much finer wire; whereas a very high-reading voltmeter has a large number of turns of very much finer wire.

Broadly speaking, allowing for a certain amount of resistance, in the form of a coil of wire wound with a material having a low temperature coefficient, in series with the moving coil when used for ammeter purposes, a fall of potential of 0·08 volt across the terminals of the shunt will give a full-scale deflection.

A full-scale deflection can, however, be produced with a much smaller fall of potential, at the expense of a higher temperature error, by winding the moving coil with finer wire.

In a voltmeter the resistance of the moving coil bears a very small ratio to the total resistance of its circuit, as a high resistance,

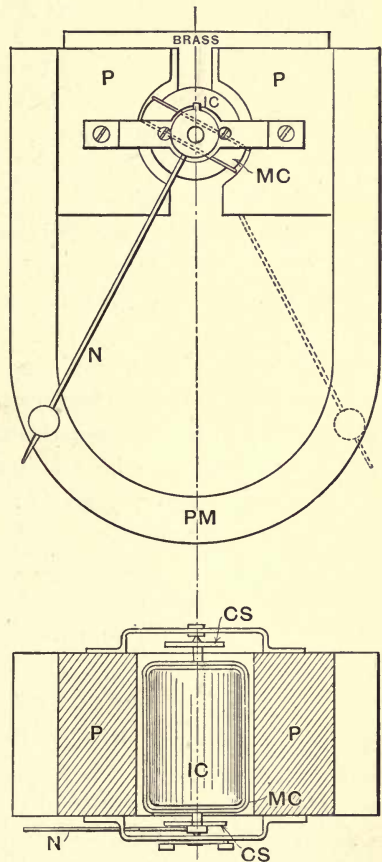

Figs. 115, 116.—"N.C.S." Permanent-Magnet Instrument

having a low temperature coefficient, is placed directly in series with it. Hence the temperature error is quite negligible.

Mounted on the coil, at the top and bottom, are two light steel pivots, each of which carries a hair-spring *CS* of phosphor-bronze or copper. These serve to lead the current into and out of the moving coil, and also act as the control.

A pointer *N* is attached to one of the pivot stems for indicating the motion of the coil *MC*, and the pivots work in jewelled centres carried by fixed end brackets.

This coil is pivoted between the soft-iron pole-pieces *PP*, terminating the limbs of a powerful permanent steel magnet *PM*. The pole-pieces *PP* are so shaped as to embrace the coil very closely with the least possible air-gap, and to give as nearly as possible a uniform field throughout the whole arc of motion of the coil.

Special means are employed in making, hardening, magnetizing, and ageing—this last being an extremely important part of the manufacture for ensuring the magnetism remaining constant with time—to obtain the best magnets possible.

Such magnets are usually made and stocked for a considerable time before they are used, and the flux or magnetic field measured before and after the ageing process.

Should this fall by any but a very small percentage, the magnet is rejected, and in this way permanency with time is ensured.

To direct the lines of force and concentrate their flow through the moving coil, as well as to ensure them flowing radially with regard to the poles *PP*, a solid soft-iron core or cylinder *IC* is fixed concentrically with *PP* and between them. The moving coil is just able to rotate through the requisite arc between *PP* and *IC* without touching either.

The coil with its attached pointer is very light, and its motion is made dead-beat by the retarding effect of the Foucault or eddy currents induced in the metallic frame on which it is wound when moving across the magnetic field between the poles *PP*. The pointer should be very light to gain the full advantage of this dead-beat action.

The Stanley Moving-Coil Ammeters and Voltmeters

These instruments, made by the General Electric Company, of London, are of the permanent-magnet class of measuring instrument. The moving coil is controlled by two phosphor-bronze hair-springs, which also serve to lead the current into and out of the coil, and the motion of this latter is dead-beat (see last paragraph).

The construction is very similar to that of the Weston moving-coil instrument (p. 102), and the principle on which it acts (that of a D'Arsonval galvanometer) precisely the same. In the voltmeter a high resistance is connected in series with the moving coil, and the extreme ends of this combination are joined to the terminals of the instrument. In the am-

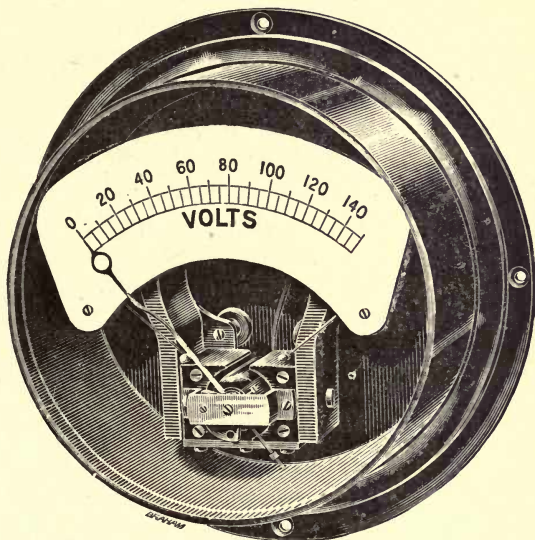

Fig. 117.—Stanley Permanent-Magnet Voltmeter

meter the moving coil is placed as a shunt to a low-resistance strip, which carries the main current.

The scales of these ammeters and voltmeters, in common with all makes belonging to this type of instrument, are uniformly graduated from end to end with equal divisions. Fig. 117 shows the general view of a Stanley moving-coil voltmeter with front cover removed. The permanent steel horse-shoe magnet, together with the rest of the working parts, can be seen by a reference to this illustration.

The Weston Ammeters and Voltmeters

These instruments, supplied only by Messrs. Elliott Bros. in this country, work on the principle of the D'Arsonval galvanometer, and have a moving coil actuated by a permanent magnetic field,

and controlled by hair-springs. Fig. 118 shows line drawings of the principal parts of the instrument in plan and end sectional elevation.

Referring to these, *M* is a carefully-selected, well aged, powerful permanent steel magnet, bent somewhat into the shape of a horse-shoe. The polar limbs *N* and *S* carry soft-iron pole-pieces *w* screwed to them, as shown. These are bored out so as to be truly cylindrical.

Screwed to each end of the pole-pieces *w* are two brass plates *r*, having a projection *H* at their centre region. Between these, and to them, is screwed a turned solid soft-iron cylinder *K* concentric with *w* and of the same axial length.

Capable of turning in the narrow air-gap, between *w* and *K*, is a rectangular coil of fine insulated copper wire *c*, wound on a light aluminium frame. This is carried by two pivots *s*, running in jewelled centres *J*, which are supported by the brass brackets *b* screwed to *w*.

The pivots *s* are not both in electrical connection with the coil frame, but are in electrical connection with the coil *c*, thus constituting really the terminals of it.

Each pivot *s* carries a phosphor-bronze hair-spring *F*, the free end of which is attached to an adjusting arm *a* having a bent end *d*. The arm *a* is capable of turning about *J*, and thus altering the tension of the spring *F*. The springs are similar in all respects to each other, but are set in opposite directions, so that as one coils up the other uncoils. This neutralizes any effect on the position of the coil *c* due to the expansion or contraction of the springs through temperature variations. A light aluminium pointer *P* is attached to the top pivot *s*, and, as shown, is in the position of a half-scale deflection, the scale itself not being shown in fig. 118. The extremely small potential current is led into and out of the moving fine-wire coil *c* via the arms *a*, springs and pivots at each end of the coil, the terminals of the instrument being connected to the arms *a*.

The action of the instrument, like that of all others belonging to this permanent-magnet moving-coil class, is due to the moving coil, when carrying a current, endeavouring to turn so that its own lines of force coincide in direction with those of the permanent field.

Owing to the air-gaps between *w* and *K*, in which the very thin sides of the coil *c* move, being very narrow, the lines of force due to *M* distribute themselves almost radially and uniformly between

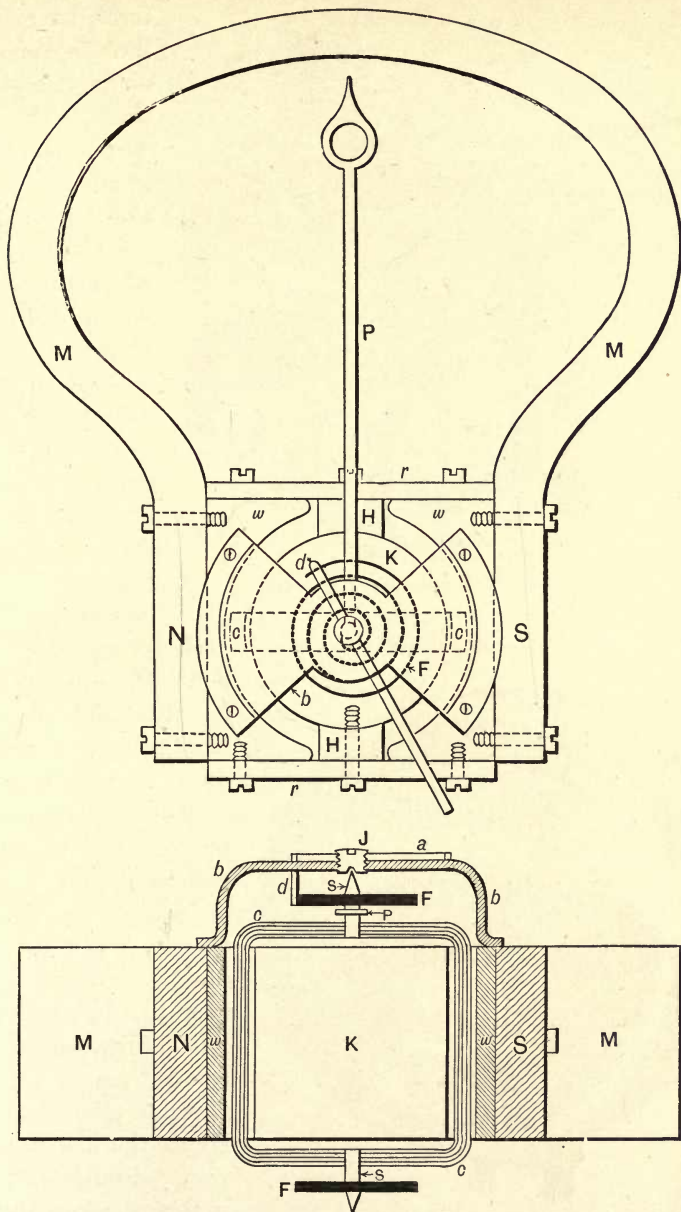

Fig. 118.—Principle of Weston Permanent-Magnet Voltmeter (plan and elevation)

the tips of each pole-piece. Hence the deflecting force is exactly proportional to the current in *c*. On the other hand, the controlling

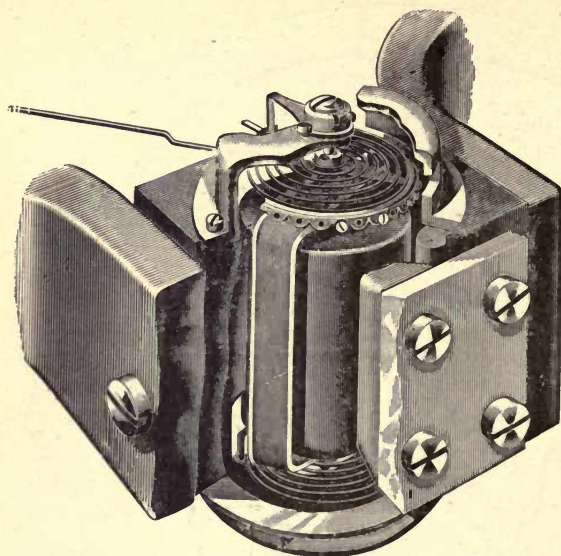

Fig. 119.—Weston Permanent-Magnet Voltmeter

uniformly-divided scale, the divisions of which are equal throughout. It is essentially a potential measurer, and can only be used for direct-current work.

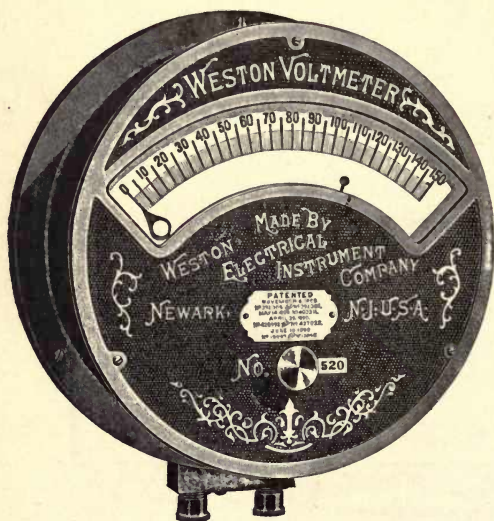

Fig. 120.—Weston Permanent-Magnet Voltmeter

force exerted by the springs is directly proportional to the angular motion of their ends; and hence also to that of c .

Consequently, when the deflecting and controlling forces balance, *i.e.* when the pointer shows a steady deflection on the scale, the current in c is directly \propto to the angle of turning. Hence this instrument has a

The oscillation of the moving coil c and its pointer P , over the scale, is checked by the "induced", "eddy", or "Foucault" currents generated in the aluminium-coil frame, caused by its moving across the permanent magnetic field. Hence the instrument is very "dead-beat"; that is to say, when the current alters, the pointer

at once moves to the corresponding position and remains still, without vibrating to and fro several times before coming to rest.

There is, of course, no "magnetic lag" in this class of instrument (*vide* p. 19). The moment of the force on the moving coil for about 85° , the full-scale deflection, is about 1.0 gramme centimetre, or rather less. Fig. 119 shows a perspective view of the interior of one of these Weston instruments. Part of one magnet limb *N*, pole-piece *w*, plate *r*, and bracket *b* is cut away to show the moving coil, springs, and keeper *K* more clearly. Fig. 120 shows the general appearance of a complete instrument—in this case a voltmeter. The pointer is at zero, and the "index" arm, which is turned by the milled head seen just under the tablet marked "Patented", is resting opposite 110 on the scale. In this case the normal working pressure would be 110 volts, so that when the pointer lines up with the index the attendant knows that the voltage is correct without looking at the scale. The arrangement has the further advantage that indications can be seen at a longer distance from

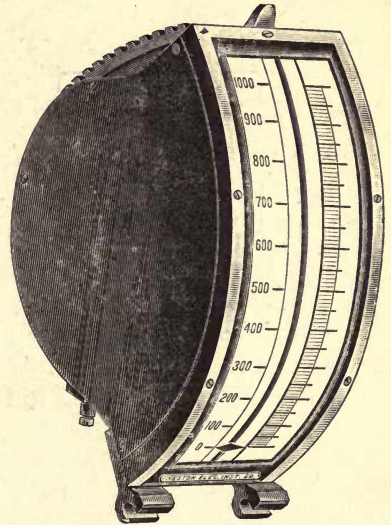

Fig. 121.—Weston Permanent-Magnet Ammeter (Edgewise pattern)

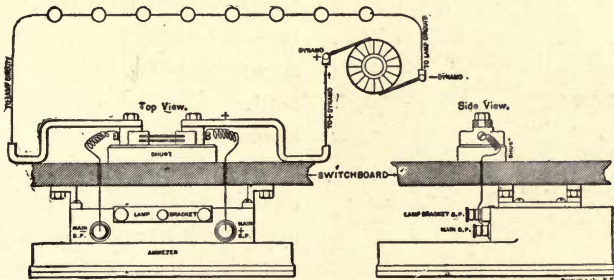

Fig. 122.—Weston Shunt Ammeter on Switch-Board

the instrument than can the exact position of the pointer on the scale. Fig. 121 shows an "edgewise type" of Weston instrument, having, of course, the same uniform scale. The pointer is shown at zero at the bottom of the scale, and rises when the

current flows. It will be seen that though this type has a long scale it is narrow, and consequently a number of them side by side

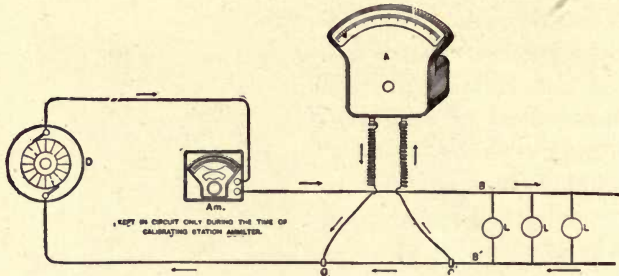

Fig. 123.—Method of Standardizing Weston Ammeter

on a switch-board take up comparatively little room. This is one of the main reasons for the introduction of this form.

The AMMETERS belonging to the class of moving-coil instrument,

measure current indirectly by indicating the fall of potential down a low-resistance "shunt", or strip, placed in the main circuit and carrying the current to be measured, this fall being, of course, directly \propto to the current for a fixed resistance. The shunt is placed in the back of the instrument when the range is not over 75 amperes, but is separate when above this current. The appearance of an ammeter is precisely similar to that of the voltmeter in fig. 120, except that the scale is graduated in amperes directly. The working parts are enclosed in a dust-proof iron case, which also protects them from external magnetic fields.

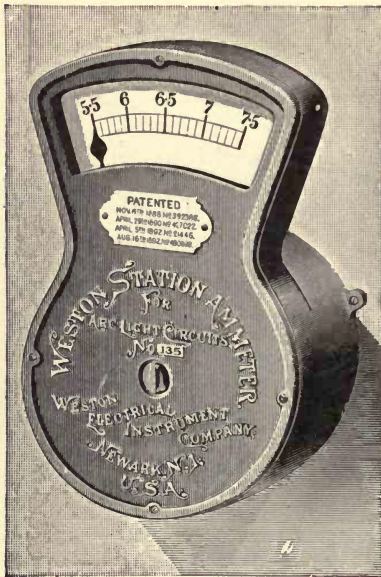

Fig. 124.—Weston Arc-Lamp Ammeter (Sector pattern)

Fig. 122 shows the arrangement of a shunted ammeter on a switch-board and the circuit connections.

Fig. 123 shows an illuminated-dial ammeter A shunted to a

length of the working copper main between the points 0 and 0' and the standard ammeter Am., by means of the indications of which the length of main shunted is found by trial, so that the ammeter A reads correctly. This operation has only to be done once for all at the outset.

Fig. 124 shows the general view of a "sector"-shaped arc-lamp circuit ammeter. The moving coil is controlled so that it does not begin to read until the lower limit of current is reached. Small increments are then magnified by a long open scale up to the maximum, thus enabling the current between the usual working limits to be obtained accurately.

One of the low-resistance shunts, or strips, for use with a Weston potential measurer intended for current measurements, is shown in fig. 125. The instrument combined with this would be calibrated in amperes, and the maximum scale deflection of the pointer would measure 1000 amperes. The shunt illustrated consists of five short plates of a suitable alloy, having a low temperature variation of resistance. These are sweated or soldered into saw-cuts made in two massive copper blocks, to which the clamping bolts and potential screws are attached. Of the potential screws, only the bottom one can be seen. The thickness of the plates is arranged to give the requisite carrying capacity without much heating.

A laboratory form of Weston voltmeter, having a double scale for two distinct sensibilities, is shown in fig. 126. The little button or push, seen just above the right-hand terminal (marked +), is merely a spring key for completing the voltmeter circuit at pleasure when a reading is desired.

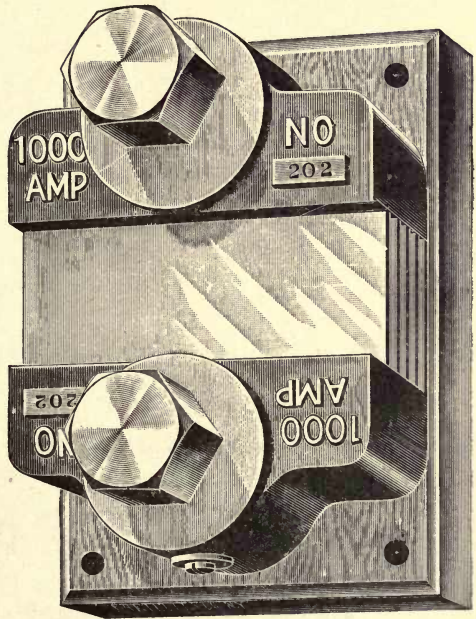

Fig. 125.—Weston 1000 Amp Low-Resistance Shunt for Ammeter

This + terminal is common to both sensibilities, which merely differ by the extra separate resistance placed in series with the same moving coil.

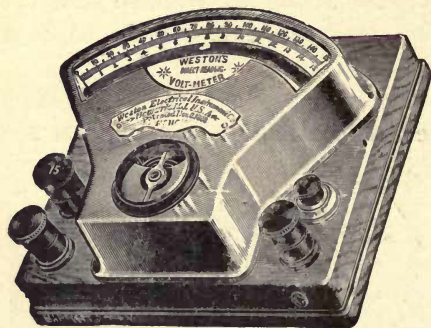

Fig. 126.—Weston Laboratory Type Moving-Coil Voltmeter

The left-hand terminal marked 15, together with the common right-hand one, constitute the pair pertaining to the inner 15-volt scale, while the terminal next to that marked 150 with the “common” one pertain to the outer or 150-volt scale. The dark-looking band inside the inner scale is a strip of looking-

glass, which is for the purpose of preventing parallax when observing the readings of the pointer.

Hartmann & Braun's Moving-Coil Ammeters and Voltmeters

These instruments, supplied by Messrs. O. Berend & Co., work on the same principle as the D'Arsonval galvanometer, have a spring control, and are dead-beat.

Fig. 127 shows a perspective view of the working parts. It will be noticed that the moving coil, wound with many turns of fine silk-covered copper wire, is pivoted inside a brass tube (shown cut away at the right-hand side), carried by the front brass disc. This tube just slips in between the two soft-iron pole-pieces fixed to the limbs of the powerful permanent Ω -shaped magnet. The cross-bar carries the front jewel, and the end of the tube the back one, and the pointer is fixed to the spindle, which carries the coil between the two hair-springs. These are both at the front end, and serve to lead the current into and out of the moving coil, while at the same time controlling its motion.

The damping or dead-beat action of the moving spindle is due to the retarding effect of the Foucault currents induced in the metallic frame on which the moving coil is wound.

The magnetic field due to the permanent magnet is concentrated and directed through the interior of the rectangular moving coil by a soft-iron cylinder, fixed inside the coil, and concentric with the

containing tube. Owing to the powerful field set up between the poles, and to the short distance which the magnetic lines travel in air between pole-piece and keeper, the readings of these instruments

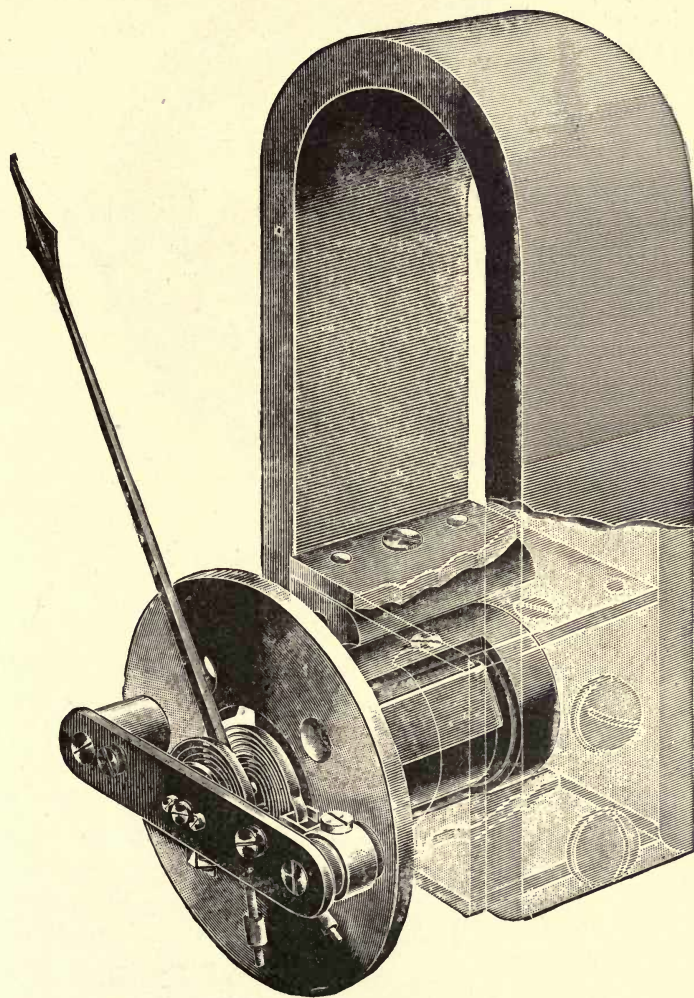

Fig. 127.—Hartmann & Braun Permanent-Magnet Instrument

are practically unaffected by external magnetic fields, while to still further ensure this the whole is iron-cased.

This type of instrument is essentially a potential measurer, and when used for this purpose alone, the moving coil is placed in series with a high resistance across the terminals of the instrument.

It can also be employed to measure currents by shunting the moving coil by a low-resistance strip, and for currents above 100

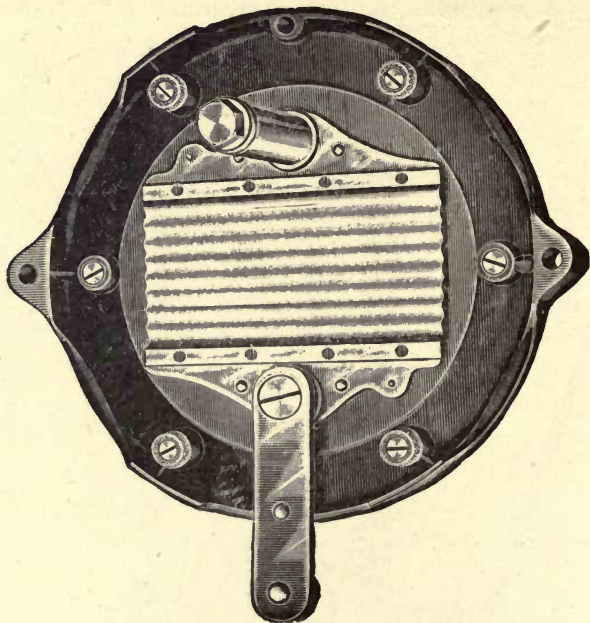

Fig. 128.—Hartmann & Braun Permanent-Magnet Instrument (view of back)

amperes this strip is not placed inside the instrument as indicated in fig. 128, which shows a corrugated sheet or shunt in the back of an instrument, and the method of connection by front or back connecting lugs. Both ammeters and voltmeters have perfectly uniform scales, with equal divisions from 0 to the maximum. They are, however, only available for use with direct currents.

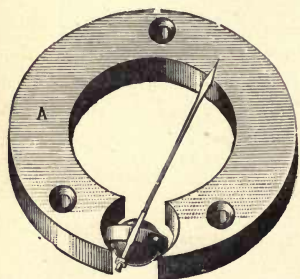

Fig. 129.—Principle of "Victory" Permanent-Magnet Instruments

The "Victory" Moving-Coil Ammeters and Voltmeters

These instruments, supplied by Messrs. H. M. Salmony & Co., of London, are of the permanent-magnet type, have a spring control, and are dead-beat. Their construction will be understood by a reference to figs. 129 and 130. A coil, con-

sisting of a number of turns of fine insulated copper wire, is placed between two concentric rings of sheet or band copper of high conductivity, but is insulated from them. This coil and band is carried by two pivots, in alignment, and running in jewelled centres, and is controlled by two phosphor-bronze hair-springs *s*, which serve to lead the very small current into and out of the moving fine-wire coil. The pointer is attached to the coil and moves with it. The whole arrangement is fitted in a tube, with the front opening shown at one side, fig. 130, and this is capable of just slipping in between the poles of a powerful circular permanent magnet *A*, fig. 129, made of specially-hardened and well-aged magnetic steel.

A ball *F* of the softest iron obtainable is fixed inside but not touching the moving coil, and this not only directs the magnetic field through the coil but considerably augments it, thus making the

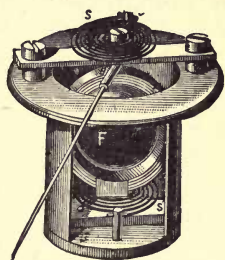

Fig. 130.—Moving-Coil System of "Victory" Permanent-Magnet Instrument

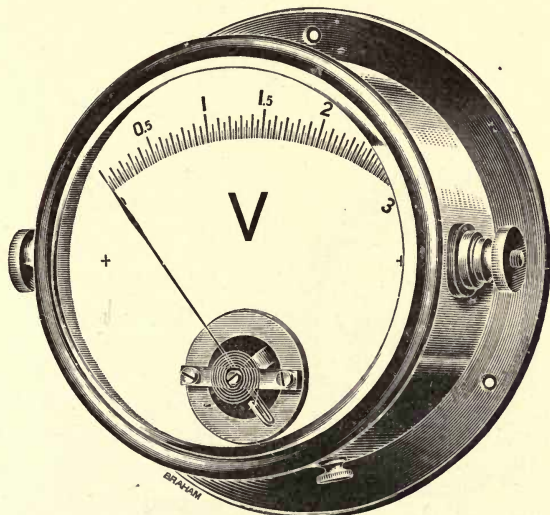

Fig. 131.—"Victory" Permanent-Magnet Voltmeter

instrument more sensitive. The action arises from a current passing through the fine-wire pivoted coil, causing it to deflect through a certain angle against the torsion of the springs. The dead-beat action is caused by the induced current generated in

the copper rings as they move with the coil in the powerful fixed field due to A. These instruments have uniform scales of equal divisions throughout, and when used for measuring higher voltages have a separate high resistance, usually of several thousand ohms,

connected in series with the moving coil. Fig. 131 shows the general form of a Victory type voltmeter, and one edge of the moving coil can just be seen.

These instruments are made into ammeters by shunting them to a low-resistance strip, which carries the main current. Such a combination is shown in fig. 132, which represents an ammeter graduated for 120 amperes joined to the low-resistance shunt seen to the right. The main circuit is connected to the two pairs of bolts seen at either end. This shunt is for 100 amperes, and has a resistance of 400 microhms.

Fig. 132.—“Victory” Permanent-Magnet Ammeter

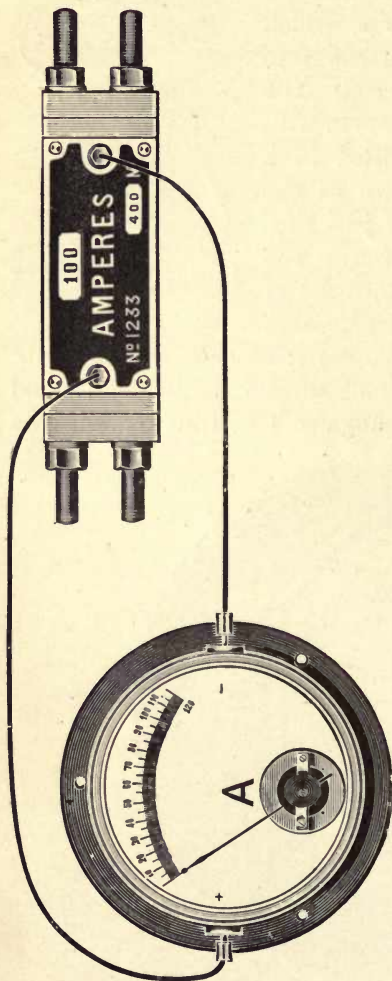

not work with direct currents. They depend for their action on the electro-magnetic screening effect of eddy currents, the torque causing the deflection being produced by the mutual action of eddy currents in a light metallic pivoted disc, and in a metallic screen which partially shields the disc from the magnetic action.

Alternating-Current Induction Ammeters and Voltmeters

These instruments, made by the Electrical Co., London, are applicable solely to the measurement of alternating current and pressure, and will

Fig. 133 shows in plan and side elevation the principle on which these instruments work, and fig. 134 the actual construc-

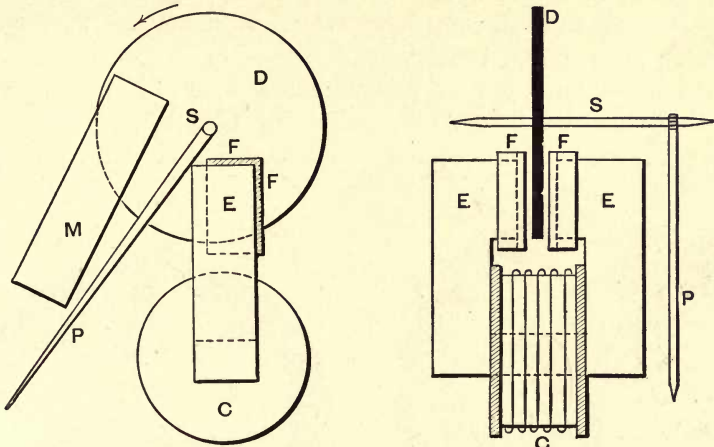

Fig. 133.—Principle of Electrical Company's Induction Instruments,

tion of a finished instrument in front and side elevations. They consist of a working magnetizing coil C, which energizes a well-laminated magnetic circuit having pole-pieces E, also well-laminated,

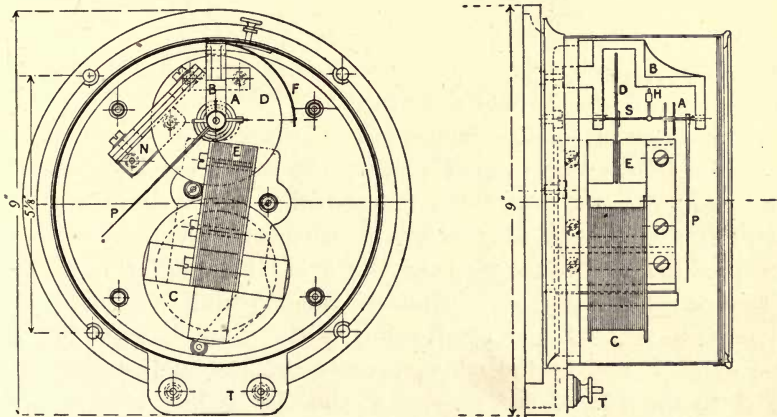

Fig. 134.—Interior of Electrical Company's Induction Instruments (side and front elevations)

ated, and separated only by a narrow air-gap. In this gap between the poles E is a metal disc D, mounted on a horizontal spindle S, pivoted in jewelled centres, and carrying the pointer P and balance-
H

weight *H* (fig. 134). *B* is the supporting bracket that carries the spindle *s* and its attachments.

Covering the greater part of each pole face *E*, and bent back so as to cover the top and right-hand side of each, are the fixed metal screening-plates *F* (fig. 133).

The movable disc *D* is further acted upon by the separate permanent magnet *M* (fig. 133) and *N* (fig. 134), between the poles of which *D* rotates. Eddy or Foucault currents are thus produced

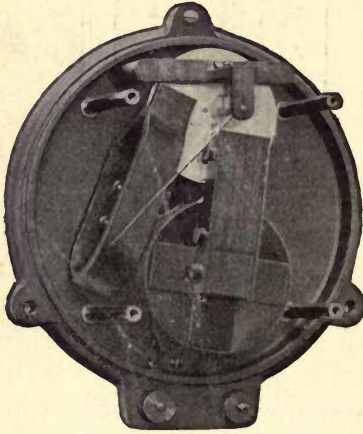

Fig. 135.—Internal View of Induction Ammeter
(Scale and Case removed)



Fig. 136.—Induction Voltmeter

in the disc, thereby giving the necessary damping for making the movements of the spindle *s* dead-beat.

The action of the instrument is as follows:—The lines of force, emanating from one magnet pole to the other, partially cut the stationary screens *F* and the movable disc *D* (to the left of the screens) and induce eddy currents in them. As these currents are produced by the same magnetic field, they flow in the same direction. But by the well-known fundamental law in electro-dynamics—parallel currents flowing in the same direction attract one another, and as the eddy currents induced in *D* are induced in it to the left of the screens *F*, the disc *D* has exerted upon it a torque in the direction of the arrow fig. 133, owing to the attraction between the induced eddy currents in *D* and *F*. Fig. 135 shows the internal view of an induction ammeter, and fig. 136 the general view of a voltmeter, from which the kind of scale graduation obtained with these instruments is clearly seen.

For voltmeters between 500 and 1000 volts the coil of the instrument is in series with a choking coil placed outside the voltmeter, and corresponding to the extra high resistance in the moving-coil direct-current voltmeter, while for higher pressures a "voltage transformer" is employed, and the instrument connected to the

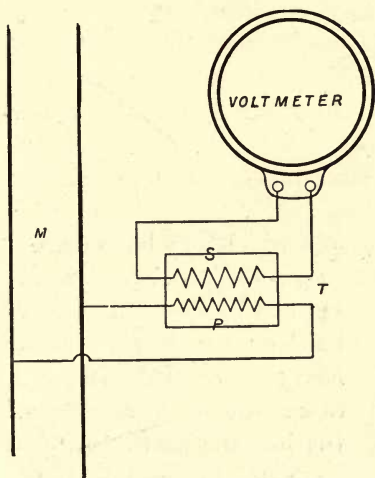

Fig. 137.—Method of connecting Low-pressure Voltmeter to High-pressure Mains

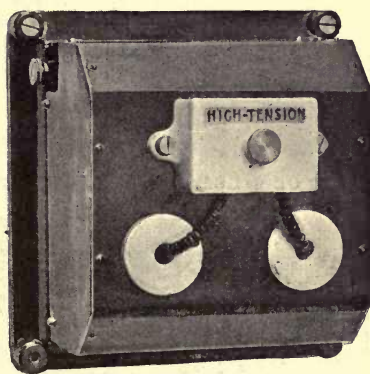

Fig. 138.—High-pressure Transformer

secondary, which is at about 100 volts pressure, the primary being at the high potential of the line.

The connection of this voltmeter to the high-pressure mains through the voltage transformer is shown in fig. 137, and the

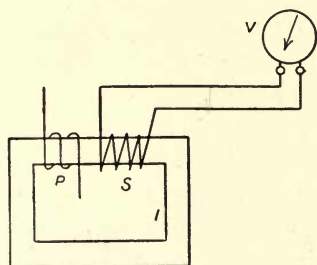

Fig. 139.—Principle of Current Transformer

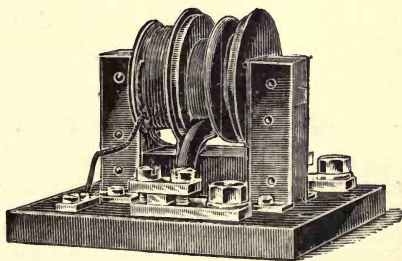

Fig. 140.—Current Transformer for 250 Amps.

transformer itself in fig. 138, which indicates the general appearance of it.

In the case of ammeters for measuring current in high-tension circuits, a current transformer is used with an ordinary low-tension ammeter of this induction type, as shown diagrammatically in

fig. 139. In this way, no current at high tension is led into or out of the measuring instrument.

An actual current transformer for currents up to 250 amperes is shown in fig. 140, and one for 600 amperes in fig. 141. The coil which is connected with the high-tension circuit, and which is seen in fig. 140, consisting of a single convolution, is very highly insulated.

The secondary winding leading to the ammeter has only a few volts pressure across its terminals, but sufficient to enable the instrument to be placed some considerable distance from the current transformer and the high-tension mains.

The application of current transformers, which may be immersed in oil or otherwise, is not restricted to high-tension circuits alone,

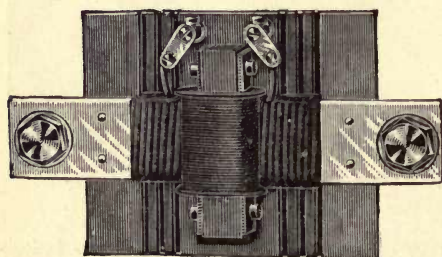

Fig. 141.—Current Transformer for 600 Amps

but can be used with a low-tension net-work taking heavy currents. In such cases the copper coils of the instrument itself would have to be made of the same sectional area as the mains, necessitating a very large increase in the size of the instrument.

By the employment of a current transformer, however, placed in the main circuit, only two small wires need be taken to the ammeter, as shown in fig. 142, which represents an induction ammeter with current transformer for 3000 amperes. The application of current transformers possesses an additional advantage, for by means of a multiple-way switch an operator can, with one and the same instrument, compare the currents in different branch circuits, without interrupting the currents flowing in them.

This is the case with three-phase currents, when it is often requisite to be able to accurately compare the currents in the different circuits.

The common arrangement is to use two or three ammeters, which has the obvious disadvantage that the instruments do not always agree in their indications. Fig. 143 indicates the connections for the comparison of two-current circuits, in each of which is a current transformer, the secondary windings of which are connected to the ammeter by means of a two-way voltmeter switch.

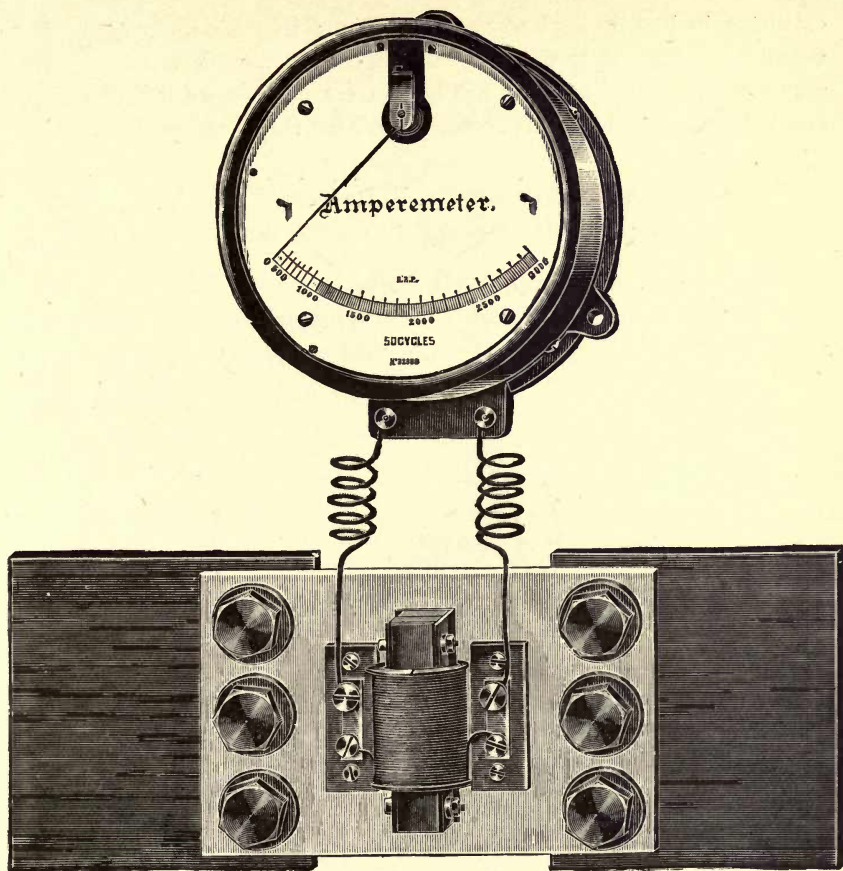

Fig. 142.—Ammeter for 3000 Amps Shunt to Current Transformer

These induction instruments possess the advantage that their readings are less affected by the wave form of the alternating current than the electro-magnetic moving-needle instruments, the principle of which depends on a piece of iron being either attracted or repelled by the magnetic field due to the main-current coil. The

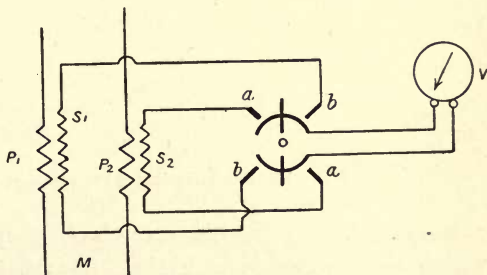

Fig. 143.—Method of Measuring Currents in different Mains with one Ammeter

ammeter is less dependent on fluctuations in periodicity than the voltmeter. This does not play an important part, however, as the majority of central stations are built for a certain fixed frequency, and these instruments can be calibrated for this fixed periodicity.

Ferraris Induction Ammeters, Voltmeters, and Wattmeters (For Alternating Currents only)

These instruments, supplied by Messrs. Siemens Bros. & Co., of London, are essentially intended for the measurement of single and polyphase alternating currents only, and will not work with direct

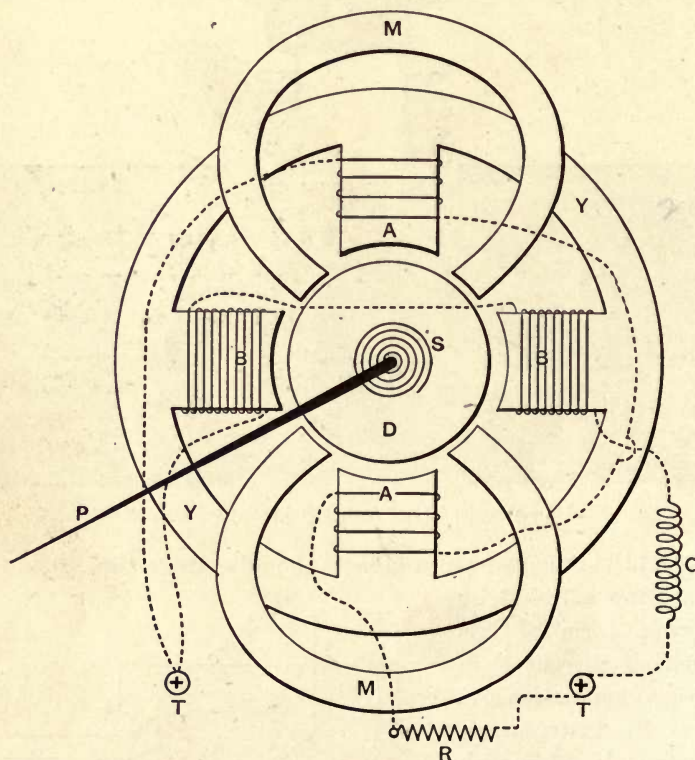

Fig. 144.—Principle of Ferraris Induction Voltmeter

currents. The principle on which they are constructed and on which they work is a distinct departure from that of the usual types of measuring instruments, and is both simple and conducive to the accuracy of the readings.

A sketch of a voltmeter of this type is shown in fig. 144, by a reference to which the general principle of these instruments, which is simply that of a Ferraris induction motor, will be understood.

They consist of a light aluminium drum *D* mounted on a horizontal spindle, pivoted in jewelled centres. To the drum is attached the pointer *P*.

The angular motion of the drum *D* is constrained by a pair of light hair-springs *S*, and its motion made aperiodic by the two powerful permanent steel magnets *M* inducing local eddy or Foucault currents in the drum which retard its motion.

The drum is acted on by a rotating magnetic field produced by four poles *AA* and *BB* surrounding it. One opposite pair of these poles *AA* is energized by the current to be measured, and the other pair by a shunt current which is displaced in phase from the main current by means of a choking coil *C* in series with *BB*.

These main and shunt coils are in parallel between the two terminals *T* and *T* of the instrument, and the main-coil branch has a non-inductive resistance *R* in series with it, which in the case of an ammeter is a low resistance, when the choking coil *C* is not used owing to the coils themselves having sufficient inductance in an ammeter.

In this form also of the instrument, except for quite low ranges, a current transformer is used, so that it is unnecessary to bring heavy current conductors to the instrument, small leads only being required, as in the case of shunts with direct-current ammeters.

With voltmeters of this type a transformer is used for the higher ranges to reduce the voltage at the instrument to some 110 volts. Wattmeters for the higher ranges are used with a choking coil in the volt circuit, and a transformer in the current circuit.

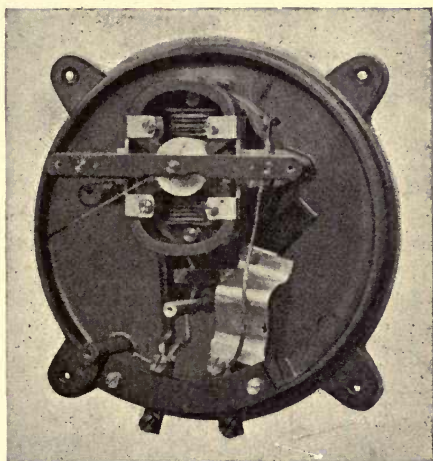

Fig. 145.—Interior of Ferraris Induction Ammeter

A view of an ammeter with case and scale removed is shown in fig. 145, the white band or strip of metal in the right-hand bottom corner being the non-inductive low resistance in series with the main coil.

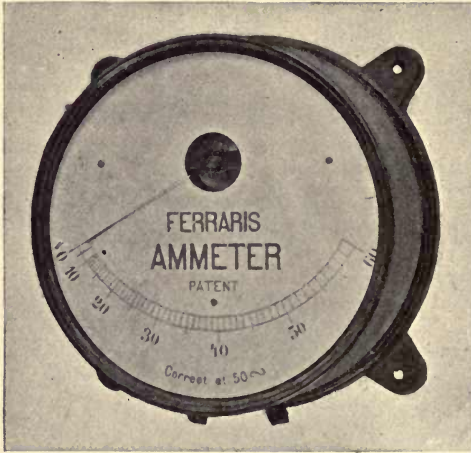

Fig. 146.—Ferraris Induction Ammeter

A view of this instrument, with scale and case in position, is shown in fig. 146, from which the scale will be seen.

This, it will be noticed, is tolerably long, open, and uniform.

These instruments are practically unaffected by external magnetic fields, as the moving part is non-magnetic; and further, a variation of 10 per cent in the frequency of the supply being measured will not affect the accuracy of the readings.

as the moving part is non-magnetic; and further, a variation of 10 per cent in the frequency of the supply being measured

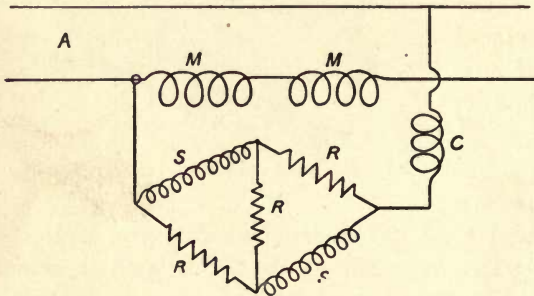

Fig. 147.—Connections of Coils and Resistances for Ferraris Induction Wattmeter

The connections of the coils and non-inductive resistances in the case of a wattmeter are shown in fig. 147, in which MM are the two main coils, SS the two shunt

coils, C the choking coil, and RRR the non-inductive resistances.

Westinghouse Induction Ammeters and Voltmeters

These instruments, made by the British Westinghouse Electric and Manufacturing Co., are of the induction type, and have a spring control. They are consequently alternating-current instruments, and will not work with continuous currents. They are usually

calibrated for the periodicity of the circuit it is intended to instal them upon, but they read accurately within 25 per cent above or below the periodicity they are standardized at. In principle of action they are closely allied to the Westinghouse integrating watt-meter (p. 288), and their construction will be understood better from a reference to fig. 148, which shows diagrammatically the internal working parts in perspective.

They consist of a thin aluminium ring disc *D*, shaped as shown, and mounted on a horizontal spindle *A A*, pivoted in jewelled centres (not shown). The rim of this disc *D*, as it turns, moves through the narrow air-gap separating the poles *B* and *F* of a well-laminated magnetic circuit *L*, composed out of the softest Swedish charcoal iron, of thin stampings *G*, of the shape shown.

A sufficient number of these are assembled and secured side by side.

Over the limb or pole *B* is slipped a magnetizing coil *C*, wound with tolerably small gauge insulated copper wire. This coil is connected across the two terminals of the instrument in parallel with a non-inductively-wound resistance, which is also connected across these terminals.

A pin *E*, attached to the edge of *D*, limits the angular play by impinging on flexible stops.

The spindle *A A* carrying the disc is controlled by the phosphor-bronze hair-spring *S*, while the motion of the disc *D* is damped by means of the permanent magnet *M*, between the poles of which *D* moves.

Fig. 149 shows the general appearance of an ampere-meter for measuring alternating currents up to 200 amperes, but the

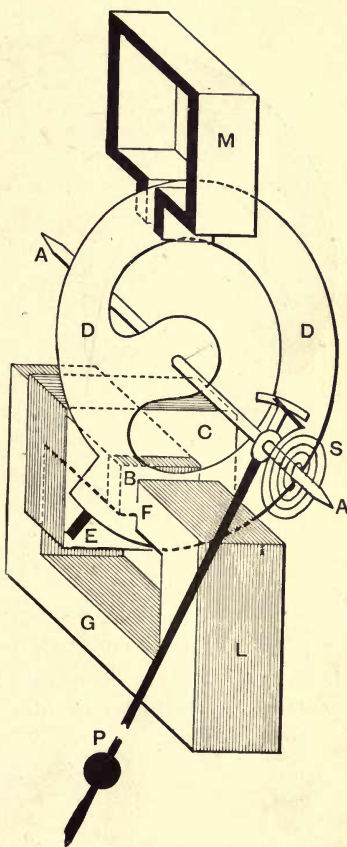

Fig. 148.—Principle of Westinghouse Induction Instruments

voltmeter and wattmeter of this make are precisely similar in appearance.

It will be noticed that they have extremely long scales, subtending an arc of about 300° , and are similar in this respect to the author's instruments (pp. 72-74).

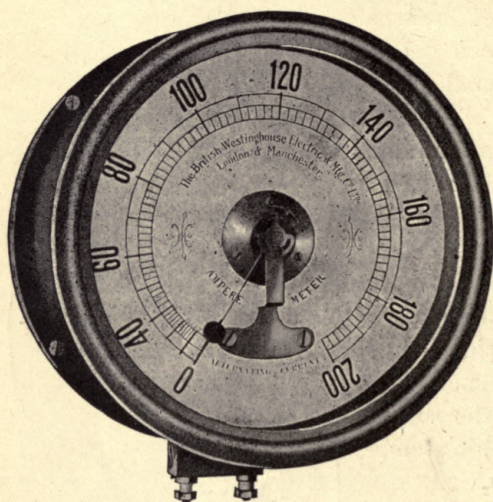

Fig. 149.—Westinghouse Induction Ammeter

Owing to the length of scale, the divisions are long, open, and distinct, thus allowing readings to be made with ease and accuracy.

With all ammeters of greater capacity than 5 amperes, series transformers are used, which are separate from the ammeter. For capacities of 800 amperes and above, these transformers are made to slip over a cable or 'bus

bar. The use of series transformers allows the instrument to be fixed at any convenient place, and not close to leads carrying heavy currents. [Pressure transformers are used with the voltmeters for voltages of 300 and upwards.]



CHAPTER IV

HOT-WIRE AND ELECTRO-STATIC INSTRUMENTS

It is convenient, for several reasons, to group these two important classes of electrical engineering measuring instruments together.

We will, however, treat of each class separately in respect to the general considerations pertaining to the instruments forming it.

Hot-Wire Instruments.—In these the heating effect of the current is made use of for indicating the current or pressure to be measured.

It is a well-known fact that the linear expansion or elongation of a wire when heated is \propto to the rise of temperature (T° C. say) \times coefficient of linear expansion (a) for the material of which the wire is made.

The coefficient a is defined as the extension of a body of unit length between 0° C. and 1° C., and is a constant within certain limits of temperature. Hence we have the rule that the

elongation of a wire is \propto the rise of temperature T° C.

When a current of c amperes flows through a wire of R ohms resistance, the number of heat-units H developed in the wire per second is $\propto c^2 R \propto EC$, where $c = \frac{E}{R}$ and E is the potential difference across R .

But 1 ampere flowing through 1 ohm generates 0.24 heat-unit per second, where this heat-unit is the amount of heat required to raise 1 gram of water through 1° C.

Hence if the current c flows through R ohms for t seconds, the total number of heat-units generated $H = 0.24 c^2 R t = 0.24 E c t$. If s = the specific heat of the material of the wire, which may be defined as the quantity of heat absorbed by it for a given rise of temperature, compared with the quantity of heat absorbed by

an equal mass of water when raised through the same range, and if w = weight of wire in grams,

$$\text{then } T^\circ = 0.24 \frac{E C t}{w.S} = 0.24 \frac{C^2 R t}{w.S},$$

$$\text{whence } T^\circ = (\text{a constant}) \times E C,$$

$$\text{i.e. } T \propto E C,$$

where t may be taken as unity, and both w and S are constants for the given wire.

But if the resistance of the wire R remains constant,

$$\text{then } c \text{ varies directly as } E,$$

consequently the expansion $\propto T \propto E \propto C$.

Thus the principle can be utilized for measuring both current and E.M.F., and a material is chosen for the wire which has an extremely small temperature coefficient. By this means R remains fairly constant, and therefore only the expansion of the wire has to be measured.

Hot-wire instruments have the great advantage that they will measure accurately, direct, as well as alternating, currents of any "frequency" or "wave form".

They are absolutely free from temperature errors, as the heating effect is made use of in the actual measurement.

They are dead-beat, direct-reading, and absolutely unaffected by external magnetic fields.

Their disadvantages are: that they absorb a good deal of energy, and will not indicate voltages lower than about one-fifth of the maximum.

Electro-Static Instruments.—These are employed for measuring E.M.F.'s and depend for their action on the electro-static attraction and repulsion between fixed and movable conductors close to, but insulated from, one another.

Owing to the small forces acting, the control is usually gravity, but in some cases that due to the torsion of a wire or spring is employed.

This type of instrument possesses the great advantage of being non-magnetic, and therefore entirely unaffected by external magnetic fields.

It is equally accurate on direct and on alternating current circuits of any periodicity or wave form, as it has no self-induction, but, on the contrary, an extremely small capacity. It has no

temperature error, and consumes no energy at all, as the terminal resistance is practically infinitely large.

The disadvantage lies in the fact that low voltages are not easily or clearly indicated, and that the scales of such instruments are usually somewhat short and the divisions a little crowded in consequence.

In the present chapter both the hot-wire and the electro-static instruments which are commonly met with in practice, will be described, each being treated separately.

Cardew Hot-Wire Voltmeter

This well-known instrument, invented by Major Cardew, and made by more than one manufacturer, is very simple in principle and action, though somewhat delicate in its mechanism. Its action depends on, and is governed by, the linear expansion of a fine metallic wire, caused by the heat generated in it due to the passage of an electric current through the wire.

The theory of the measurement of potential difference by hot-wire instruments will be found on p. 123, *et seq.* Suffice it here to say, that a measure of the elongation of the wire by heat forms a measure of the potential difference applied to its extremities, which can therefore be obtained.

The construction of a Cardew voltmeter, by which the indication of this elongation is obtained, and in which the many possible sources of error are practically eliminated, is shown in figs. 150 and 151.

It consists of a circular brass case, the sides of which carry the terminals of the instrument, the cover in fig. 151 being removed to show the interior from the back. The circular scale is at the other side of the case. To the lower part of this case is fixed a plate of brass, with an aperture in its centre; this plate carries two metal rods, which at their lower ends support a ring of metal to which is fixed a frame. In the frame is pivoted a spindle oo which runs in jewelled centres and carries, but is insulated from, two light metal grooved pulleys, M and N , shown in fig. 150. T_1 and T_2 are two fixed brass blocks, of which T_2 is in connection with the right-hand terminal (fig. 151) through a wire, while T_1 is connected to the left-hand terminal through the two spring brass strips and the fuse shown in a slanting position between their ends.

The working wire *w*, which is heated by the current, is made of platinum-silver, 0.0025 inch in diameter, and has one end fixed to the block T_2 . From T_2 it passes down and round the right-hand metal pulley *N* at the bottom, and then returns and passes round a small V-grooved pulley *Q* of bone or vulcanized fibre; it then passes down and round the other metal pulley *M* at the bottom, and finally up to the brass block T_1 to which it is attached.

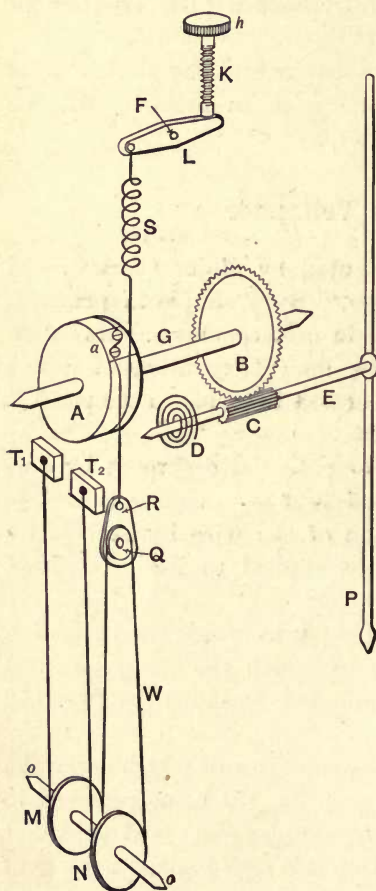

Fig. 150.—Principle of Ordinary Cardew Voltmeter

Although the use of working wires of different diameters is theoretically the most perfect means for obtaining different ranges in the Cardew voltmeters, experience has conclusively shown that wire of less than 0.0025 inch diameter is unable to stand the rough usage to which a voltmeter is at times subjected. Hence this size has been fixed on as a regular one for use as the working wire.

Platinum-silver has been chosen as the material because of its lower variation of resistance with temperature and high specific resistance.

The terminals are insulated from the case by bushes and washers of insulating material, usually vulcanized fibre, and the blocks T_1 and T_2 from one another and from the case by being fixed to a block of insulating material

which is itself screwed to the brass base plate.

The working wire is strung in such a way that the elongation causes both metal grooved pulleys at the bottom of the rods to rotate in the same direction (as shown in fig. 150), thus minimizing the effect of friction at the pivots. The rods and wire are protected from injury by a long brass tube (not shown in fig. 150) outside.

The little grooved button *Q*, round which the working wire passes, does not literally act as a pulley after the wire is strung, since any elongation has no effect in causing it to rotate. It is mounted on the lower end of a thin light brass strip *R* by a small screw passing loosely through its centre into *R*.

To the upper end of *R* is attached another thin platinum-silver wire which passes up and once round a specially-grooved metal pulley *A*, and thence passes up and is attached to the lower end of a German-silver helical spring *s*. The upper end of this is fixed to one end of a lever *L* pivoted about a fulcrum *F*, and capable of being tilted by the tension-adjusting screw *K*. This can be screwed up or down by turning its milled head *h* at the top of the instrument case.

The function of *s*, which is at the outset in tension, is to immediately take up any slack or elongation of the working wire

due to it being heated by the passage of current. Experience has shown that a spring of the form shown at *s*, and made of German silver, exerts a fairly constant tension on the working wire over long periods of use. Any variation in the tension, such as would have the effect of altering the zero position of the pointer of the voltmeter, can be corrected by slightly turning the screw *hK*, and so bringing the pointer back to zero for no current through the instrument. It will now be noticed that on the passage of the current *Q* and *R* will move upwards by an amount equal to the expansion of *two* lengths only of the heated wire, namely, either those between *Q* and τ_1 or *Q* and τ_2 . In this way *s* may be allowed to exert a greater force, since it pulls at two wires together instead of one. Hence, by measuring the distance through which *R* moves, we shall

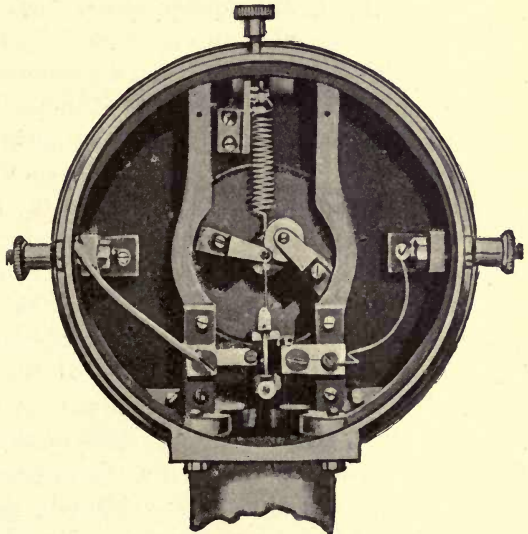

Fig. 151.—Interior of Cardew Voltmeter from the Back (cover removed)

have a measure of the expansion of the working wire, and consequently of the potential difference applied to it, and which causes its expansion. Further, since this distance is small, it will have to be magnified by some multiplying arrangement, which must be as frictionless as possible owing to the force producing the motion being so small.

The pulley A is fixed to a light spindle G, running in jewelled centres, which also carries a toothed wheel B.

This wheel B in turn gears into a small pinion C mounted, together with a light hair-spring D and the pointer P, on a second spindle E parallel to the first, and also running in jewelled centres. It will now be seen that since the diameter of the toothed wheel B is much larger than that of the geared pinion C, this latter with its spindle and attached pointer may make nearly one revolution for a small angular motion of A caused by the small expansion of the working wire, the diameters of A and B being about the same.

The teeth of the pinion and wheel B are carefully made to fit; but obviously they cannot be fitted so closely and tightly as to avoid "play" or "back-lash" between the teeth, owing to the friction that would thus result. To avoid the errors that would be caused by this, the fine hair-spring D, seen in fig. 150, is inserted, which always maintains a very light pressure of the teeth of the pinion against those of B in the *same direction* or *sense*. This ensures that the pinion moves absolutely simultaneously with the driving toothed wheel B in whichever direction this latter turns.

A difficulty in early forms of Cardew voltmeters arose with regard to the fine wire and pulley A round which it passes, for it will be obvious that this wire must pass round A without any slipping and without causing friction. This difficulty has been got over in the way indicated in fig. 150. The pulley A has two narrow parallel grooves in its circumference side by side, and a flat *a* is filed at one part of the edge in which two small set-screws are inserted. The wire *w* is led from R, as seen in fig. 150, partly round one groove across the flat *a* round the heads of the set-screws, and round the other groove up to S.

Thus, although the wire is not clamped under the head of either set-screw, which it would not bear, it is unable to slip past the screws. The arrangement is quite satisfactory, since the pulley A only turns through a small angle.

It may be asked why the expansion of two lengths only of the

working wire, instead of the whole, should be used in indicating the potential difference applied. It will, of course, be at once obvious that since the current passes through the four lengths in series, the heating of each is the same, and therefore the total expansion four times that of one. A little consideration will, however, make it clear, that while in the latter case twice as much indication or motion of R would result if it were at one end of the working wire, by having it as shown the tension or force due to S is equally distributed between both wires running from Q, which might in a sense, and but for convenience in wiring, be fixed to Q. Thus a greater tension can be exerted by S, causing A to be turned by twice the force, thereby minimizing friction and obviating the necessity for the use of a thicker working wire to stand the tension. A safety fuse is shown on the left-hand side of the mechanism, fig. 151, and consists of a short length of platinum-silver wire, 0.0014 inch in diameter, laid in a protecting groove in a short length of rectangular vulcanized-fibre rod terminated by brass caps at each end, to which this fine fuse wire is clamped, and which therefore form its terminals.

This fuse is slipped into the two spring-brass clips seen in connection with the left-hand terminal and the brass block T_1 . Hence the insertion of a new fuse is only the work of a very short time. It should be carefully noted that this fuse, though finer than the working wire, will only protect this latter in cases where the E.M.F. either rises gradually or, if applied suddenly, does not exceed by 100 per cent the highest scale reading.

The sudden self-inductive rise of E.M.F. consequent on lifting the brushes, or in any other way breaking the field circuit of a dynamo to which the voltmeter is connected, will probably melt both fuse and working wire. Again, if, while the voltmeter is connected to the low-tension terminals of a transformer, the insulation breaks down, the fuse will be powerless against the sudden application of the high E.M.F. of the primary.

With the exception of the two rods not shown, but which support the centres of the spindle oo , the outer enclosing case of this voltmeter is of brass.

These rods, however, cannot be made of brass or iron owing to the coefficient of expansion of these metals being respectively greater and less than that of the platinum-silver working wire. This would cause the rods to expand with changes of temperature,

atmospheric or otherwise, to a greater and less extent than the wire, and so cause a deflection of the pointer even when no current was flowing. As this would cause serious errors, the rods are made partly of brass and iron, as platinum-silver would be too costly. The lengths of these metals forming the rods are so proportioned that the greater expansion or contraction of the brass counteracts the less expansion or contraction of the iron, thereby causing the rods to have the same coefficient of expansion as the wire itself.

Fig. 152.—Extra Resistance for use with Cardew Voltmeter

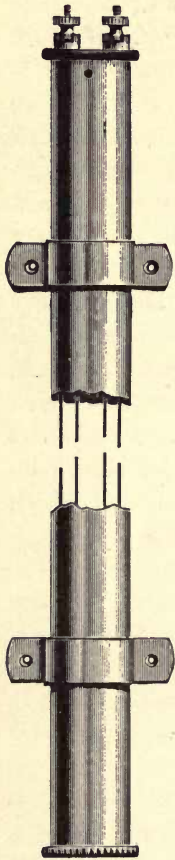

Fig. 151 illustrates what is called the rod-pattern Cardew voltmeter, the rods and working wire being encased in a brass protecting tube (fig. 154) which can easily be removed to allow access to the wire for restringing when necessary. This rod pattern is usually used in a vertical position, but in such a position the oscillations of the pointer, caused by the heated air inside being displaced by colder air rising, and thus causing air currents, limit the accuracy of observation to from $\frac{1}{2}$ to 1 volt over the whole scale. This oscillation is entirely absent when the instrument is used horizontally, for the wire then lies in a more uniformly heated space, and the air currents are feebler and more uniformly distributed; but in this position the friction is greater,

and the gain in accuracy is so small that in the 150-volt instrument the advantages are, on the whole, on the side of the vertical pattern.

At the high readings the rod pattern reads about $\frac{1}{2}$ per cent too low, if left continuously in circuit, owing to the temperature rise.

Another pattern is made in which the rods are dispensed with, and the tube, which is now compensated, used instead. This tube instrument, which is more costly than the rod type, is used horizon-

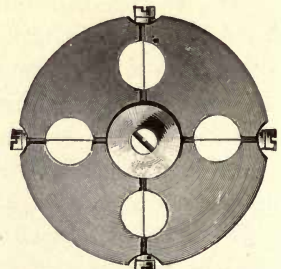

Fig. 153.—Fuse for Cardew Voltmeter

tally only, and reads accurately under all conditions of working at any ordinary temperature. The pulleys are now carried by, and fixed to, the end of the tube itself, and this makes it much more difficult to re-wire the tube form than the rod type of instrument.

Since the heating effect of the current affords a measure of the E.M.F., the *heating error* common to all but electro-static voltmeters is entirely absent here. For similar reasons the instrument is unaffected by external magnetic fields, and as no iron is used in the actuating part, and the wire not coiled, the instrument possesses only an extremely small self-induction. This gives it the enormous advantage of being an accurate measurer of alternating as well as direct current E.M.F.'s.

Cardew voltmeters are constructed to measure up to 120 or 150 volts with only the ordinary working wires, the scale being graduated from 30 volts in the former and 40 in the latter, *i.e.* the graduations commence at a quarter of the full-scale reading. If higher-reading instruments are wanted a resistance-tube has to be used in series with the actual instrument, in accordance with the principle mentioned on p. 14 for making a low-reading voltmeter measure higher voltages.

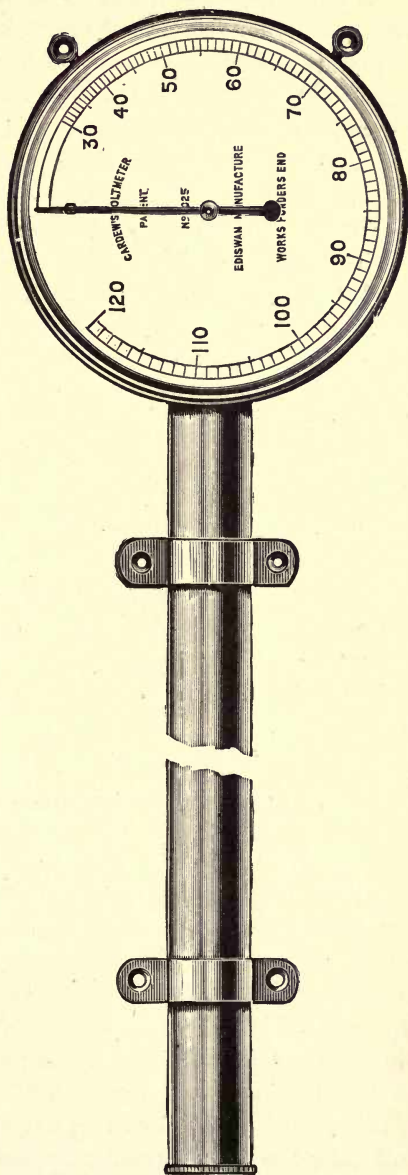

Fig. 154.—Horizontal Pattern Cardew Voltmeter

In the present class of instrument, however, such tube resistances must be constructed so as to be under working conditions precisely similar to those the wire in the instrument itself is under.

Fig. 152 shows the form such an extra series resistance takes, as made by the Edison & Swan Co. It consists of a brass tube of the same size as that fixed on the voltmeter, in which is strung a wire of the same size, resistance, and length as that used in the instrument.

The two terminals of the wire are fixed on the ebonite cap which closes one end of the tube.

If this resistance is connected in series with the voltmeter, then the multiplying factor for all the readings will be 2, since it will now require just twice the E.M.F. at the ends of the combination to give a full-scale deflection.

Fig. 153 shows the fuse which the Edison & Swan Co. fit in all their Cardew voltmeters.

It consists of four fuse wires, which can be placed successively, as they become fused, in series with the working wire of the instrument, by turning the disc which carries them round a quarter of a revolution. Contact is made with each fuse through the heads of the central and side screws touching two springs in the instrument as the fuse block turns.

Fig. 154 illustrates a complete voltmeter, reading from 30 to 120 volts.

Cardew Low-Reading Hot-Wire Voltmeter

It will have already been observed that the hot-wire voltmeters described up to the present cannot be used for determining small E.M.F.'s, though such often require to be measured. The unsuitability arises from the extremely small elongation produced by the small rise of temperature caused when so small an E.M.F. is applied. Major Cardew devised a form of hot-wire voltmeter, illustrated in fig. 155, which is capable of reading either alternating or direct current voltages from 0.5 to 2.5 volts. In an instrument of this nature there must be no friction whatever in the mechanism, and indeed it is this condition which makes the device a possibility. The construction is ingenious, and consists of a platinum-silver wire *www*, 0.0025 inch in diameter, held taut by being attached to the upper ends of two spring bows or strips *BB*, with which it

makes metallic connection. This working wire also passes round the two V-grooved brass studs fixed to the metal bar EE, and round a pin let into a brass nut F, which moves up or down by turning the screw A, thus forming the zero adjustment for the pointer P. This latter is carried or suspended from the tops of BB by the two light springs SS and rigid wires RR, but none of these put the tops

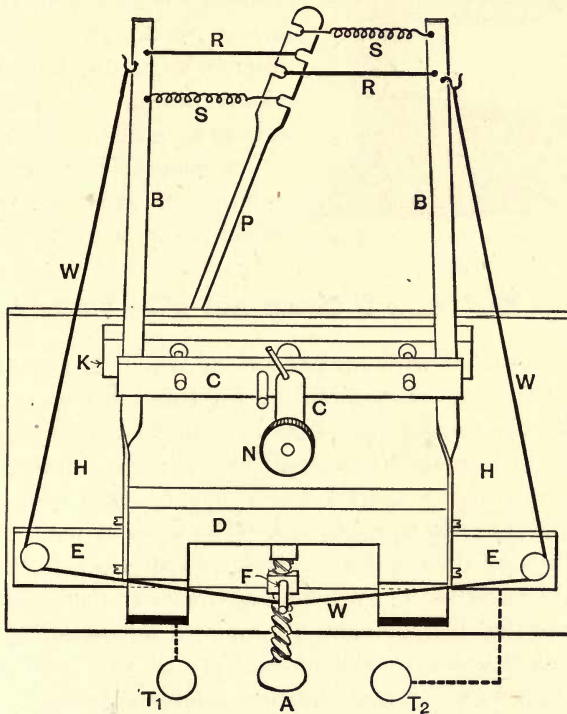

Fig. 155.—Principle of Low-Reading Cardew Voltmeter

of the spring bows BB in electrical connection owing to silk thread being used to tie them to BB.

The bows BB are given a quarter twist at their lower ends, and then fixed to a brass block D by set-screws.

A light bar CC presses BB up against the bar K when the head N is turned once round, thus clamping the bows when the instrument is not in use. The scale plate is shown at H, the scale and lower end of P being on the other side, and therefore invisible in the fig. 155.

The terminals T_1T_2 are connected, one to the brass block D and

the other to the brass bar E, which are insulated from one another.



Fig. 156.—Low-Reading Cardew Voltmeter

Thus, when a pressure is applied to the terminals, the current enters, say, at T_1 , flows up BB and then down WW *via* E to the other terminal T_2 . This causes the working wire WW to expand and allow the upper ends of BB to approach one another, and makes the pointer P move from right to left as seen in the diagram.

A general view of a complete instrument is shown in fig. 156, which reads up to 2.5 volts.

The Hartmann & Braun Hot-Wire Voltmeter ✓

This form of hot-wire instrument, of which Messrs. Johnson & Phillips are the sole manufacturers for this country, is similar in principle to the Cardew hot-wire instruments, in so far that the heating effect of an electric current in a wire of suitable resistance and material is by a special arrangement made to indicate the potential difference to be measured. The form of instrument, however, is a departure from that of Major Cardew's, being much more compact and portable, and not having the somewhat unwieldy tube pertaining to that instrument. In outward appearance these Hartmann & Braun hot-wire instruments are of the ordinary circular central-station "dial" form. From a reference to fig. 157 the construction of these voltmeters will be fairly apparent.

The voltmeter consists of a metal compensation plate K made from a carefully-tested alloy, the temperature coefficient of resistance and expansion of which is the same as that of the working hot wire of the instrument. On this plate K the whole of the mechanism is mounted. The working or hot wire AB, which is made of platinum-silver and about 6.3 inches long, is stretched between a fixed stud B and a tension-adjusting arrangement at A, by means of which it can be kept taut to the same extent should it at any time show a tendency to get slack due to any other cause than the passage of current. At C, near the mid point of AB, is attached another fine wire CF, of phosphor-bronze,

which is held taut at right angles to AB by attachment to a fixed stud F.

Near the middle of the wire CF is attached one end of a fibre of cocoon silk at E, stretched at right angles to CF. This fibre passes round a specially-grooved metal pulley w, and has its other end, which terminates in a small eyelet, attached at H to a flat steel spring s carried by a fixed stud G. The pulley w, together with the pointer P, is carried by a small spindle running in jewelled centres, the front one of which is carried by the frame NL. Behind w is a thin and light aluminium ring-shaped disc D, also rigidly attached

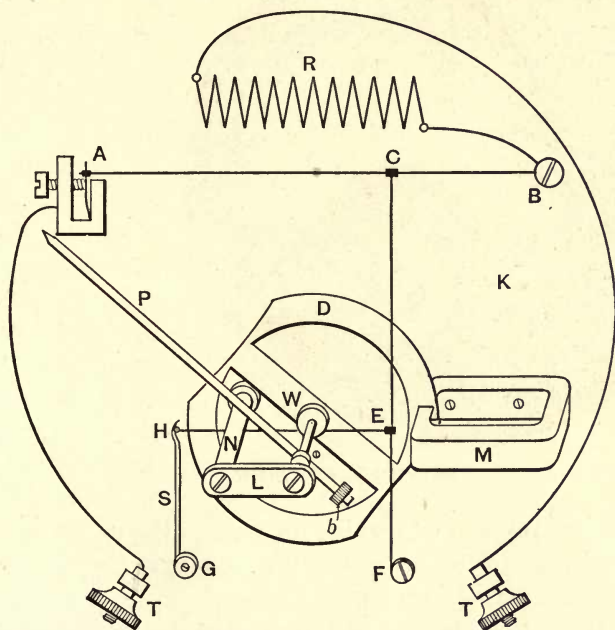

Fig. 157.—Principle of Hartmann & Braun Hot-Wire Voltmeter

to the spindle, and the spindle is carefully balanced by a balance-weight *b*, so as to rest in any position of the revolution when freed from the fibre HE. The disc D as it turns round is capable of moving between the poles of a permanent steel magnet M, the arrangement constituting the Foucault damping device in the instrument. The action of the instrument will be at once obvious. The spring s always tends to keep the fibre HE and wires CF and AB taut or in tension, consequently when the working wire AB becomes heated by the passage of the current it expands or

elongates, the corresponding "sag" being at once taken up by the spring *s*. The result is, that the fibre *HE* moves bodily to the left, causing *w*, round which it is wound, to turn, and the pointer *P* to take up a certain position on the graduated scale (not shown in fig. 157) corresponding to the current through, and consequent heating of, *AB*. By the system of wires, fibre, pulley, and spring, therefore, any sag in *AB* is greatly magnified, causing the deflections of the pointer to be easily discernible and the scale

divisions to be not only wide but open at the part where most desirable.

For ranges up to 400 volts a non-inductive resistance *R* of "constantan" resistance material is placed in the back of the instrument, where special means are provided for efficient ventilation. It is connected in series with the working wire *AB*, as shown in fig. 157, *TT* being the terminal

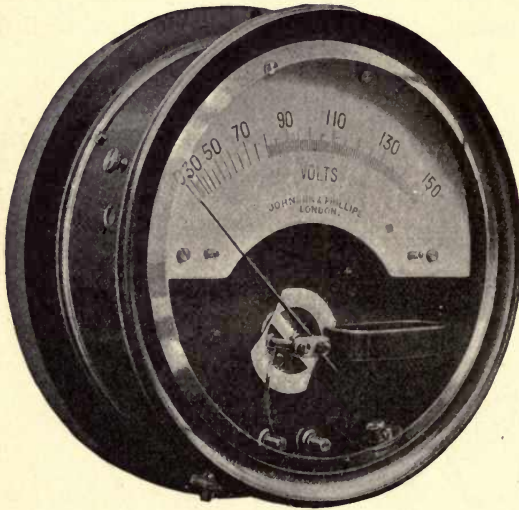

Fig. 158.—Hartmann & Braun Hot-Wire Voltmeter

proper of the voltmeter to which the extremities of the combination of *AB* and *R* are connected. For higher ranges than 400 volts this resistance *R* is placed in a separate case.

Fig. 158 shows the general form of the instrument complete for switch-board and other purposes.

Since the quantity of heat developed by unit current in unit time is the same for both continuous and alternating current of any periodicity or wave form, and further, since this class of measuring instrument works by the heating effect of a current and not by its electro-magnetic effect, the self-induction of the arrangement is practically nil, and therefore the scale readings are equally accurate on both direct and alternating-current circuits. They are entirely unaffected by external magnetic fields, and are almost dead-beat. The action of the Foucault damping device is that currents are

induced in the ring disc *D* as it moves across the magnetic field developed between the poles of the permanent magnet *M*, these induced currents circulating in the rim of *D* in such a direction that they tend to oppose the motion which produces them. Thus the oscillations of the pointer *P* are so damped that the motion is almost dead-beat.

Means are provided outside the case for enabling the pointer *P* to be adjusted to zero on the scale, should the necessity for so doing arise through overstraining the instruments. This is indicated symbolically in fig. 157 by the spring and set-screw at the end *A* of the working wire. This, however, does not affect the scale graduations. This form of hot-wire voltmeter takes less current than other instruments working on the same principle, that required to deflect the pointer over the full scale being about 0.22 ampere.

A thin metal plate placed near the working wire *AB* protects this latter from air disturbances and tends to ensure a more uniform heating of the wire.

For high pressures the whole of the mechanism is highly insulated from the case by ebonite.

Hartmann & Braun's Hot-Wire Ammeter

This instrument, with the exception of one or two slight modifications in connection with the working hot wire and its extra resistance, is precisely similar to the hot-wire voltmeter (p. 134) of the same name. It is manufactured in this country by Messrs. Johnson & Phillips, and is a somewhat new departure in the application of the hot-wire principle to ammeters intended for large currents.

The distinguishing difference from the hot-wire voltmeters of the same name lies in the arrangement of the working hot wire. Referring to fig. 159, which shows symbolically the wire and part of the magnifying gear, which latter is described in detail in fig. 157, p. 135. The working hot wire *AB*, which is thicker than that used in the voltmeters, is divided into equal parallel parts of two or four by thin silver-foil strips *aed* and *AfB*. This enables 4 or 5 amperes to be passed through the parallel combination with a fall of potential of between 0.2 and 0.3 volt. The ordinary magnifying and indicating arrangements are fitted at *CEF*, as shown in detail in fig. 157. The parallel combination is shunted to a low-

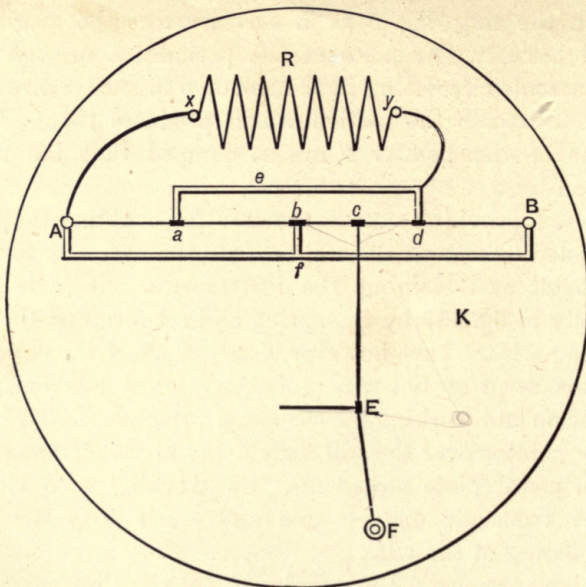

Fig. 159.—Principle of Hartmann & Braun Hot-Wire Ammeter

resistance constantan strip R , which can therefore be capable of carrying currents of almost any magnitude with a maximum fall of potential of from 0.2 to 0.3 volt.

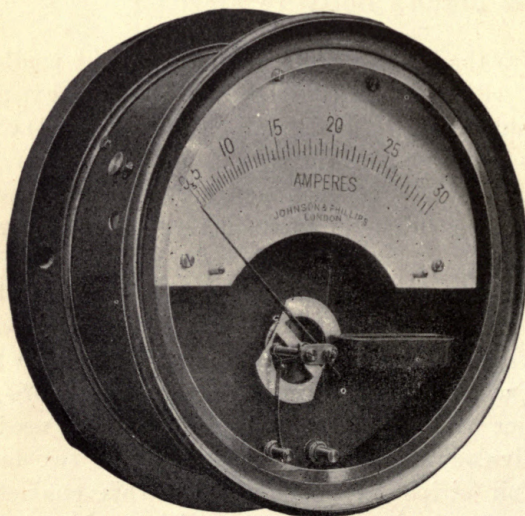

Fig. 160.—Hartmann & Braun Hot-Wire Ammeter

A general view of the complete instrument is shown in fig. 160, from which it will be noticed that the lower limit of useful range is about 10 per cent of the maximum reading.

The measuring wire is capable of standing, without

damage, double the normal maximum current marked on the instrument.

As was pointed out in the case of the voltmeter, and for the same reasons, this type of ammeter is a valuable one for accurately measuring alternating currents of any periodicity or wave form.

Ayrton & Mather Electro-Static Voltmeter (Gravity-Station Type)

This voltmeter, made by Messrs. Elliott Bros., Nalder Bros. & Thompson, and R. W. Paul, of London, is applicable for use on both direct and alternating-current high-tension circuits indiscriminately with the same scale.

It can be made for pressures up to about 12,000 volts, the most usual size being for 2400 volts.

The principle on which this instrument works, in common with all other electro-static voltmeters, depends on the electro-static attraction and repulsion between two conductors, one fixed and the other movable, connected with the two points whose potential difference it is desired to measure.

The construction of the instrument will be understood by a reference to figs. 161 to 164.

The moving needle *N* consists of two curved aluminium sheets *AA* (figs. 161 and 162) concentric with each other and the axis about which they turn, and carried by the three light arms *D*, on a horizontal spindle *F*, pivoted in jewelled centres. An extension of the arms at one end of the spindle terminates in a light flat copper plate *s*, which moves in a vertical plane between the poles of a strong permanent magnet *M*. The extremity of this plate *s* carries the pointer *P*.

The advantages of this form of moving needle or vane over those consisting of flat plates are: greater strength and lightness, less moment of inertia, and greater dead-beatness; and further, since the arms of the needle are in one piece with the curved portions, the electrical resistance, so serious with rapidly-alternating currents, even of the small frequencies met with commercially, is altogether eliminated.

The metallic inductors *I*, which are fixed to a metallic end-plate *H*, and carried by a corrugated ebonite block *E* fixed to the base of the instrument, are shaped so as to give any desired scale, namely, one of equal divisions or one spread out at a desired part of the range.

The inductors *I* are all in metallic connection, and fixed concentrically with the moving vanes *A* and the spindle *F*. The ebonite *E* forms a support of high insulation for them.

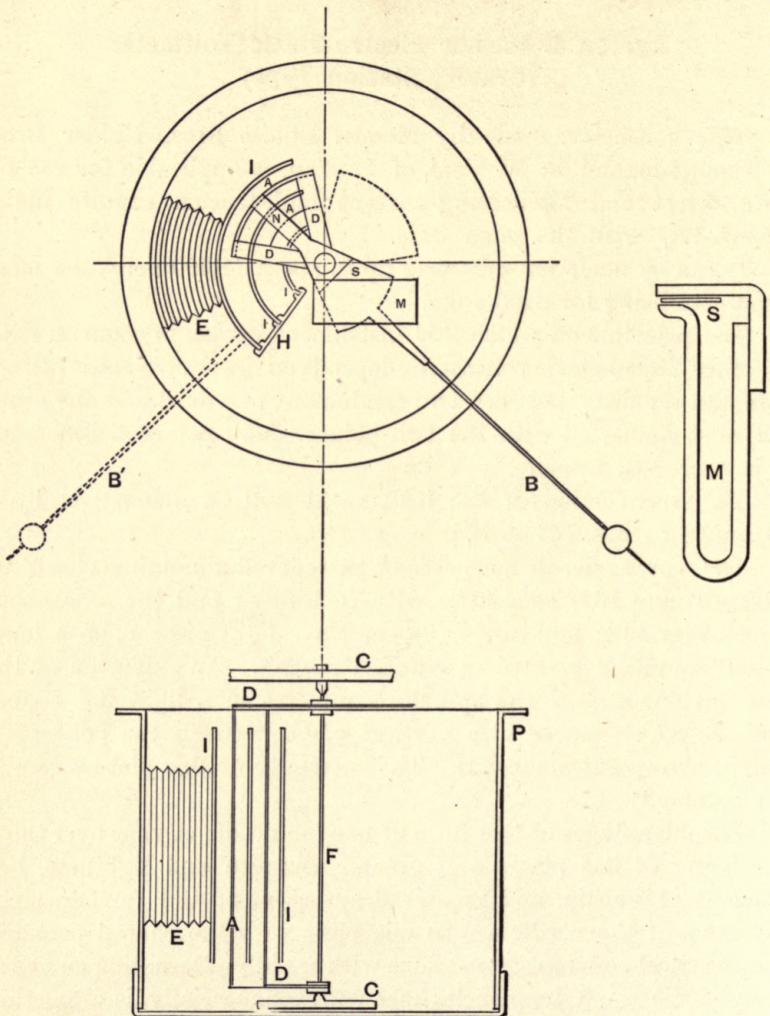

Fig. 161.—Principle of Ayerton & Mather Electro-Static Station Voltmeter

The dead-beat motion in this voltmeter is obtained by an electro-magnetic or Foucault damper, consisting of a strong permanent magnet *M* (fig. 161), fixed to the casting carrying the needle, and provided with a soft-iron pole-piece. A thin copper

sector *s*, which balances the needle, swings between the poles of this magnet, and damps the motions by the action of the Foucault currents generated in it.

A general view of the needle, damper, and pointer, with the bracket and disc which supports them, is shown in fig. 162, but the fixed inductors are not shown. Fig. 163 shows both fixed and movable inductors.

The working parts are entirely screened or surrounded by the metal of the case, from which they are highly insulated, and the pointer is not deflected by charged bodies outside the case or by rubbing the glass even with dry warm silk, as the glass is coated with a transparent conducting varnish, devised by Prof. Ayrton and Mr. Mather, and described by them in a paper read before the Institution of Electrical Engineers (*Jour. I. E. E.*, vol. xxiii, p. 376).

All the exterior parts of the instrument are insulated from the circuit, so that a person handling the instrument cannot receive a shock. The terminals, which screw into the case *B*, as shown in section fig. 164, each consist of an ebonite rod *A*. At the outer end a brass block *E* is embedded, and in this block the end of the connecting wire is held by the ebonite-headed screw *F*. The rest of the rod is hollow, and forms a receptacle for the fuse *C*, which is enclosed in a glass tube with metal caps, to which it is connected. The fuse is put in circuit by contact with the block *E* at one end and the cap *D* at the other. The latter projects into the case of the instrument, where it makes connection with a spring attached to the working parts. When a new fuse is required the terminal has only to be unscrewed from the case,



Fig. 162.—Moving System of Ayrton & Mather Electro-Static Station Voltmeter

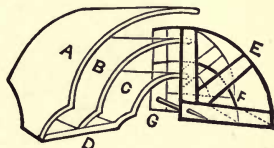

Fig. 163.—Moving and Fixed Inductors of Ayrton & Mather Electro-Static Station Voltmeter

and the cap D, which is fixed by a bayonet-joint, removed; then, sliding in the new fuse and replacing the cap, the terminal is screwed again in place.

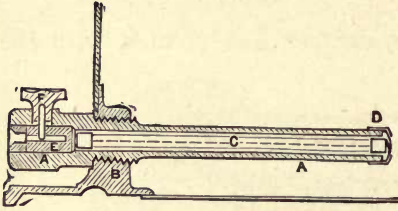

Fig. 164.—Insulated Terminal of Ayrton & Mather Electro-Static Station Voltmeter

In addition to the two terminals which are in series with the instrument, there is a spark-gap also in series with them inside the instrument, which is adjusted to allow the passage of a spark across this, instead of between the needle

and inductors, should the pressure rise suddenly to a high value.

The fuses blow when a spark passes at the gap, thus cutting the instrument out of circuit.

Fig. 165 shows the general appearance of the instrument, the

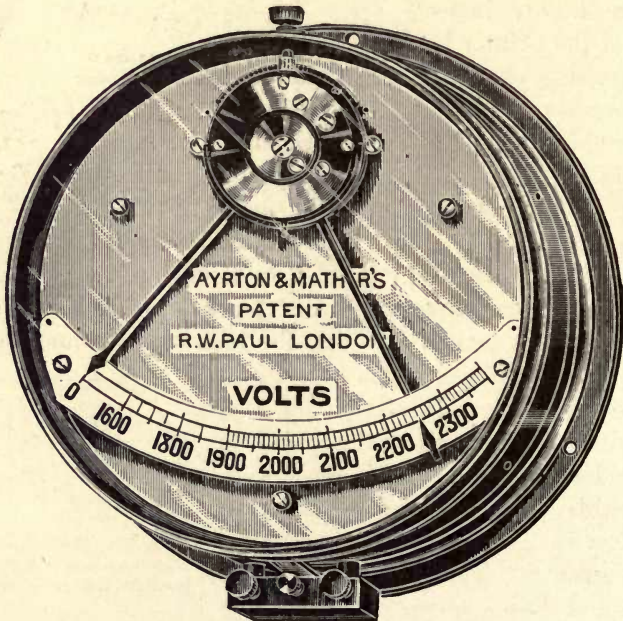

Fig. 165.—General View of Ayrton & Mather Electro-Static Station Voltmeter

ebonite-cased terminals being underneath. At the left-hand side a switch is sometimes fitted, the handle of which is outside the case. This switch makes contact with the cap D (fig. 164), enabling all the working parts to be disconnected from the terminals and

afterwards short-circuited, thus leaving the instrument completely discharged. A separate index pointer is fitted (seen pointing to 2250 on the scale), and is set by means of the crown-wheel and pinion, worked by the milled head at the top of the instrument, to the working pressure of the circuit. The main pointer can be clamped for transit by tilting the instrument and turning the index as far as it will go towards zero.

Ayrton & Mather's Electro-Static Voltmeter (for Low Pressures)

This form of electro-static voltmeter is primarily intended for pressures from 40 to about 600 volts, the lowest reading in the range of this type being about one-third of the maximum.

In principle, and partly in construction, it is similar to the high-tension standard-station type, but has a spring control in place of the gravity control used in that type.

The needle is of aluminium, balanced by the pointer, and delicately pivoted in jewelled centres on a vertical spindle.

The total weight of the moving part is less than 25 grains, so that the friction is very slight, and the creeping action absent.

Owing to the instrument being enclosed in the metal containing-case it is effectually screened from the effect of outside electrified bodies. Safety terminals and fuses are provided, which are precisely similar to those described on p. 141.

The case is highly insulated from the working parts, so that it is impossible to get a shock by touching the case.

The scale of these instruments is wide and open, as seen in fig. 166, being some 5 inches long and about 4 inches radius.

The motion of the needle is almost aperiodic.



Fig. 166.—Ayrton & Mather Low-Pressure Electro-Static Voltmeter

Kelvin's Multicellular Electro-Static Voltmeter (Laboratory Type)

This instrument, frequently designated the "horizontal-scale multicellular electro-static voltmeter", on account of its accuracy and constancy, constitutes a convenient portable standard for laboratory use. It is dead-beat in its movement, has a torsional control, and is made by Messrs. Kelvin and James White, of Glasgow.

The principle of this and of all voltmeters of this class, is that

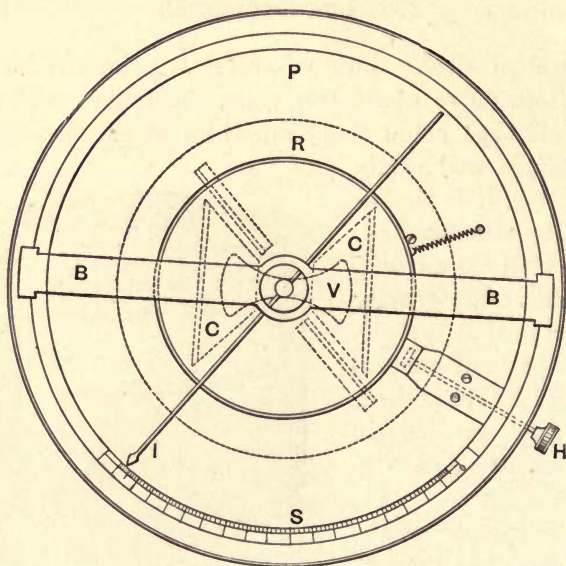

Fig. 167.—Kelvin Multicellular Voltmeter (plan)

of an air condenser, having one of its parts movable about an axis so as to increase or diminish the capacity. This condenser arrangement is enclosed in a metal case, for the double purpose of protecting the movable part from air currents, and from the disturbing influence of any electrified body outside, other than the fixed portion, differing from it in potential.

The construction of the voltmeter will be understood from a reference to fig. 167, which shows a plan, and fig. 168 an elevation, of this instrument. The fixed portions consist of two sets of quadrant-shaped cells *c* in metallic connection with each other, and formed of a number of triangular brass plates fixed into saw-cuts in a brass back-piece, so as to be at equal distances apart and

accurately parallel to each other. Two sets of these cells *c* are fixed relatively to each other, as shown in fig. 167, by an insulating vulcanite support to the sole-plate, so that their plates are horizontal and completely enclosed within the cylindrical brass case of

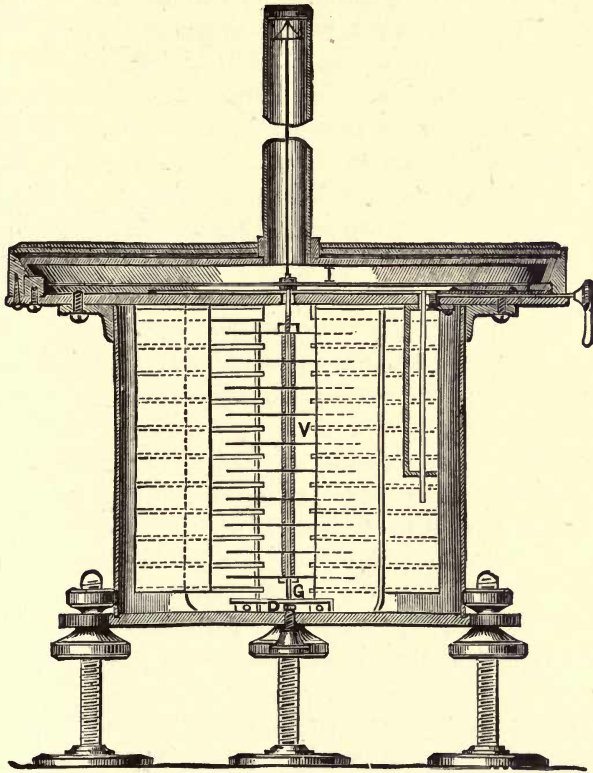

Fig. 168.—Kelvin Multicellular Voltmeter (side elevation)

the instrument. A terminal passes from them to an insulated binding-screw on the outside of the case.

On the top of this cylindrical case is a shallow horizontal circular scale-box containing the scale of the instrument, and having a glass cover which serves to protect the pointer *I* from air currents, and the scale and interior parts from dust.

The moving system consists of a number of aluminium vanes *v* (figs. 167 and 168), of the form shown in metallic connection with the case, through the medium of the fine suspending wire. The aluminium pointer *I*, by its deflection, indicates the potential
K

difference between the fixed and movable coatings of the condenser.

The moving vanes *v* are placed parallel to each other on a spindle with distance-pieces between them (fig. 168).

The top end of this spindle passes through a small hole in the sole-plate *P* of the instrument, which forms the bottom of the scale-box, and is attached to a small coach-spring, which in turn is secured to one end of a fine iridio-platinum wire suspended from a torsion head at the top of a vertical brass tube (fig. 168).

The torsion head may be turned by means of a forked key provided for the purpose, and is clamped to protect it from accidental displacement by a cap which screws on to the end of the tube.

This coach-spring, which is thus interposed between the suspending wire and the spindle carrying the vanes *v*, has sufficient resilience to allow the spindle to touch the guard-stop, and so to save the suspension from injury in the event of the instrument being roughly set down.

Two vertical brass repelling plates, which also act as guard-plates to prevent the movable part from turning beyond its prescribed limits, are fixed to the bottom of the sole-plate. These two plates, seen in figs. 167 and 168, carry a guide-plate *G* with a hole in it, through which the lower end of the spindle passes.

A little brass disc or head *D* is attached to the end of the spindle, and is sufficiently large to prevent its passing back through the hole in *G*.

Thus the movable part is effectually secured from swinging about so as to be injured, and by no possibility can it come into contact with the insulated quadrants. When the instrument is level the spindle hangs free by the suspending wire, so that the vanes are horizontal, and each is in a plane exactly midway between those of two contiguous condenser plates. A small thumb-screw is placed near the centre of the base-plate under the instrument, which can be screwed in so as to lift the weight of the spindle and vanes from the suspending wire, and clamp the disc *D* on the end of the spindle against the guide-plate *G*.

A light brass ring *R*, actuated by the ebonite handle *H*, seen on the right-hand side of the scale-box in figs. 167 and 168, is provided, and serves to check the motion of the pointer.

The damping arrangement (fig. 169) consists of a thin metal disc

hung from the lower end of the spindle, dipping into an oil-pot, in which it turns, thus giving the moving system a dead-beat motion.

A switch is attached to the insulated terminal of the instrument, by which the voltmeter can be cut out of circuit when desired. The switch, after breaking circuit, puts the case and insulated cells in metallic connection. Fig. 169 is a general view of the voltmeter, and shows the switch on the right-hand side of the brass case, the plummet-line for levelling the instrument, and the vane inside the oil dash-pot underneath the case. When using the voltmeter the preliminary operations are to see—(1) that the clamping thumb-screw is unscrewed to allow the moving system to swing freely; (2) that the instrument is levelled so that the plummet-line passes down centrally through the intersection of the two black cross-lines on the sole-plate; (3) that the pointer is accurately at zero on the scale. If adjustment for this is necessary, unscrew the cap on the top of the tube, remove the washer, turn the torsion head by means of the forked key until the pointer *I* (fig. 167) is exactly opposite zero on the scale, with the switch connecting the insulated cells to the case. The washer must then be replaced, and the cap screwed on again.

Multicellular Voltmeter Multiplier

When it is desirable to measure with one electro-static voltmeter over a long range, a "multiplier" may be used, consisting of a series of non-inductive resistances, suitably arranged in a case, with switch for giving several constants by which to multiply the scale reading.

Such an arrangement for use with the horizontal laboratory pattern is shown in fig. 170, and fits over the suspension-tube of

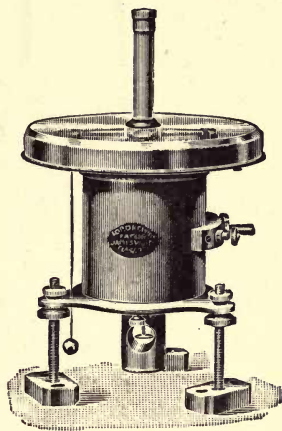

Fig. 169.—Kelvin Multicellular Voltmeter (Dead-beat pattern)

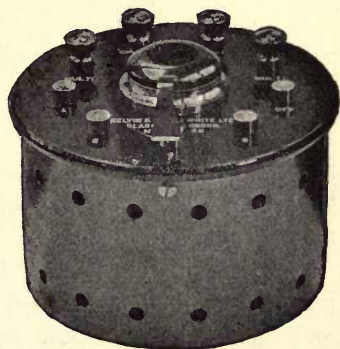

Fig. 170.—Kelvin Multicellular Voltmeter Multiplier

the instrument during the carriage of it. It should be remembered that since the resistance of an electro-static voltmeter is "infinite", the multiplying cannot be obtained by resistances in series with it.

The way, however, that the multiplying is done is shown in fig. 171, which gives a sketch of the connections of fig. 170, from which it will be seen that the voltmeter *v* can, by moving the switch lever *L*, be shunted across accurate

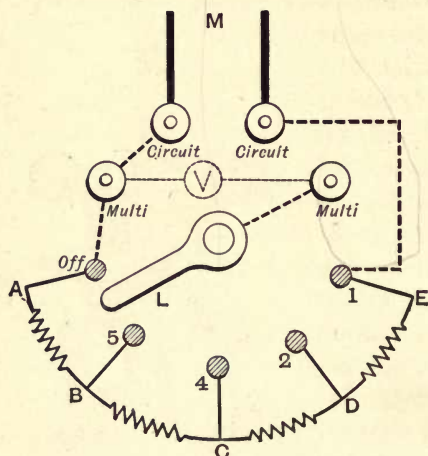

Fig. 171.—Principle of Kelvin Multicellular Voltmeter Multiplier

fractions *AB*, *AC*, *AD*, of a high resistance *AE* placed directly across the mains *M*, which therefore carries a constant current if the main pressure is constant.

Hence, if *AB* is $\frac{1}{5}$ of the whole resistance *AE*, the voltmeter *v*, when *L* is on stud 5, will just read $\frac{1}{5}$ of the total voltage, and hence to get this latter the readings must be multiplied by 5.

Similarly, if *L* is on stud 4, *AC* must be $\frac{1}{4}$ of *AE*, and so on. The arrangement, therefore, may be most useful when higher voltages have to be measured than the actual voltmeter is calibrated to.

The multiplier illustrated in fig. 170 is suitable for 600-volt circuits,

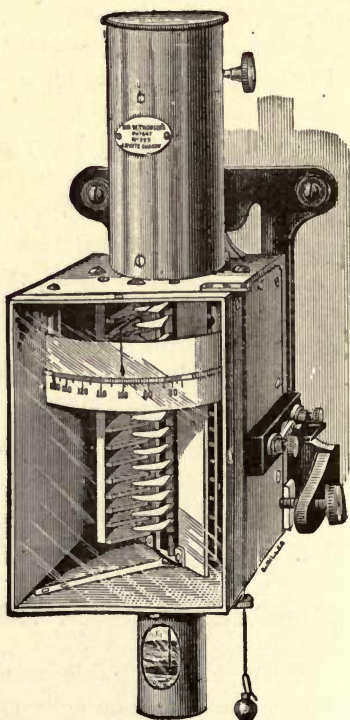

Fig. 172.—Kelvin Multicellular Voltmeter (Engine-Room vertical pattern)

Kelvin's Multicellular Electro-Static Voltmeter (Vertical-Scale Engine-Room Type)

This instrument merely differs slightly in outward appearance, and in one or two details, from the laboratory form just described. It is intended for switch-board work where a vertical scale is required, and is a standard instrument constructed in precisely the same way as the form above-named. It consequently has a torsional control, and is dead-beat, the range of scale, however, being shorter, and of very nearly equal divisions throughout. Fig. 172 shows the instrument complete, with its attachment for fixing to the switch-board.

Kelvin's Multicellular Electro-Static Voltmeter (High-Tension Dial Form)

The chief difference between this form and the laboratory one is that the vanes move about a horizontal axis (under a gravity

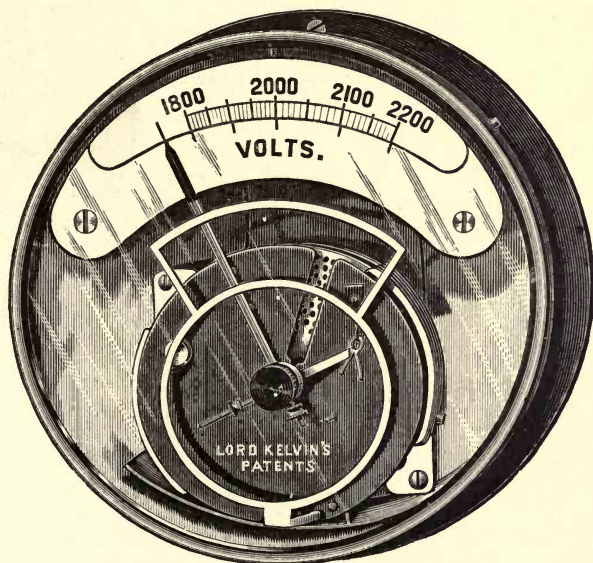

Fig. 173.—Kelvin Multicellular Voltmeter (High-Tension pattern)

control) on knife-edges, which connect them to the terminal on the case. It is intended for station use, where a short range and large open scale divisions at the working part are required

for voltages above 1500. Owing to the use of knife-edges, the indications are free from the frictional error attending the use of pivot bearings. Fig. 173 shows the general view of an instrument intended for measuring pressures from 1800 to 2200 volts.

Voysey & Wilson's Electro-Static Ampere Meter (For Alternating Currents Only)

This instrument has been made by Messrs. Kelvin & James White, and was specially designed to facilitate the control or super-

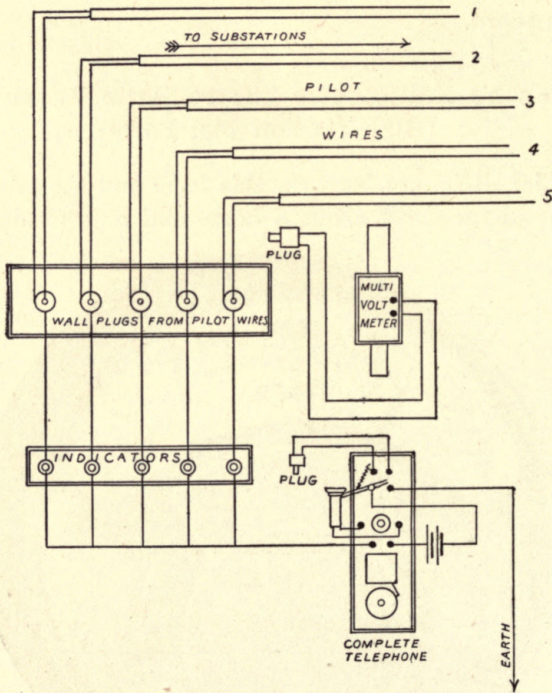

Fig. 174.—Voysey & Wilson's Electro-Static Ammeter

vision of sub-station distribution. By means of it the engineer at the sub-station or at the central station can ascertain the E.M.F. at the feeder bus bars, or the current passing.

The instrument consists of a Kelvin electro-static multicellular voltmeter, fitted with three ampere scales in addition to the ordinary voltmeter scale, and a maximum reading-pointer, by

means of which the maximum current passing through any feeder is automatically registered.

The current to be measured passes through the heavy wire winding of a specially-constructed box transformer, the secondary of

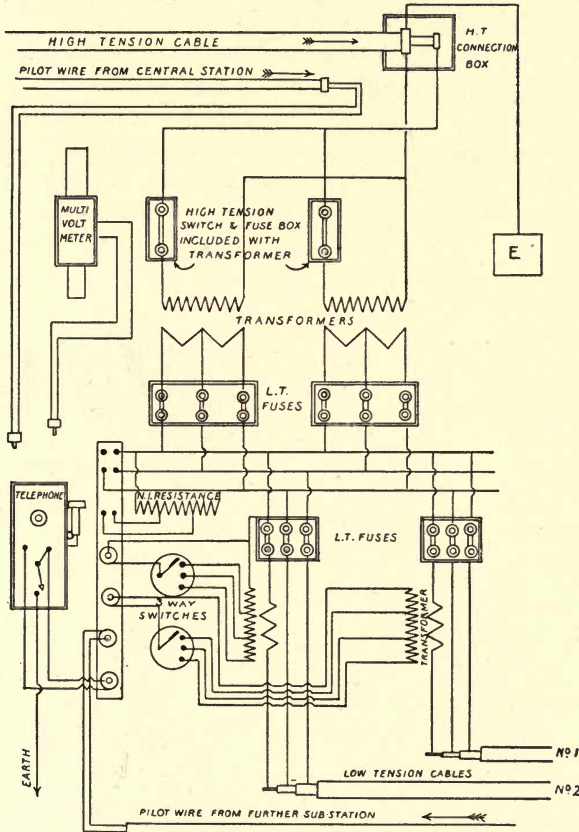

Fig. 175.—Voysey & Wilson's Electro-Static Ammeter

which is divided into four sections, and connected by means of a spring switch and an ordinary wall-plug to the voltmeter.

The effect of this arrangement is that the current to be measured can always be read at the best part of the voltmeter scale, and the range of the instrument is practically unlimited.

The diagrams (figs. 174 and 175) show the connections of these instruments, and indicate the means by which the pilot wires from the central to any sub stations may be used.

By means of this apparatus the pilot wire can be used to show at the central station:—

The pressure across the L.T. bus bars.

The pressure at any distant point.

The current passing through the L.T. bus bars, or through one individual distributor.

It can also be used for telephone purposes in the usual way.

The indications of the multicellular voltmeter, used as an ampere meter, are, of course, independent of temperature errors, C^2R losses, &c., so that pilot wires of any length may be used without interfering with the accuracy of the readings.

CHAPTER V

ELECTRO-MAGNETIC WATTMETERS

When it is desired to measure directly the electrical power developed in any circuit, it is often convenient, and sometimes absolutely necessary, to employ an instrument termed a *wattmeter*, which, as its name implies, measures the watts taken up in a circuit to which it is connected.

Such an instrument is not, however, of very great use in direct-current work, since the amperes and volts are usually obtained separately, and the product at once gives the power expended in the circuit.

With alternating currents the case is quite different, since the product of the square root of the mean square values of amperes and volts, as read off on an alternating-current ammeter and voltmeter respectively, does *not* give the true power developed, but only what is termed the apparent power, when the circuit contains capacity or self-induction, as it usually does in practice. What is required here to give the true or actual power in such a circuit is the *mean product*, which the wattmeter indicates, and *not* the *product of the means*. In fact, the instrument is of incalculable value in alternating-current work, since, if it is nearly *non-inductive* itself, it is the best-known means of measuring the *true power*.

Since they possess both current and pressure coils acting on the moving-coil dynamometer principle, they are affected by many of the errors common to electro-magnetic ammeters and voltmeters.

Thus, wattmeters are liable to those errors mentioned on p. 18, and, in addition, to errors due to change of temperature, which can be minimized in the manner described on p. 14—

To errors due to external magnetic effects.

To errors due to the self-induction of the fine-wire coil or circuit causing a lag in phase of the current passing through it behind the potential difference to which it is applied.

The fact that the self-induction of the pressure-coil is reduced to as low a value as possible gives rise to the term *non-inductive* wattmeter. It is attained by only winding a few dozen turns inductively on the coil, the remainder of the circuit composing the resistance of the fine-wire circuit being wound non-inductively on the same or a separate frame. It has also been proposed to annul the self-induction of the fine-wire circuit by connecting a suitable capacity in circuit with it. The correcting factor of any wattmeter when it is appreciably inductive will be found on p. 170.

To be the really valuable instrument that it should be, the wattmeter must be carefully constructed so as to have as few metal parts about it as possible, and no iron. Also, any metal parts that cannot be avoided, as well as the copper strip, if used for the current coil, should be slotted at intervals so as to still further diminish eddy currents in the instrument. With such precautions as these, the wattmeter will measure direct as well as alternating power of any periodicity or "wave form" equally accurately.

The controlling force on the movable coil is usually that produced by two light hair-springs, which also serve to lead the current into and out of the moving coil.

In some few instances mercury cups serve to do this. In a well-designed instrument the power absorbed by the wattmeter itself is small, that in the fine-wire circuit alone being reduced to a little under 2 watts in the best instruments.

Another error which may creep in is due to the magnetic effect of the earth's field, corrected for in the manner described on p. 65.

We will now consider in detail the most important of the wattmeters met with in practice at the present time.

Siemens' Dynamometer Wattmeter

In general appearance and construction, the form of wattmeter now under discussion, which is made by Messrs. Siemens Bros. & Co. of London, is precisely similar to the Siemens electro-dynamometer (p. 62), except in the matter of the movable or swing coil. A diagrammatic view of the principle of construction is consequently not given, but is practically that given in fig. 71, to which reference should be made.

A general view of the wattmeter is shown in fig. 176, and the only difference between this and the dynamometer described in fig. 71 lies in the moving coil.

This in the wattmeter, fig. 176, consists of a large number of turns of fine insulated copper wire wound on a light rectangular frame of wood or ebonite or some non-metallic substance.

Only a few of the turns are wound inductively, the remainder being doubly wound, so as to be non-inductive, and in addition to give, if possible, a small electro-static capacity.

The total resistance of the moving coil will, of course, be that due to the sum of all the turns on it, and may amount to 5000 ohms or more.

Current is led into and out of the fine-wire moving coil through thicker wires, soldered to the ends of the fine wire, and dipping into the two mercury cups.

These cups are connected to the two small terminals seen in fig. 176,

on the base of the instrument to the extreme right and left.

The fixed thick-wire coil is connected to the two centre larger terminals, and carries the main current.

Thus there is no electrical connection between the fixed thick- and moving thin-wire coils in the wattmeter itself.

The plumb-line is absent here, a spirit-level only being provided for levelling the instrument.

The scale at the top, which may be divided into degrees or other convenient equal divisions, presents one or two features which differ from those usual in this make of instrument. A glass

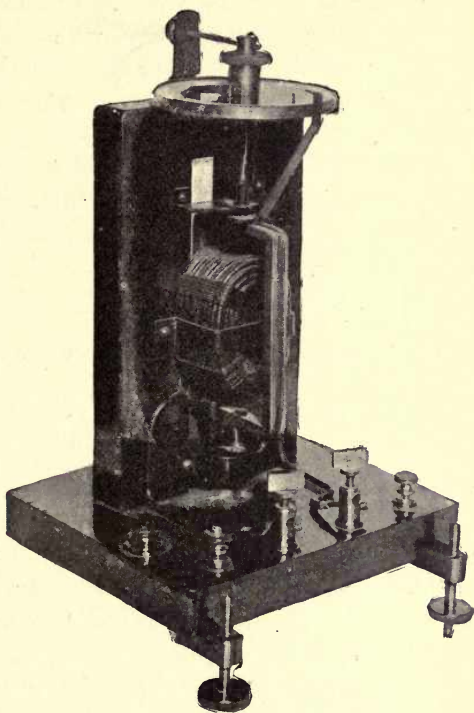

Fig. 176.—Siemens' Electro-Dynamometer Wattmeter

mirror disc covers the scale, but has a strip of the silvering removed just over the scale. This enables the latter to be seen without allowing it to get dusty or dirty. Errors due to parallax in reading the position of the torsion head pointer are thus eliminated.

When the instrument is connected up to a circuit, *i.e.* with its thick coil in series with one of the mains, and the fine-wire moving coil across the two mains, the moment of the couple, or force, causing the deflection of the moving coil $\propto c_1 \times c_2$, where c_1 = current in the moving and c_2 that in the fixed coils respectively.

If now the torsion head has to be turned through an angle D indicated by its attached pointer on the fixed scale, in order to bring the index to zero, then, as in the case of the Siemens dynamometer,

$$D \propto c_1 \cdot c_2;$$

but c_1 is \propto to the voltage v across the mains.

$$\begin{array}{l} \text{Hence} \quad D \propto v c_2 \propto \text{watts,} \\ \text{or} \quad \quad \underline{w = k D \text{ watts,}} \end{array}$$

where k is the constant of the instrument.

This last relation is known as the *Law of the Siemens dynamometer-wattmeter*.

The same precautions are necessary in using the wattmeter as in using the dynamometer, and two additional errors may occur, one through the warming up of the moving coil due to the temperature of the air or effect of the current in it, and the consequent alteration of its resistance (*vide* p. 14), the other due to the effect of the earth's field (p. 65).

The Weston Standard Portable Non-Inductive Wattmeter

The principle involved in the construction and action of this instrument, supplied in this country by Messrs. Elliott Bros., is the electro-dynamical action between a moving fine-wire coil and fixed thick-wire coils.

It is essentially the same as that employed in the Weston portable standard voltmeter for alternating and direct currents, which was described in some detail on p. 80, *et seq.*

In the wattmeter, however, the main current passes through the stationary field coils *MM* (fig. 87, p. 81), which now consist of a few turns each of comparatively thick copper wire or strip.

The movable coil *c* (fig. 87, p. 81) is placed in series with a suitable non-inductive resistance, and carries merely a voltmeter current, being connected directly across the mains.

Hence the moment of the couple exerted between the moving and fixed coils, which is a measure of the watts developed in the circuit, causes the moving coil to deflect against the force of the controlling springs through a certain angle, the amount of which is indicated by the pointer on the scale.

The instrument is graduated directly in watts, and can be left in circuit for any length of time. Errors due to change of temperature are eliminated by the use of the Weston patent-alloys with negligible temperature coefficient. Errors due to magnetic lag and self-induction in the moving coil are negligible, and the motion of this latter can be damped by the brake described on p. 82.

Fig. 177 shows the general view of the wattmeter, having the main terminals at the left, the fine-wire ones on the top, and the brake push in front on the top.

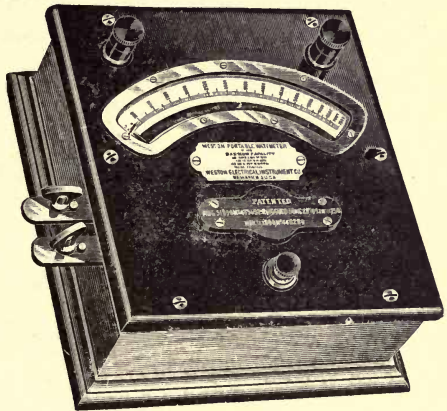

Fig. 177.—Weston Portable Wattmeter

Kelvin Engine-Room Wattmeter

This is a station type of instrument, intended for measuring the true power direct in watts or kilowatts, whichever units the scale is graduated in, and can be used in either direct or alternating current circuits. It really belongs to the electro-dynamometer class of measuring instrument, and has a spring control.

Fig. 178 shows the general view of the interior with cover removed.

It consists of a main coil of copper rod bent into the form of the figure 8, and mounted on a slate back of high insulation, so that the magnetic axes of the two loops thus formed are vertical.

The ends of this thick circuit are joined to massive terminals, which are connected in series with one of the mains.

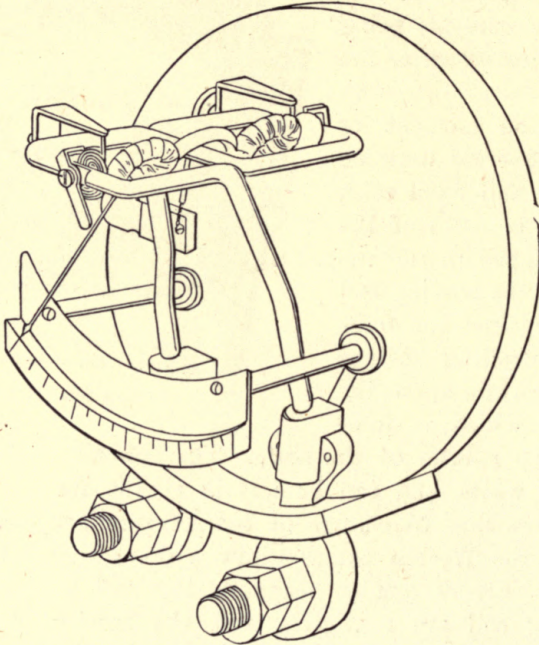

Fig. 178.—Kelvin Engine-Room Wattmeter (case removed)

The two shunt coils, wound with fine insulated wire, are arranged astatically on a light but strong aluminium frame, as shown in fig. 179, which depicts the fine-wire moving shunt coils, method of suspension, and control detached separately from the instrument.

One end of this frame has a circular knife-edged hole fixed to it, and the other end has a straight knife-edge. These two knife-edges rest on two phosphor-bronze hooks attached by insulating supports to the outside ends of the double rectangle. By this method of suspension complete freedom from friction is obtained, while the movable system is kept in a definite position without end guides.

Each fine-wire coil has about 1000 turns of insulated wire, and its resistance is about 100 ohms. The current is conducted in and out from the movable system by two flat palladium spiral springs which also supply the restoring force for governing the sensibility of the instrument. Not more than $\frac{1}{20}$ ampere is required through the fine-wire circuit; and, in order to obtain this, a large non-inductive resistance is rolled on the case of the instrument, which offers a large cooling surface, and is placed in series with the moving coils, the combination being connected directly across the mains. The scale has nearly

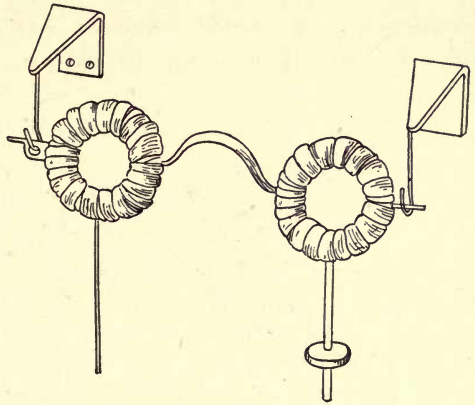

Fig. 179.—Kelvin Engine-Room Wattmeter (moving system)

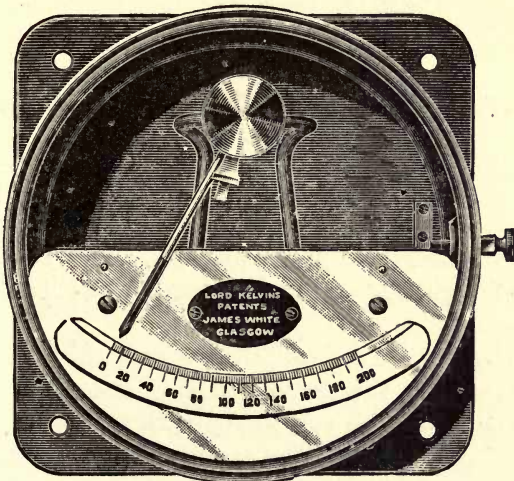

Fig. 180.—Kelvin Engine-Room Wattmeter

uniform divisions, and is graduated to read directly in watts or kilowatts as required.

Fig. 180 shows the general appearance of the finished instrument.

Kelvin Three-Phase Wattmeter

This instrument is merely a slight modification of the preceding one, and reads direct in watts or kilowatts, giving the total power supplied to the system, whether the circuits are

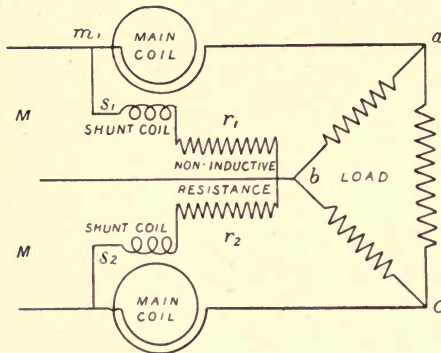

Fig. 181.—Principle of Kelvin Three-Phase Wattmeter

balanced or otherwise. It has two separate main coils forming the two loops of the ordinary wattmeter above described, insulated from each other, and connected each to its own pair of terminals.

These act on the identical shunt-coil system shown in fig. 179, to which the pointer is attached, and for pressures up to 250 volts

the two non-inductive resistances in series with each fine-wire coil are inside the instrument. Fig. 181 shows the arrangement of connections for this three-phase wattmeter.

Everett, Edgumbe, & Co.'s Wattmeters

These instruments take three different forms, according to whether they are intended for *laboratory*, *portable*, or *switch-board* work.

They are modifications of the Swinburne type of non-inductive wattmeter (*vide* p. 323), and are all based upon the dynamometer principle.

In each there is a fixed coil, wound with thick wire or copper strip, which carries the main current, and this acts electro-dynamically on a movable coil wound with fine insulated wire and having a torsional control. The arrangement of coils is somewhat similar to that in the Siemens' dynamometer-wattmeter (p. 155).

In the laboratory type the moving coil is suspended by two fine phosphor-bronze wires, one above and one below. The upper suspension is attached at the top to a milled head carrying a pointer, which moves over a graduated dial.

In series with the moving coil is a high non-inductive resistance,

the whole combination being connected across the mains and forming the voltmeter of the arrangement.

The currents through the fixed and moving coils cause the latter to deflect; and the angle turned through by the milled head in bringing the moving coil back to its zero position is directly proportional to the watts.

The resistance in series with the moving coil is not only wound non-inductively, but also in sections, in order to avoid capacity, which is quite as prejudicial as self-induction to the accuracy of the wattmeter readings. This method of winding has the further advantage of increasing the insulation by reducing the voltage between neighbouring wires.

Every care is taken to dispense with all metal parts or fittings in these instruments, except what are absolutely necessary, and these are then made of the high-resistance alloy German silver. By this means the disturbing effect of eddy currents is minimized.

The current taken by the moving coil varies in different instruments from $\frac{1}{30}$ to $\frac{1}{100}$ ampere, and is led into and out of the coil by means of the phosphor-bronze suspensions above-mentioned.

The portable type of wattmeter of this make is similar in general construction to the above, except that the moving coil is pivoted and carries a pointer which moves over a direct-reading scale.

The control in this type is effected by two hair-springs, which also lead the current into and out of the moving coil.

The current taken by the moving coil varies from $\frac{1}{10}$ to $\frac{1}{40}$ ampere, and the same care is taken with the construction as in the preceding type.

The switch-board type is similar to the portable form, but is of course contained in a circular case.

Siemens' "Precision" Wattmeter

This instrument, made by Messrs. Siemens Bros. & Co., of London, is a *direct-reading* moving-coil wattmeter, as distinguished from the now universally-known dynamometer-wattmeter (p. 155), which is a zero instrument and not direct-reading.

The construction of the "Precision" is simple, and the instrument is well-designed, as will be understood from a reference to figs. 182 to 185.

It consists, as seen, of a moving volt coil *C* wound with fine insulated wire on a rectangular former, which is finally removed, so that it is composed only of wire and insulating material without metallic or other shuttle. It consists of 400 turns of 0.1 millimetre wire in eight layers, and has a resistance of 100 ohms with a self-induction of 0.0088 henry. A non-inductive resistance in series with this brings the total resistance of the volt coil circuit within the instrument to 1000 ohms.

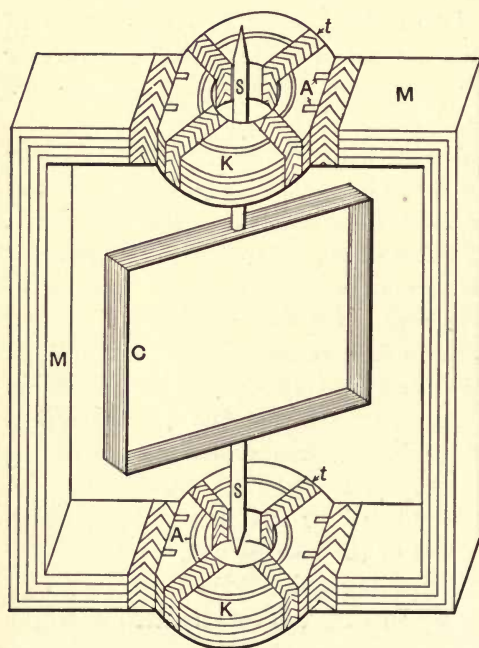

Fig. 182.—Principle of Siemens' "Precision" Wattmeter—
perspective elevation of Fixed and Moving Coils

This arrangement constitutes the air damper for giving a dead-beat motion to the moving system, which is very light throughout though sufficiently strong.

The moving coil with its attachments is deflected by the magnetic field produced by a fixed copper coil *M*, which carries the main current.

The planes of the two coils make a small angle when the moving coil is at zero.

The fixed coil is built up of 64 strips of sheet copper 0.3 mm. thick and 14 mm. wide. In the smallest size of this type of watt-

The moving coil is controlled by two flat spiral hair-springs (not shown), both at the top end of the fine steel spindle *SS* that carries the moving coil *C*, and runs in jewelled centres (not shown). The light-pointed *P*, fig. 183, is attached to the spindle or coil, and also a light rod *r* curved into the arc of a circle and carrying a thin light piston disc *B* at its end.

This disc works in and out of the curved ebonite tube *T*, one end of which is sealed and the other open.

meter. made for currents up to 12.5 amperes, the above strips are all connected in series forming a coil of 32 turns, and are insulated from each other by varnished paper.

In the instruments for 25 amperes as a maximum, the above number of turns are connected to form 2 coils of 16 turns each, in parallel; for 50 amperes, 4 coils of 8 turns; and for 100 amperes, 3 coils of 4 turns are formed; and so on. The resistance of the fixed coils for 12.5 amperes at 17° C. = 0.0374 ohm, and the fall of potential down them at full-load current = 0.467 volt, the watts used up in this fixed coil being consequently 5.34.

The self-induction of the fixed coil = 0.000056 henry, and the mutual induction between the fixed and movable coils when the pointer is at zero = about 0.00016 henry, and is less, of course, at other positions of deflection.

Referring to figs. 182 and 183, it will be noticed that the thick coil is enlarged at the top and bottom, as shown at $\kappa \kappa$, to allow for the holes through which the spindles of the moving coil protrude. These portions are also slotted in the direction of their length, as at A, fig. 182, to diminish eddy currents when alternating currents are used.

The turns are bound securely together by tape t , as shown, but the ends are not shown that form the terminals of this main-current coil.

The force acting on the moving coil varies as the product of the currents in the two coils, *i.e.* as the watts, so that the deflection is \propto to the watts absorbed in the circuit tested.

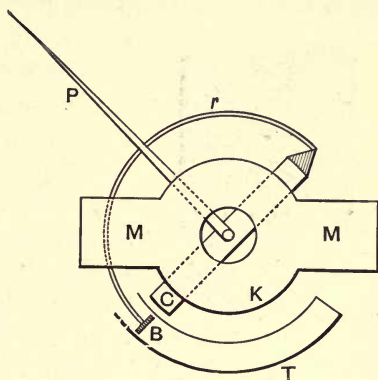

Fig. 183.—Plan showing the Principle of Siemens' "Precision" Wattmeter

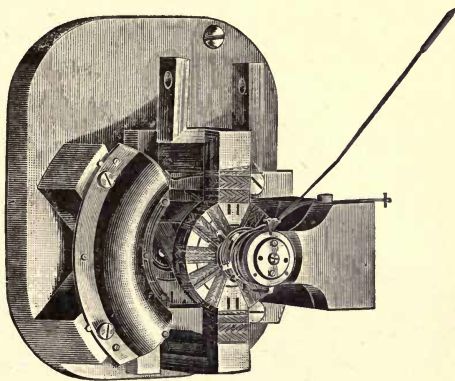

Fig. 184.—Interior of "Precision" Wattmeter, showing working parts

Owing to considerable care being taken in the construction, errors due to temperature variation, periodicity and wave form, and phase displacement caused by eddy currents in the instrument are practically eliminated.



Fig. 185.—Extra Series Resistance for the Moving-Coil Circuit of Wattmeter

The case and all possible parts are made of non-conducting material, to prevent induced currents in them. For voltages above 30 volts a separate additional series non-inductive resistance is used for the volt circuit, and is constructed of manganin wire with a negligible temperature coefficient. It is wound non-inductively in several sections upon bobbins allowing a free circulation of air.

Fig. 185 shows one of these series resistances in a perforated containing-case. The value of the resistance is so chosen that the current in the volt circuit does not exceed 0.03 ampere with the highest voltage for which it is intended. For voltages under 30 the wattmeter can

be used alone without extra series resistance, but for reasons given on p. 170 it is advisable to have non-inductive resistance in series when employing alternating currents in order to reduce the self-induction of the fine-wire coil.

Fig. 184 shows the general view of the interior of a wattmeter, comprising the fixed coil, pointer, supports for moving coil, and air-tube damper.

In the case of the wattmeter for two ranges, the fixed coil is constructed in two sections, which can be connected either in series or parallel. The alteration of connections is made by means of

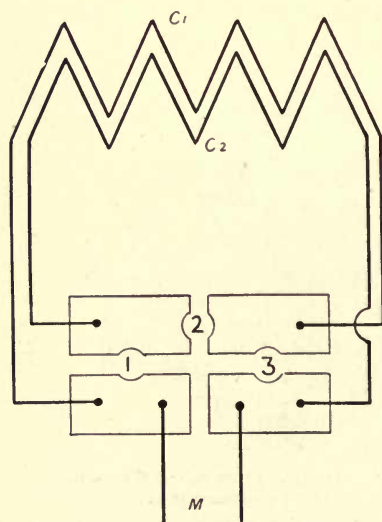

Fig. 186.—Diagram of Connections of Fixed Thick Coils to plug Switch-Board

plugs in the following manner:—To connect the coils in parallel for the higher range, the two plugs 1 and 3 (see fig. 186) are inserted and the plug 2 removed, and to connect the coils in series the plug 2 is inserted and the plugs 1 and 3 withdrawn. The plugs must

never be used to make and break the current, but care should be taken to insert the right plugs before switching on the current, and should it be desired to change the position of the plugs, the current must first be switched off, or else the terminals short-circuited. If this is neglected the full voltage may be present between the sections, and in case of high pressures damage may result.

The wattmeter may be placed on any table, and does not require levelling up. In making the current connection it is advisable to keep the two leads close to one another, or, better, to twist them together, also the instrument should not be used close to leads carrying heavy currents or other apparatus producing strong magnetic fields.

When measurements are being made with direct currents, the effect of the horizontal component of the earth's magnetic field must be taken into account. Reversing switches should therefore be included in both the current and volt circuits, and the mean of the readings taken with the directions of both currents changed.

The Electrical Co.'s Induction Wattmeter

These instruments are only applicable to the measurement of alternating currents, and will not work with direct currents. Their action depends on the electro-magnetic screening effect of induced or eddy currents, and in construction they resemble somewhat the phase meter described on p. 194.

Fig. 187 shows the general appearance of an induction wattmeter without case or scale. It consists of three well-laminated alternating-current electro-magnets; the pole-pieces of each embrace a light metallic disc, pivoted on a horizontal spindle in jewelled centres. The pointer and its balance-weight are also rigidly attached to this spindle. The central magnet is wound with thick wire, and is in series with the main-current circuit, the two outer

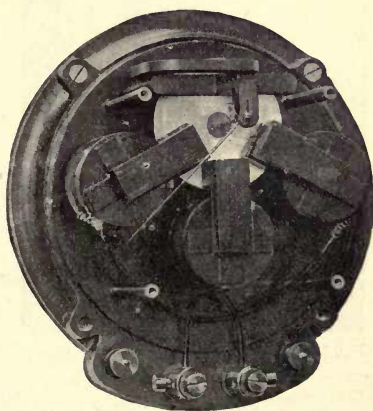

Fig. 187.—Interior of Electrical Company's Induction Wattmeter (case and scale removed)

ones being wound with fine insulated wire, and connected in series with a choking coil as a shunt, *i.e.* across the mains.

The pole faces of the two outer electro-magnets are fitted with metal screens, in the manner set forth on p. 113, and represented in fig. 187.



Fig. 188.—Electrical Company's Induction Wattmeter (general view)

The pivoted disc moves between the poles of a powerful permanent magnet seen at the top of fig. 187, which renders its motion dead-beat.

With the wattmeters of this class, current transformers can also be used, as well as with the ammeters; but, in order to obtain instruments for high-tension work, which will not have any high-

tension currents going to or from them, it is, of course, necessary for the shunt current to be transformed down to the lower voltage. This is obtained by means of a pressure transformer, which only differs from the transformers in ordinary use by a slight modification (see fig. 138).

Every wattmeter then has its special current and pressure transformer, in the same way as an ordinary wattmeter built on the dynamometer principle has its own resistance. The current transformer is made in the same way as for the ammeters, so that for very heavy currents a transformer can be used in order to reduce the section of copper in the instrument itself.

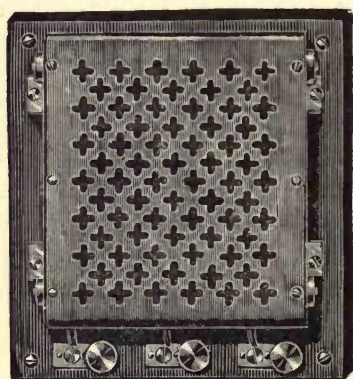

Fig. 189.—Choking-Coil Resistance containing Artificial Neutral Point

Fig. 188 shows the general appearance of the wattmeter.

The construction of high-tension wattmeters without the high-tension current flowing through the instrument itself is only possible with these induction instruments. With the ordinary dynamometer wattmeters, current and pressure transformers cannot be used on account of the lag in phase produced, which differs

essentially from the lag in phase of the current to be measured. With these induction wattmeters, however, it is possible to com-

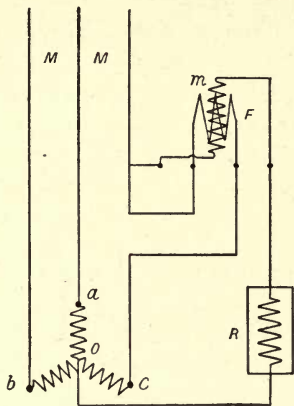

Fig. 190.—Connections of Wattmeter to Three-Phase Circuits (Star Grouping)

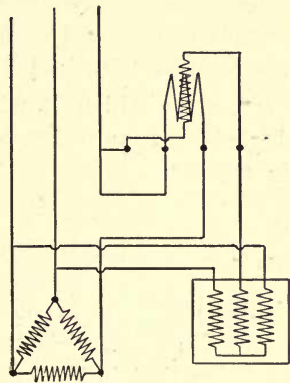

Fig. 191.—Connections of Wattmeter to Three-Phase Circuits (Mesh Grouping)

pensate for the lag in phase produced by the current and pressure transformers, so that the readings of the instrument are independent of $\cos \phi$, where ϕ is the angle of lag between current and pressure; and this property is possessed by this type of instrument only. If the instrument is to be used for three-phase currents, it is necessary either to have a neutral point for connecting the pressure coils to, or to use a special choking coil.

Fig. 190 shows the connections to a three-phase circuit with a star grouping, in which it will be seen that the thick coil *F* is in one of the three mains, and the thin coil *M* in series with the choking-coil resistance *R*, across this main and the neutral point *o*.

Fig. 191 shows the connection for the mesh or triangular

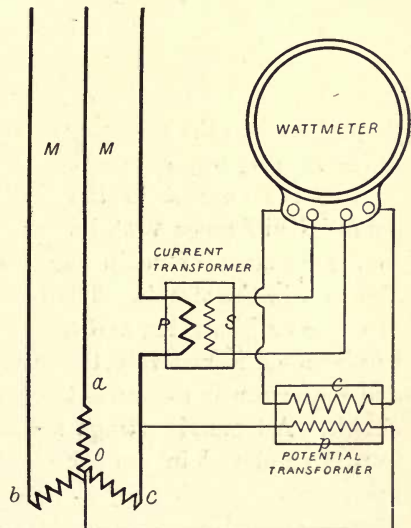

Fig. 192.—Connections of Wattmeter to Three-Phase Circuits (Star) through Pressure and Current Transformers

grouping, the pressure coils of the instrument being now connected to an artificial neutral point in the special choking-coil resistance, fig. 189, shown symbolically in fig. 191 on the right.

For pressures over 550 volts and currents over 1000 amperes, the wattmeter is used with both pressure and current transformers in the manner indicated by the diagram of connections shown in fig. 192, from which it will be seen that the instrument carries no high-tension pressure current, and only a small fraction of the main current.

Parr's Direct-reading Dynamometer Wattmeter

This instrument is constructed on precisely similar lines to that illustrated and described on p. 72, the only difference between them being that in the case of the wattmeter, the moving coils are wound with a few turns of fine wire, and are connected to a separate pair of small terminals.

The fixed thick-wire coils are connected to a pair of larger terminals and carry the main current, while the fine-wire coil is connected in series with a high resistance, non-inductively wound, across the mains.

The moment of the couple causing a deflection is therefore proportional to the products of the currents in the fixed thick- and in the moving fine-wire coils.

But the current in the latter is directly proportional to the potential difference v at its terminals. Hence the deflection is \propto to the product of main current and pressure, *i.e.* to the watts absorbed in the circuit. The instrument is therefore direct-reading in watts or kilowatts, and as the fine-wire coils contain only a few turns wound inductively, the instrument is practically non-inductive and consequently measures the true power in an alternating-current circuit. All metal fittings are avoided as much possible, and no iron is employed in the construction. The instrument has a wide open scale extending about nine-tenths of the circular dial, and is of the switch-board type. Its readings are independent of the frequency and "wave form" of the alternating current, and it of course reads equally accurately with direct currents.

Moving-Coil Alternating-Current Wattmeter

This instrument is almost precisely similar in principle and construction to the moving-coil voltmeter illustrated and described on p. 76. The same remarks apply to the instrument now under consideration, which is made by the Electrical Co. of London, as to the above-cited voltmeter, but in a more marked degree, as a wattmeter is an all-important instrument for measuring the true power absorbed in an alternating-current circuit.

The wattmeter consists of the ordinary stationary main-current coil and the movable-shunt coil, the stationary coil being made in two windings. The four ends of the windings are brought to a small terminal board attached to the instrument, so that the windings can be placed in series or parallel, giving in this way two ranges of current.

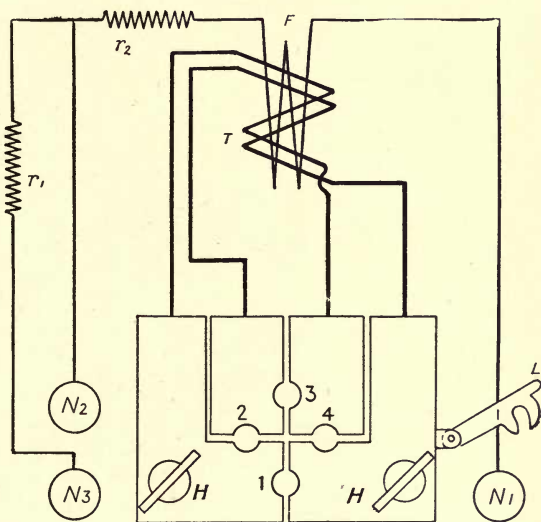

Fig. 193.—Connections of Pressure and Current Coils of Wattmeter to Terminals and Plug Switch-Board

This is carried out by means of two plugs shown in fig. 194, which is a general view of the instrument. Fig. 193 shows diagrammatically the connections, H denoting the main terminals, and 1 2 3 4 being the plug-holes. With a plug in No. 3 and the remainder unplugged, the two coils are in series. With the plugs in 2 and 4 and the other holes open, the two coils are in parallel, and the range of current doubled.

With the plug in 1, the instrument is cut out of circuit. This latter is of importance when the wattmeter is in circuit with induction motors, the starting current of which may be three or four times the normal working current, as this would otherwise damage the wattmeter. The shunt terminals are numbered as in

fig. 193, N_1 , N_2 , and N_3 . At N_1 is a contact arm for connecting one end of the shunt to the main supply. This has the advantage that with high-tension current measurements the difference in pressure between the moving and stationary coils can be largely reduced.

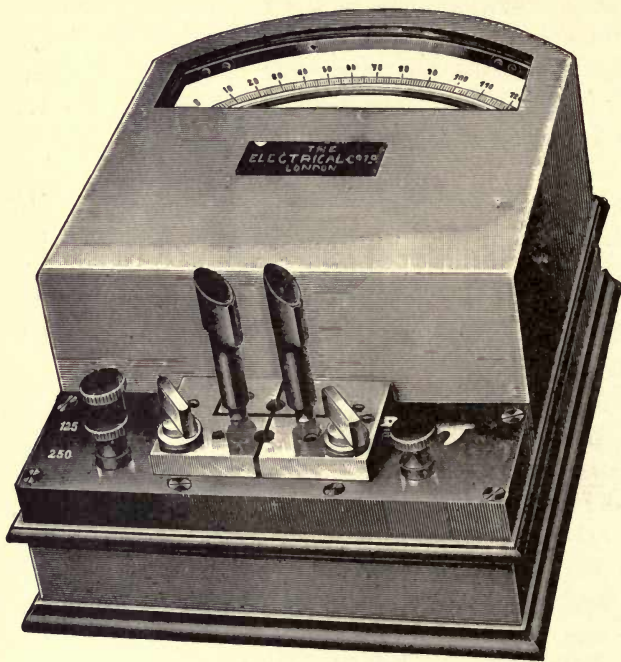

Fig. 194.—Electrical Company's Moving-Coil Wattmeter (Laboratory form)

As a rule these wattmeters can be used for two different voltages, and contain the corresponding dead resistances connected to the shunt terminals N_2 and N_3 . In this way four ranges of measurement can be obtained. The dead resistances are non-inductive, and by the employment of further resistances, higher voltages can be used. The readings of any wattmeter should be independent of any lag in phase of the current behind the potential difference.

If c = the wattmeter reading,
 ϕ = the angle of lag in the main-current circuit,
 ψ = the angle of lag in the shunt circuit,
 λ = the true watts;

$$\text{Then the true watts } \lambda = c \frac{1 + \tan \psi^2}{1 + \tan \phi \tan \psi}.$$

The wattmeter, we therefore see, will read correctly if the correcting factor

$$\frac{1 + \tan \psi^2}{1 + \tan \phi \tan \psi} = 1,$$

which is the case when $\tan \psi = 0$, or when $\phi = \psi$.

Now $\tan \psi$ gives the ratio of the reactance to the ohmic resis-

tance in the shunt circuit of the wattmeter, and is zero if the reactance is negligibly small compared with the ohmic resistance. This can only be obtained approximately, and it is clear that the correcting factor increases as $\tan \psi$ increases, *i.e.* with the increase in phase difference between the currents and voltage in the main circuit. With these watt-

meters the reactance is so small compared with the ohmic resistance that the correcting factor is negligible even with motors and transformers on open circuit. The differences for direct and alternating currents with the wattmeter are slightly more marked than in the case of the voltmeter (p. 76). Figs. 195 and 196 give an external and internal view of a wattmeter designed in this way for switch-board purposes, the calibration referring to tests with alternating currents.

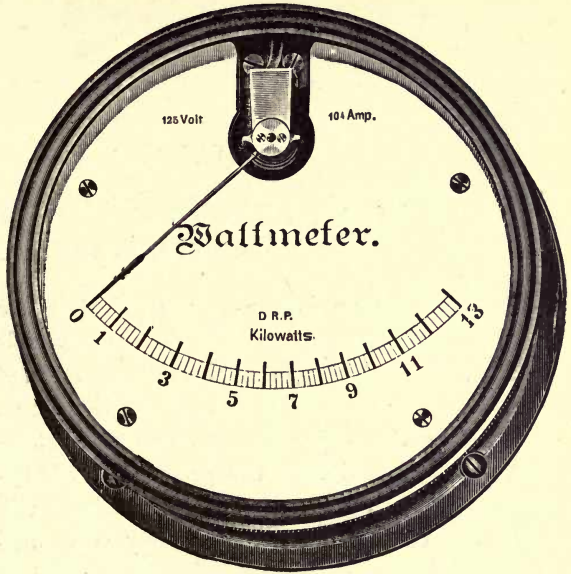

Fig. 195.—Electrical Company's Moving-Coil Wattmeter (Switch-Board type)

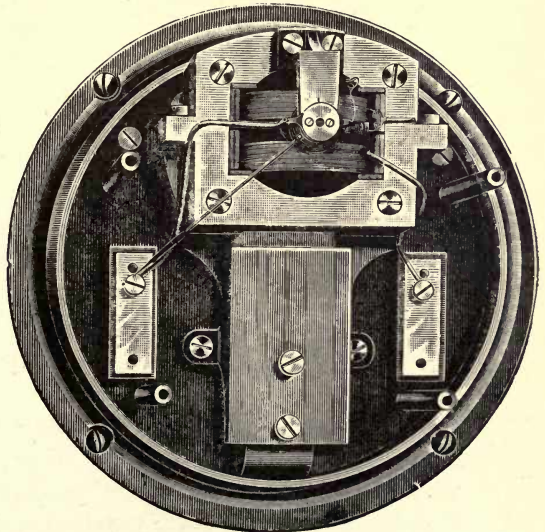

Fig. 196.—Interior, with Cover and Scale off

CHAPTER VI

RECORDING AMMETERS, VOLTMETERS, AND WATTMETERS

In the commercial supply of electrical energy from central stations to the public, Board of Trade regulations necessitate maintaining the pressure within prescribed limits. The ordinary switch-board measuring instruments—viz. the ammeter, voltmeter, and electricity meter—give *no record* as to what the pressure or current was at any time during the preceding twenty-four hours, but only what was passing at a particular instant, while in the electricity meter the total quantity or energy consumed in so many hours is recorded.

A rough record may be kept by noting down the readings of every instrument once every ten minutes, say; but such a tabulation tells the engineer very little, since manifestly both pressure and current might have fluctuated enormously between the times of observation, and such fluctuations would not have been recorded. Thus it will be seen that an instrument which will itself give a record of the value of the current, pressure, or power during every instant throughout the day is a most useful adjunct to a supply system. By the use of such an instrument a permanent record day after day can be kept of any fluctuation, with the exact time at which it occurred.

Instruments for effecting this end are called *recording ammeters*, *voltmeters*, and *wattmeters*, or often briefly *recorders*.

These are practically the ordinary instruments already described, combined with a drum rotated by clock-work, which holds the scale or chart marked by the pen-tipped pointer of the electrical part of the instrument.

They are liable, of course, to the same errors as the ordinary instruments already described which belong to the same class. It is therefore unnecessary to dilate further on such errors. In recorders, in addition to the usual errors, the friction of the moving parts being increased by the addition of the pen rubbing

on the chart, the greatest possible deflection moment or torque should be obtained so as to minimize such errors. We will now consider a few well-known forms of recording instruments of all classes.

Holden Recording Ammeters and Voltmeters

These well-known recording instruments, devised by Major Holden, R.A., and made by Messrs. Evershed & Vignoles, and by Mr. James Pitkin, London, work on the hot-wire principle, and are therefore applicable for use indiscriminately for either direct or alternating currents, being entirely independent of the periodicity of the supply.

The principle involved, which is similar to that employed in the Hartmann & Braun hot-wire ammeters and voltmeters (p. 135), is the indication of the expansion of a wire due to the heat generated in it by the passage of a current through the wire. The construction and action will be understood by a reference to fig. 197, which represents a Holden hot-wire recording voltmeter. In this, and in the ammeter of the same make, the expansion, instead of being measured directly on a long length as in the ordinary Cardew voltmeter (p. 126), is measured by the *sag* of a comparatively short portion of the platinum-silver wire *PP* (as in the Hartmann & Braun voltmeter), which is wound continuously in a series of ten turns over grooved slate cylinders *PP*, mounted on spindles which run in jewelled frictionless bearings. The ends

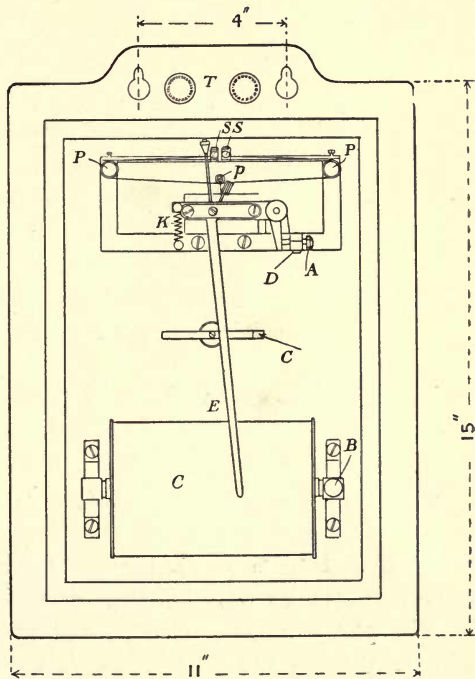

Fig. 197.—Principle of Holden Hot-Wire Recording Voltmeter

of this platinum-silver working wire, which is 0.0015 inch diameter, are clamped under and terminate at the terminal clamping screws ss, which are insulated.

The sag of the working wire is taken up by a third grooved roller *p*, which is pressed against the lower plies of the working wire by the force with which the pointer *E* and its weight attached tries to turn round on the spindle carrying it. The construction is such that the leverage at which this force acts increases as the angle of motion of the pointer increases, thereby producing an even scale of equal divisions.

The pointer *E* moves in front of a fixed rail *c* having a pin at the left-hand end, which limits its play to the left, and is bent into a *U* shape at the right-hand end, which not only acts as a stop this side but also prevents the pointer which carries the pencil or pen at its extremity from swinging about when it is at zero and the instrument is being moved about.

The scale is about 3 inches long in these instruments, reading usually in single volts from 80-120 volts or a multiple of these numbers. This is wrapped round a drum *G*, which is caused to rotate once every twenty-four hours or seven days by clock-work inside, and against which presses, very lightly, the pencil of the index pointer *E*.

To place a scale or chart in position on the drum, loosen the screw *B* which clamps the drum axle, and turn the drum until the chart clip (not seen in figs. 197 and 198) is in front. Remove the clip and replace the chart, adjusting it relatively to the clip so that there are twenty-four hours clear on the drum. The drum is then adjusted so that the pencil index reads at the right point on the time-line, and its axle is then reclamped.

The pen should be refilled and the clock wound up each day when replacing the chart, though the clock will usually run for seven days, if necessary, without rewinding. Further, it is necessary that these instruments should be hung vertically to ensure that the pen presses properly on the chart, while the upper edge of the case must be set horizontal to ensure correctness of reading.

When the working wire gets damaged or breaks, the restringing of a wire is effected as follows:—The case is first removed by taking out the hinge pins and the screws in the hinged stay on the right-hand side, and every bit of the old wire is removed, particularly that under the terminal clamping screws ss. Next unscrew *D*,

and screw in A until the top of the small roller p is in a straight line with the lower edges of the rollers P P. Then clamp one end of the new working wire under the washer of the lower screw S, and wind clockwise in the grooves provided in the rollers P P and

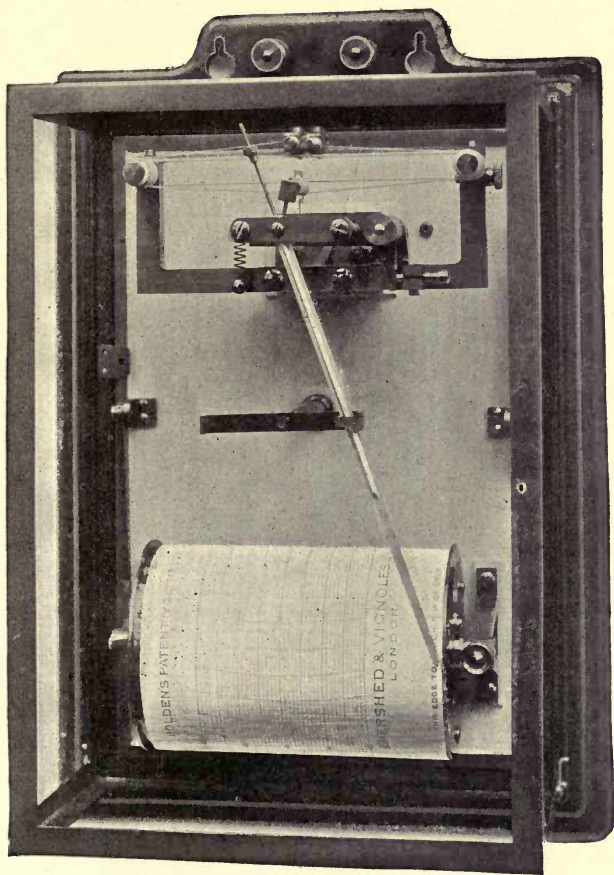

Fig. 198.—Holden Hot-Wire Recording Voltmeter

pulley p , finishing off at the upper screw S. Lastly, replace the case, levelling it as above mentioned, and adjusting the voltmeter at the desired part of the scale by screwing the adjusting screw A; finally tighten the clamping screw D.

This method of construction has the great advantage that the whole length of the wire is active or utilized, so that the resistance is high and is all operative. Further, since the mechanical force

working the pen index is proportional to the number of turns of wire, the force used can be very large.

The instrument is dead-beat in its action, and up to 300 volts the whole of the wire is utilized, there being no idle extra resistance as in many other instruments.

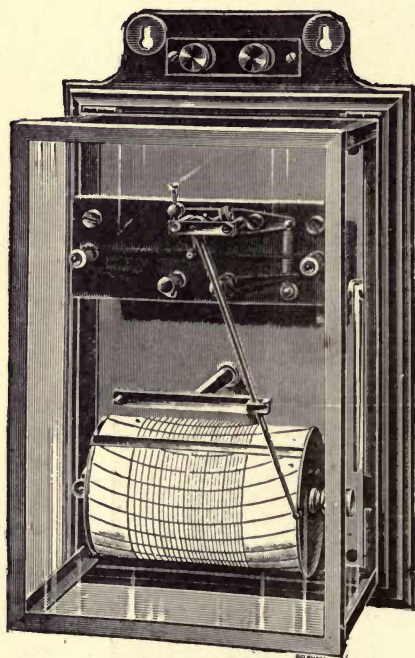

Fig. 199.—Holden Hot-Wire Recording Ammeter

0.3 volt. The sag is taken up by the pointer and its attached weight in the same way as before, and the pencil index describes a continuous line on the chart, which is divided by vertical and horizontal lines into time and volts (or amperes).

Kelvin's Recording Ammeters and Voltmeters

These instruments are similar in construction to the ordinary permanent-magnet moving-coil instruments, and are intended for direct currents only. The construction of the instrument is very simple, and will be understood from a reference to figs. 200 and 201, which represent a recording voltmeter of this type.

Fig. 198 shows the general external view of a Holden recording voltmeter.

In the case of the recording ammeter, a general view of which is shown in fig. 199, the working wire is wound somewhat differently. As seen in the figure, it terminates at two fixed grooved terminal studs in the slate back, but passes round the grooved rollers at the sides, consequently the sag of the top set of parallel plies now is employed for indicating, and the current passes through all these wires in parallel, giving a fall of potential between the terminals at maximum reading of about

The moving coil, suitably wound, is pivoted between the poles of the circular-ring permanent magnets seen in fig. 201.

These are carefully "aged" and magnetized so as to be strong and permanent.

The pen, or inker, attached to the spindle and coil, rests against the paper with a small component of its own weight, sufficient to give a clear marking without introducing a frictional error.

The clock-work, which drives the drum once round either every twelve or twenty-four hours, has a non-magnetic lever movement, and is free from back-lash—a common fault with clocks of this nature. It is attached to the base of the instrument by a hinge, enabling it to be drawn outside the case when changing the chart on its surface. When pushed back against a stop it is in its working position. The scale is an extremely open one at the working part, and is marked in one-volt divisions.

Recording Ammeters and Voltmeters

The instruments of this class, made by Messrs. Everett, Edgcombe, & Co., of London, for use with direct currents, are constructed on the well-known moving-coil D'Arsonval principle, which it is unnecessary to explain.

The marked distinction between this and other similar recording instruments lies in the form of pen used, which consists

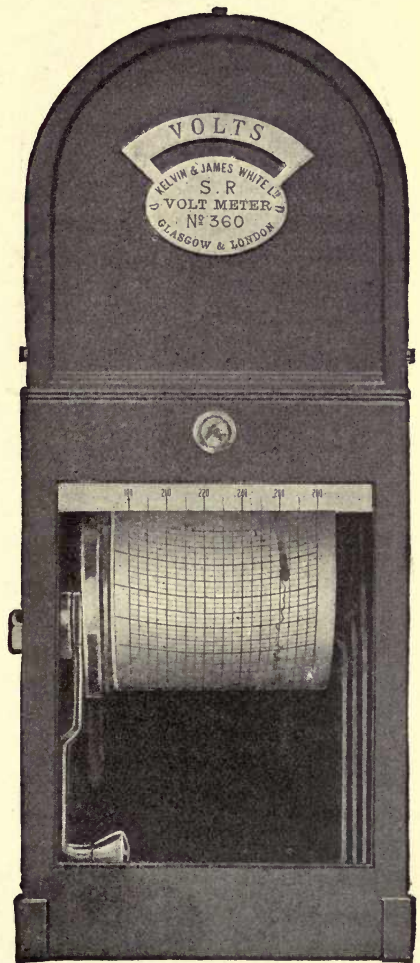

Fig. 200.—Kelvin Permanent-Magnet Moving-Coil Recording Voltmeter

of a small vessel, large enough to contain ink sufficient for a week's run.

The ink is drawn up and fed on to the paper by means of a small strip running down to the bottom of the vessel.

The advantage of this arrangement is that the pen does not become clogged when in actual use, and that it can readily be cleaned should the ink dry up through long disuse.

Further, the ink has no tendency to spill, and a thin even line is traced whether the pen is full or nearly empty.

The pen is attached to a light aluminium arm, hinged at its upper end, so that the pressure of the pen on the paper can be regulated to a nicety.

Both recording ammeters and voltmeters are provided with a special dash-pot to make them dead-beat, which is absolutely essential for some purposes — as, for instance, traction circuits.

The paper charts are 4 inches wide, which results in a very open scale being obtained, and they can be used in continuous rolls lasting seven days or for twenty-four hours only.

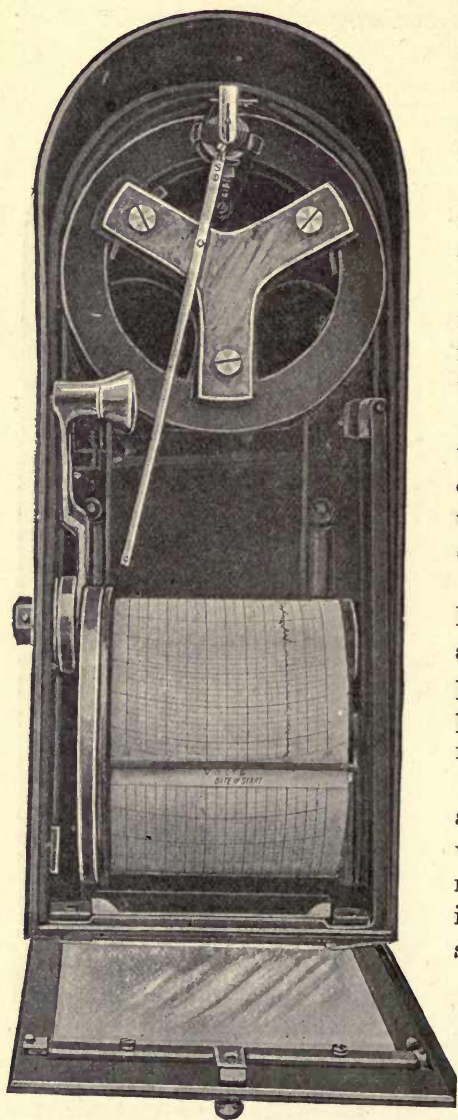

Fig. 201.—Kelvin Permanent-Magnet Moving-Coil Recording Voltmeter (case off)

Harrison's Recording Voltmeter

This instrument is intended for use on direct-current circuits, and is shown in fig. 202.

It consists of a soft-iron frame of small dimensions, and shaped similarly to the field-magnets of a single magnetic-circuit dynamo.

The limbs are wound with two coils of fine insulated wire connected to the two small terminals seen at the top. Between the curved pole-pieces is pivoted a soft-iron armature, to which is attached the pen pointer. The controlling force is gravity, and it is therefore always constant.

It will be observed that the design of the instrument is such, that a large force is obtained for actuating the inking pen-pointer without much energy being absorbed, whereby the common fault in recording instruments, namely, the tendency to stick on account of the pressure of the pen on the paper, is practically entirely eliminated.

The pressure of the pen is adjusted by moving the drum holding the chart, and this gives a very excellent adjustment.

The amount of iron in the moving parts is extremely small, thus reducing hysteresis to a minimum. Further, these instruments are sensitive enough to record a variation of 0.3 per cent, owing to the somewhat large amount of power actuating the pen relatively to the small amount of electrical energy consumed.

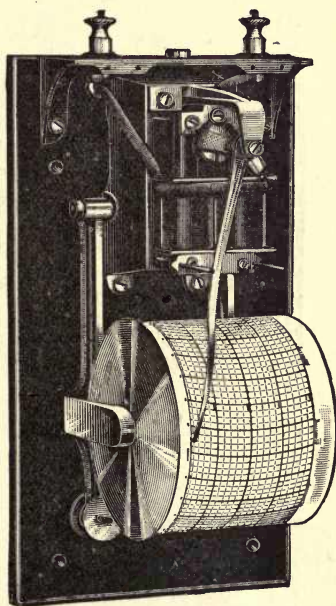

Fig. 202.—Harrison Recording Voltmeter
(case off)

Harrison's Recording Ammeter

This instrument is of the electro-magnetic moving iron needle class, having a gravity control.

Fig. 203 shows the construction, which is very simple, and is as follows:—

The working solenoid, or actuating coil, wound with thick wire, has a hollow rectangular interior, of which the longest dimension

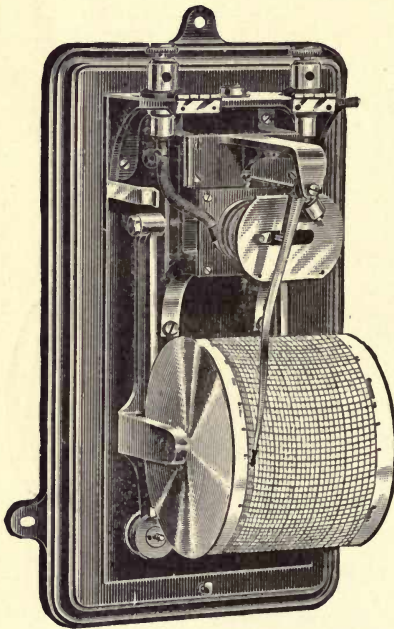

Fig. 203.—Harrison Recording Ammeter (case off)

is horizontal, as seen in the illustration. A thin triangular-shaped piece of soft sheet-iron is bent at right angles, and inserted in the hollow of the coil so that the base or wide part is close to the left-hand short vertical side of the hollow, and the apex or point of this triangular piece extends along one of the long sides of the interior. The moving system consists of a horizontal spindle pivoted just above the coil, in jewelled centres, and carrying the inker pointer.

To this pointer is attached, a little below the spindle centre, a small soft-iron rod capable of moving on the pointer from one end of the slot to the other. In the zero position of

the pointer, for no current, the moving rod and fixed base of triangular plate are parallel and close together, and extend the width of the solenoid. When a current flows, both these develop similar polarity at the same end, and repulsion ensues to an extent depending on the current strength.

The tapered fixed plate causes the pointer to move equal distances approximately for equal variations of current, as its effect on the moving iron diminishes as the latter approaches the apex.

The Electrical Co.'s Recording Induction Wattmeter

This instrument is almost precisely similar to the induction wattmeter described on p. 165.

The only difference being in the addition of two drums, A and E,

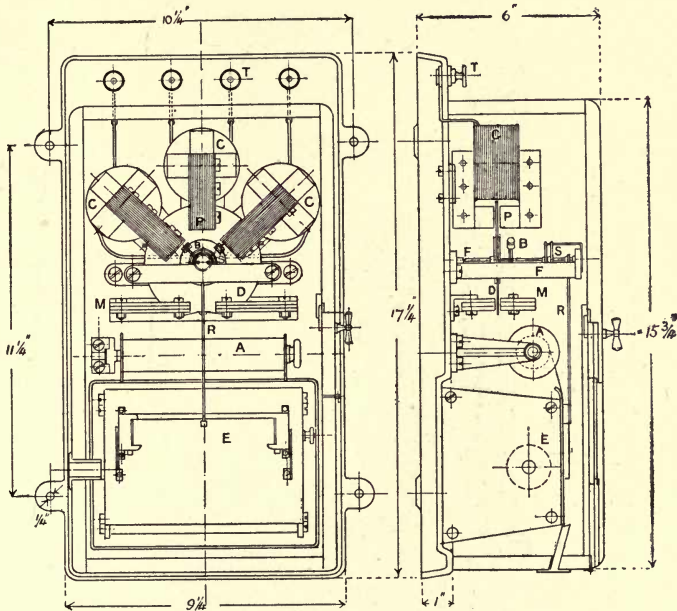

Fig. 204.—Electrical Company's Recording Induction Wattmeter (front and side elevation, with cover removed)

fig. 204, of which E is driven once round by clock-work in twenty-four hours.

The pointer R of the wattmeter terminates in a pen which records a continuous line on a chart or strip of divided paper about 17.5 inches long, with its ends gummed together, and passing over the two drums A and E.

The actuating portion of the instrument otherwise is similar to the wattmeter. A metallic disc D is carried on a horizontal spindle F running in jewelled centres.

To F is attached the pointer R, balance-weights B, and controlling springs s.

The pivoted disc moves in the narrow gaps between the poles P of three laminated electro-magnets c. The centre coil is wound

with thick wire and constitutes the current coil, while the side coils are wound with fine wire and are connected across the mains.

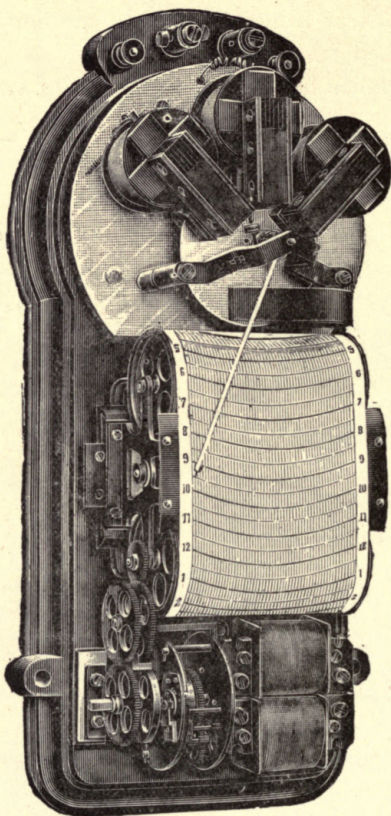

Fig. 205.—Electrical Company's Recording Induction Wattmeter (interior, with case removed)

The poles are fitted with the metal screens described on p. 113.
Fig. 205 shows an internal view of a recording induction wattmeter of this make with cover removed, from which the construction will be clearly seen.

CHAPTER VII

MISCELLANEOUS STANDARD AND OTHER INSTRUMENTS

The present chapter will be devoted to the description of a few of the principal types of *standard* measuring instruments suitable for calibrating the ordinary forms already considered. The question of obtaining accurate and reliable standards by which to check other instruments is one of great importance, since not only does it secure uniformity amongst these instruments, each being able to reproduce the readings of any other, but it also secures constancy, the readings of any standard remaining invariable with time. Constancy is far easier to get than uniformity, which cannot yet be said to have been obtained.

Zero instruments are much to be preferred to those in which deflections have to be read, and in all cases standards working on electro-magnetic principles should be permanently fixed in positions where the permeability of the surrounding media is likely to remain quite constant. This will be one step towards the maintenance of constancy.

Lord Kelvin's Standard Electric Balances

These instruments, made by Messrs. Kelvin and James White of Glasgow, are intended as standards for the accurate measurement of both direct and alternating currents of electricity, and are at once delicate and ingenious in construction.

There are some ten different types of these instruments, alike in principle, but differing slightly from one another in form, depending on what the instrument has to measure. Some of the types are intended to measure pressures in volts, current in amperes, and power in watts, while others are suitable for either one or two only of these purposes.

The principle on which they work is the electro-dynamical action of fixed and movable coils, which are carrying the same or different currents on one another.

In each of the balance instruments, except the kilo-ampere balance, there are two flat movable circular coils or rings, E and F (fig. 206), each actuated by two fixed coils, A C and B D respectively, all with their planes approximately horizontal.

The two movable coils are attached, one at each end of a horizontal balance arm GH, which is supported by two trunnions, each hung by an elastic ligament, L_1 and L_2 , of fine wire, through which the current passes into and out of the fine-wire coils E and F.

The relative, but not necessarily the actual, polarity of the coils is shown in fig. 206, and hence in any case the right-hand end of the balance arm moves up and the left-hand end down. Further, it will be observed that there is repulsion between A and E, and

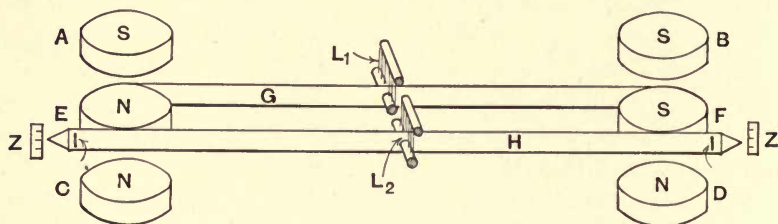

Fig. 206.—Principle of Kelvin Balance

also between F and D, owing to adjacent faces being of like polarity, while there is attraction between E and C, and between B and F, owing to the opposing faces of the coils having unlike polarity.

Hence the motion of E and F is due to the sum of all these effects, which are produced by suitably connecting all the coils in series with one another.

The current flows in opposite directions through the two movable coils, so as to practically annul disturbance due to horizontal components of terrestrial or local magnetic forces. The mid-range position of each movable ring, when between two fixed ones, is in the horizontal plane nearly midway between these latter, and is a position of minimum force. The "sighted position", for the sake of stability, is above it at one end of the beam and below it at the other, in each case being nearer to the repelling than to the attracting ring by such an amount as to give about one-fifth per cent more than the minimum force.

The so-called "sighted position", above mentioned, is really the zero position of the balance arm with its moving coils when adjusted, and for no current passing.

The balancing, or bringing back of the moving beam to the index zero when a current causes a deflection, is performed by means of a weight which slides on an approximately horizontal graduated arm attached to the balance, and seen in fig. 207.

The slipping of the weight and carriage into its proper position on the scale to give exact balance, *i.e.* to bring the index pointer I (fig. 206) to the zero of the index scale Z, is performed by means of a self-releasing pendant. This is provided with a vertical arm intended to pass up through the rectangular recess in the front of the weight and carriage, and hangs from a hook carried by a slider, which slides on a rail fixed to the sole-plate of the instrument. The slider is pulled in either direction by two silk cords, as seen in fig. 207, passing through holes in the glass containing-case.

A trough will be observed fixed to the right-hand end of the moving coils, into which a proper counterpoise weight, with a pin through it, is placed. This is for the purpose of balancing the carriage and its contained weight when at zero on the horizontal movable scale.

For the fine adjustments of the index zero a small metal flag is provided, as in an ordinary chemical balance, and it is actuated by a fork, having a handle below the case outside, as seen in fig. 207.

In addition to the finely-divided moving aluminium scale attached to the arm H (fig. 206), there is a fixed inspectional scale just behind, visible above the former scale, and which shows approximately enough for most purposes the current strength.

The notches on the top of the moving scale show the exact position of the weight corresponding to each of the numbered divisions on the fixed one, which practically annuls errors of parallax due to the position of the eye.

The position of the pointer of the carriage, when between two divisions on the fixed scale, can be estimated accurately enough for all practical purposes.

When, however, the greatest accuracy is desired the reading on the moving scale is taken, and the doubled square root of this will be the exact reading on the fixed scale.

Four pairs of weights (sliding and counterpoise), of which the carriage and its counterpoise constitute the first pair, are provided with the instrument, the carriage always remaining on the rail. These weights are adjusted in the ratios of 1 : 4 : 16 : 64, so that each

pair gives a round number of amperes, volts, or watts either in multiples or decimal subdivisions of these on the fixed scale.

In using the balance, after carefully levelling it by means of the spirit-level and levelling-screws with which it is provided, the pair of weights (sliding and counterpoise), requisite for giving the maximum reading to be obtained as specified by the makers, are first inserted in their proper places, and the balance is then "set" to zero, by sliding the carriage to 0 on the moving scale by pulling the cords. The flag is then turned to one side or the other until it is found that, with no current through the coils, the index *I* (fig. 206) points to zero on the index scale *z*.

A current can now be measured by sliding the carriage to such a position that *I* floats to the zero again; the reading of the carriage pointer on the scales will then give the quantity measured, and a lens is provided for reading the finely-divided scale.

Having now discussed the general principles underlying the construction and action of the Kelvin balances, it will be advisable to consider two or three types of these very commonly met with in practice as standards.

Kelvin's Standard Centi-Ampere Balance

This instrument is intended for measuring currents from 1 to 100 centi-amperes, though the best of its range is from 0.025 to 1 ampere. All the six coils are composed of fine wire, connected in series between the two terminals seen under the front edge of the sole-plate in fig. 207, which is a general view of the actual instrument with glass protecting-case removed. The terminal resistance of the balance is about 50 ohms.

Between the left-hand terminal and the handle which actuates the flag, is a disc, fixed to a shaft which can raise a tripod lifter, and which can be prevented from turning by a pin attached to the chain shown. By turning this disc, the movable beam can be raised off the supporting ligaments, and clamped when the instrument is moved at any time.

The centi-ampere balance can also be used as a voltmeter to measure voltages from 10 to 400 volts by employing a box of resistances up to 1600 ohms, made of manganin or platinoid, which are connected in series with the instrument. The terminals of the combination then become that of the standard balance. When used

for volt measurements, a thermometer is provided for measuring the temperature of the coils. This is done by inserting it in a hole made for the purpose in the centre region of the coils.

The effect of change of temperature in the coils of the instrument and of the extra resistance can thus be allowed for when great accuracy is desired.

In the use of the balance as a voltmeter, it is best to employ the larger extra resistances so as to have the lighter weights in the sliding carriage.

The extra resistances above referred to are usually four in number, three of which, in the set for use with the centi-ampere

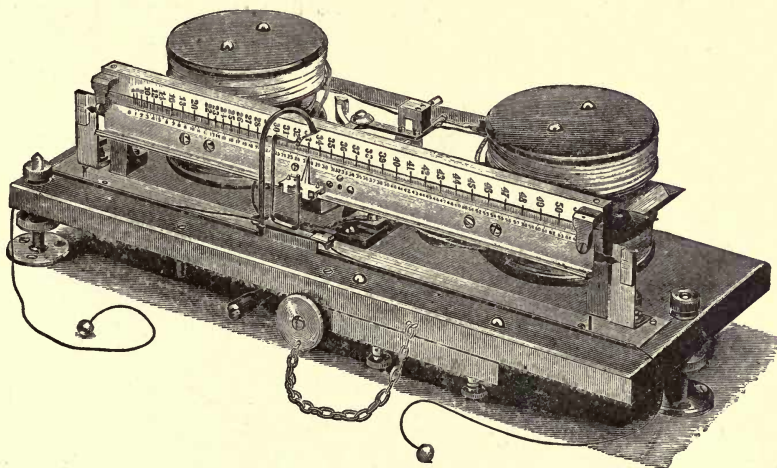

Fig. 207.—Kelvin Centi-Ampere Balance

balance, are each 400 ohms, and the fourth is less than 400 ohms by the resistance of the coils of the balance itself at a certain specified temperature.

In the set employed for the composite balance when measuring voltage or power, two are 200 ohms each, the third less than 200 by the resistance of the moving coils only, and the fourth less than 200 by that of all the coils of the balance in series.

In all cases these resistances are doubly wound so as to be non-inductive, and are made of wire having a negligible temperature coefficient of variation of resistance, wound on suitable frames so as to give a maximum amount of cooling surface.

The containing case is perforated so as to give enough ventilation and allow any heat to escape.

The lowest resistance is intended to be included by itself in the circuit of the balance, when the lowest potentials are being measured, and in series with one or more of the others, when the potential is so high as to give a stronger current than can be measured with the largest weight on the carriage.

Kelvin Standard Composite Balance

This instrument can be used as a wattmeter, voltmeter, centi-ampere balance, and hekto-ampere balance for currents from 0.2 to 500 amperes. It is similar in form to the preceding centi-ampere balance, but the pair of fixed coils at one end of the beam are

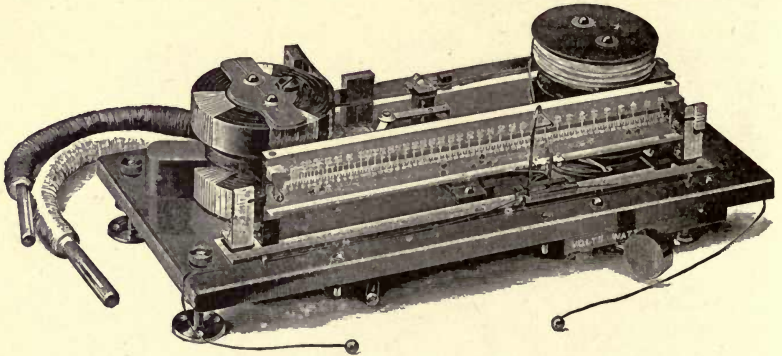

Fig. 208.—Kelvin Composite Balance

made of a rope of separately insulated copper wires, similar to that used for the coils of the hekto-ampere balance. This is in order to prevent the inductive action (when alternating currents are being measured) from altering the distribution of the current across the transverse section of the conductor.

Fig. 208 shows the general appearance of the composite balance with cover removed, the two fixed thick-wire coils being on the left and the fixed fine-wire coils on the right, the movable coils being wound with fine-wire. Separate terminals are provided for the rope coils at the back, and for the fine-wire coils in the front (on the right). A switch, which allows the movable coils either to be included in the circuit by themselves or in series with the fixed fine-wire coils, is attached to the under side of the sole-plate of the instrument, and is seen on the right.

When the handle of this switch is turned to "watt", the mov-

able coils alone are in circuit across the small terminals, giving a resistance of about 12 ohms; but when the handle is turned to "volt", both the movable and the fixed fine-wire coils are in circuit across these terminals, giving a resistance of about 30 ohms.

To enable the composite balance to be used as a direct-reading wattmeter or voltmeter, a separate anti-inductive resistance of platinoid or manganin wire subdivided into four coils is provided. These are connected in series with the small terminals, and are used in the manner set forth in the directions sent with the instrument for obtaining a certain particular constant. In the case of the voltmeter, if R = the total resistance of the coils of the instrument + that in series with them, and C = current in amperes flowing through it, which literally the instrument measures, then the voltage at the terminals of the combination is $V = C \cdot R$.

The extra resistances are so arranged that the balance reads a round number of volts per division.

When used as a wattmeter, the switch is put to "watt", and the small terminals in series with a suitable extra resistance, connected across the mains.

The rope coils are connected in series with one of the mains.

If now c = current in the fine-wire circuit,
 C = " " " main "
 R = resistance of the fine-wire circuit;
 Then $W = VC = c \cdot R \cdot C$ watts.

The weights and extra resistances are adjusted to give a round number of watts per division.

In the use of the balance as a centi-ampere meter, the switch is turned to "volt", thus putting the movable and fixed fine-wire coils in series, and the measurements can then be taken as already described (p. 186).

When used as a hekto-ampere meter, the switch is put to "watt", and the thick coils connected in series with the main circuit. A measured current is then passed through the fine-wire coils in such a direction that the right-hand end of the beam is repelled upwards.

The measured current corresponding with the constants sent out with the balance = 0.25 ampere, but any other current convenient can be used, remembering that the constants vary inversely as the current through the fine-wire moving coils.

The other types of balances are mostly intended for special ranges of measurement.

In the kilo-ampere balance, the whole current passes through a single fixed ring, and divides through two halves of a movable ring, which are urged one up and the other down by the resulting force.

Potentiometer Standard Measuring Instruments

This class of instrument is essentially a standard one, and possesses many advantages over several other standard instruments performing similar functions.

The system of measurement embodied in the potentiometer was originally suggested by Professor J. A. Fleming, F.R.S.; but its

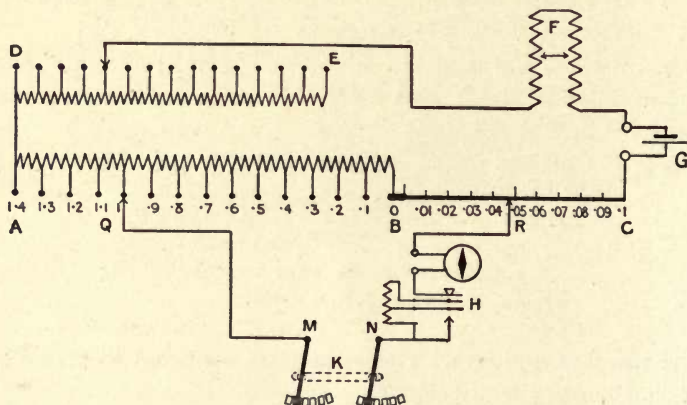

Fig. 209.—Diagrammatic View of Crompton Standard Potentiometer

application in a practical form is due to Lieut.-Col. R. E. B. Crompton, C.B., *Electrical Engineers* (Vol.).

The potentiometer enables extremely accurate determinations to be made of voltage, current, electrical power, and resistance, with considerable ease and rapidity. All readings are in terms of the standard of E.M.F. universally used, namely, that of the Clark cell or its modifications.

One important advantage lies in the fact that the instrument itself may be placed in any convenient position, if necessary, at a distance from the circuit in which the measurement is taking place. This is possible because the length, size, and resistance of the wires

which go to the potentiometer are of no consequence, as they carry no current at the moment of observation.

There are several makes or types of potentiometer, among which may be mentioned those made by Messrs. Nalder Bros. & Co., R. W. Paul, Crompton & Co., all capable of effecting the same object; but it will suffice for our purpose if we describe one of the oldest and possibly the best-known forms, though possessing the latest improvements, namely, that made by Messrs. Crompton & Co., of Chelmsford.

The construction of the potentiometer itself is shown diagrammatically in fig. 209, for which, with the two following illustrations and the description, the author is indebted to the makers.

The calibrated wire is arranged in fourteen coils called potentiometer coils, lettered AB, and a straight section BC, called the scale wire, the resistances of the several coils and of the straight section being equal.

One sliding contact Q moves over the terminals of the fourteen coils, and another R along the straight wire. The reading of the instrument in the position shown is 1.046.

The pairs of points whose potential differences are to be compared are connected to the blocks of the double-pole switch K, whose levers MN connect them, one pair at a time, to the sliding contacts QR through the galvanometer.

The galvanometer key H is arranged to complete the circuit through two resistances, which are short-circuited in succession as the key is depressed. The current required is derived from a small

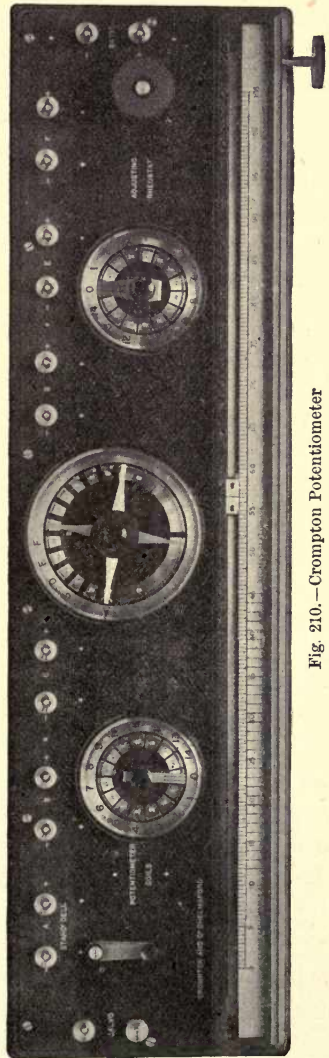

Fig. 210.—Crompton Potentiometer

secondary battery *G*. An adjustable resistance, consisting of a set of coils *D E*, and a continuous rheostat *F*, is placed in the circuit. By adjusting these the resistance of the circuit and the current passing through it from the secondary cell, and consequently the fall of potential along the scale wire, can be continuously altered. The operator is then able to obtain a galvanometer balance against a standard cell when the reading of the sliders is that of the known E.M.F. of the cell at its actual temperature.

If, for example, the temperature of the cell be 15° , so that its E.M.F. is 1.4340 volts, the sliders may be set to that reading, and the galvanometer brought to zero by adjusting the resistances *D E* and the rheostat *F*. When this has been done the scale readings

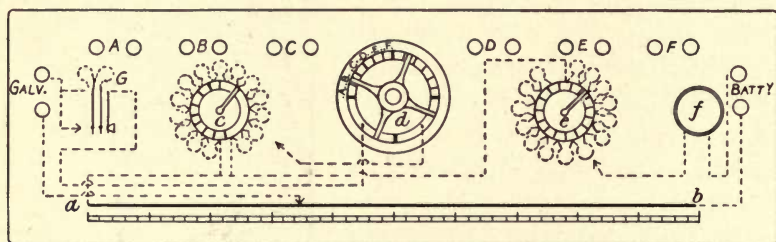

Fig. 211.—Connections of Crompton Potentiometer

at all points are direct readings in volts. A general view of the potentiometer is given in fig. 210, and a diagram of its internal connections in fig. 211. Here *ab* is the scale wire; *c* the set of equal potentiometer coils in series with it; *d* is the double-pole switch connecting the six pairs of terminals *A B C D E F* in succession to the slide contacts; *e f* are the resistance coils and rheostat respectively, and *G* is the galvanometer key. All the moving contacts are under glass, and the coils and the scale wire are inside the box. The box itself is completely closed, but the inside can be inspected by removing the sliding bottom.

Nearly all the measurements made involve the use of a standard cell, and one pair of terminals, the pair *A*, is assigned to its connections to save confusion in working.

Fuses of fine wire are inserted at all terminals except those for the galvanometer, to save the instrument coils in the case of an accidental connection to a source of high pressure.

Two scales are engraved for slide-wire readings. One is a series of even divisions from 0 to 105, the resistance of the scale wire

between 0 and 100 being the same as that of each potentiometer coil.

It has been found convenient to be able to take readings a little beyond the 100 mark without having to move the potentiometer coil switch, the scale being extended to 105 to admit of this.

The other scale gives the value of the Clark cell at different temperatures, and is used in the following way:—

The potentiometer coil switch is set to 14, and the slide to the temperature of the Clark cell taken from the thermometer attached to it. The potentiometer reading is then the correct value in volts of the Clark cell at that temperature.

By adjustment of the rheostat, the galvanometer is balanced, and when this has been done the current in the potentiometer wire is such that readings at all points give correct value in volts, and the instrument becomes therefore a direct-reading voltmeter. Its maximum range is then 1.5 volts, reading in thousandths of a volt, and by inspection to ten-thousandths.

The potentiometer itself is solely a pressure measurer, but by combining it with its accessories, current, power, and resistance can just as easily be measured.

Any pressure less than 1.4 volts can be applied directly to and measured by the potentiometer; all higher pressures have to be measured through the medium of what is termed a "volt box", which consists of resistances bearing exact ratios to one another. Consequently the voltages at their terminals will be in similar proportion, and a known fraction of the total voltage to be measured is therefore measured on the potentiometer, whence by multiplying up the value of the total voltage is obtained.

Currents are measured by the direct application of Ohm's law, for since by this we have

$$\text{voltage} = \text{current} \times \text{resistance},$$

the current to be measured is passed through a standard low resistance, capable of carrying it easily, and of known value, when by measuring the potential difference across this resistance by the potentiometer, the value of the current producing it is at once known. In a similar way two resistances are compared, and the value of the unknown obtained by comparing the potential differences across them, which must not be greater than 1.4 volts for the

same current passing through them. In this case the volts across either are directly \propto to the resistance.

Alternating-Current Induction Phasemeter

In alternating-current work, whether single or polyphase, it is often very convenient and desirable to know the phase difference between current and pressure, for on this depends the "power factor" of the circuit, and, in addition, the "wattless component"

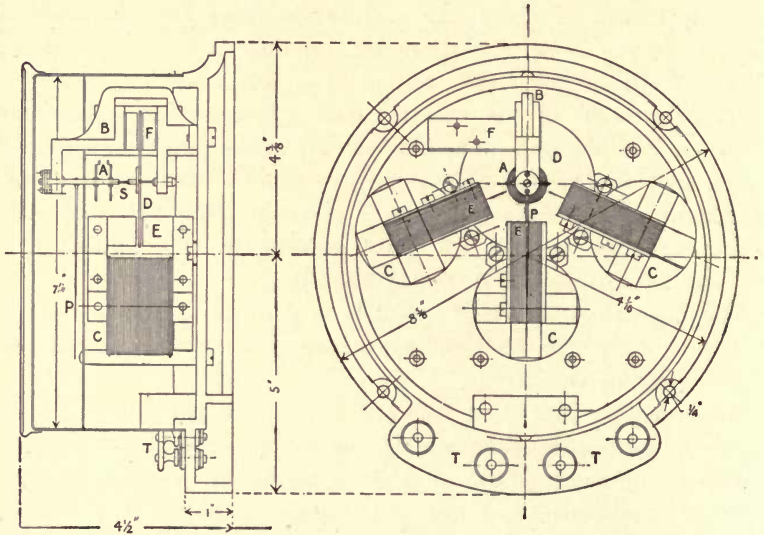

Fig. 212.—Electrical Company's Induction Phasemeter (side and front elevation)

of the main current. This latter it is of course important to reduce to a minimum, not merely because it loads up the generators and does no useful work, but because it is productive of a low-power factor, *i.e.* the ratio, true watts \div apparent watts.

The phasemeter now under consideration, made by the Electrical Co., Ltd., of London, is an instrument for measuring directly the value of the wattless current in an inductive alternating-current circuit.

In construction it is very similar to the instrument depicted in fig. 165, but its internal arrangements are, in the side and front elevational drawings, shown in fig. 212, and consist of a light aluminium or copper disc D, pivoted on a horizontal spindle S between jewelled centres.

This disc is acted upon by two magnetic fields EEE, energized

by the coils CCC, one due to the main current in the outside pair of coils, and the other to the potential or shunt current in the centre coil only, which respectively flow through the thick and fine wire coils.

Then, as in the case of the Ferraris instruments (p. 118), if there is any phase difference between pressure and current, a rotatory magnetic field is produced. This will cause the disc D to turn either to the right or to the left, according to whether the current leads in front or lags behind the potential difference.

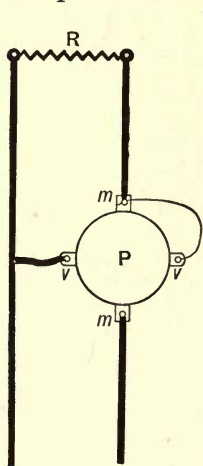

Fig. 213.—Connections of Phasemeter to Two-Wire Circuit

This torque is balanced by that of two hair-springs A, so that a pointer P attached to the disc D is deflected through a certain angle, depending upon the amount of phase difference between the current and pressure. The motion of the pointer P is damped by the Foucault currents induced in D, due to the powerful magnetic field projected through D between the poles of a permanent magnet F, which embrace D. The spindle s

and its fittings are carried by the bracket B as shown. The magnetic iron circuit E of the coils C is well laminated to reduce loss due to hysteresis and eddy currents.

- If v = potential difference between two mains,
- A = current flowing in one of the mains,
- θ = angle of phase difference between current and pressure,
- K = a constant;

Then we have that the turning moment

$$D = K A v \sin \theta ;$$

and if the instrument is used on a circuit of constant voltage, then

$$D = K A \sin \theta .$$

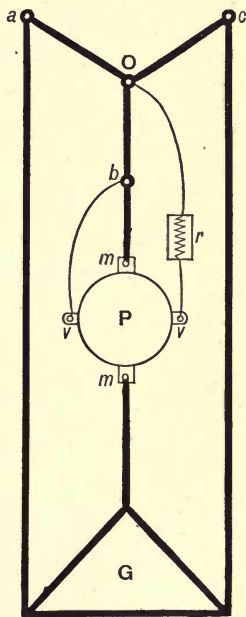

Fig. 214.—Connections of Phasemeter to Three-Phase Circuit

The product $A \sin \theta$ is the *wattless component* of the main current, and is indicated in amperes by the phasemeter. Fig. 215 shows the general view of a phasemeter intended to carry *main* currents up to 50 amperes, and to indicate *wattless* currents up to 35 amperes.

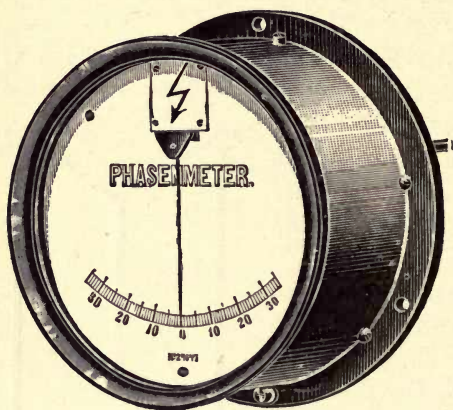

Fig. 215.—Electrical Company's Induction Phasemeter

As seen, the zero is in the centre, so that according to whether the current leads or lags, so the deflection is to one side or the other.

The method of coupling a phasemeter P up in a two-wire circuit is indicated in fig. 213, where *vv* are its pressure and *mm* its main terminals, R being the load, inductive or otherwise.

In the case of polyphase circuits, the phasemeter is connected to the *neutral point* of the three-phase windings. If there is no neutral point, one must be made by means of a neutral-point resistance.

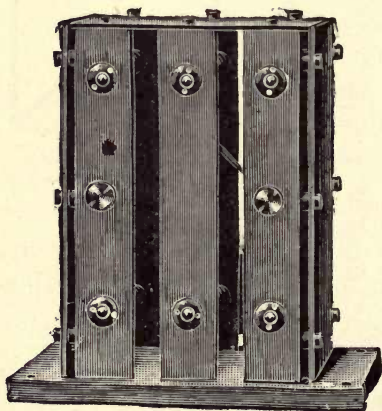

Fig. 216.—Neutral-Point Resistance for Electrical Company's Induction Phasemeter

Fig. 214 shows the connections for a three-phase circuit, in which the closed method of generator winding G is employed. A neutral point O is created in the neutral-point resistance *oa*, *ob*, *oc*, and the pressure terminals *vv* of the phasemeter P joined across one of the sections *ob* through a non-inductive resistance *r*.

The general form which this neutral-point resistance takes is shown in fig. 216. It is built in three sections, ample scope being provided for heat radiation. They are made for pressures up to 3000 volts or so, and the phasemeters themselves for currents of upwards of 1000 amperes.

These instruments are, of course, affected by variation of periodicity, and if calibrated at one periodicity will only be accurate at that.

Campbell's Frequency-Teller

This is an instrument for measuring the *frequency*, or *periodicity* of any alternating current in a circuit, enabling the users of alternating-current electro-motors to see whether they are being supplied with current at the periodicity for which the motor was built, a matter of considerable importance for the efficient operation of such machines.

The principle of action and construction is very simple, and will easily be understood from the diagrammatic sketch shown in fig. 217.

It consists of a wooden base B supporting a containing-case I, which contains the working parts. These consist of a tolerably long thin metal strip or tongue T', attached at its lower end to a metal rack R.

Gearing into R is a pinion P, actuated by the spindle A, which passes through the case I, and can be turned by the milled head N.

To R is also attached a smaller rack *r* gearing into the pinion *p*, to the spindle of which is rigidly attached the hand H.

A coil C of small insulated copper wire surrounds a plate core K of soft charcoal iron, and is connected, as shown by the dotted lines, in series with a glow-lamp and its holder L between the two terminals TT of the instrument.

The core K is separated from T' by a short air-space, and is carried at the end of a flat lever E, of vulcanized fibre, which can turn about the fulcrum M. By turning the head *n* and its screw D the system EK can be moved so that K overlaps T' more or less, the spring *s* always keeping E up against the end of D.

As N is turned, the strip T' and rack R move up or down lengthways in guides, the upper one of which, G, is hollowed out so that the strip T' vibrates from the upper edge of G, under which it is fairly tightly clamped, though able to slide up or down. The action of the instrument is as follows:—

An 8 C. P. glow-lamp (for 100 volt circuits), or 16 C. P. lamp (for 200 volt circuits), is inserted in the holder L, and the terminals TT connected across the circuit at any convenient point.

An alternating current now flows through C and causes T' to

vibrate in a plane perpendicular to the paper. N is then turned, thereby also turning the hand H over the dial (not shown) until the instrument gives a sharp jarring noise. This point is very evident and quite unmistakable, and is due to the tongue T' vibrating at the same rate as the alternating supply reverses, *i.e.* the

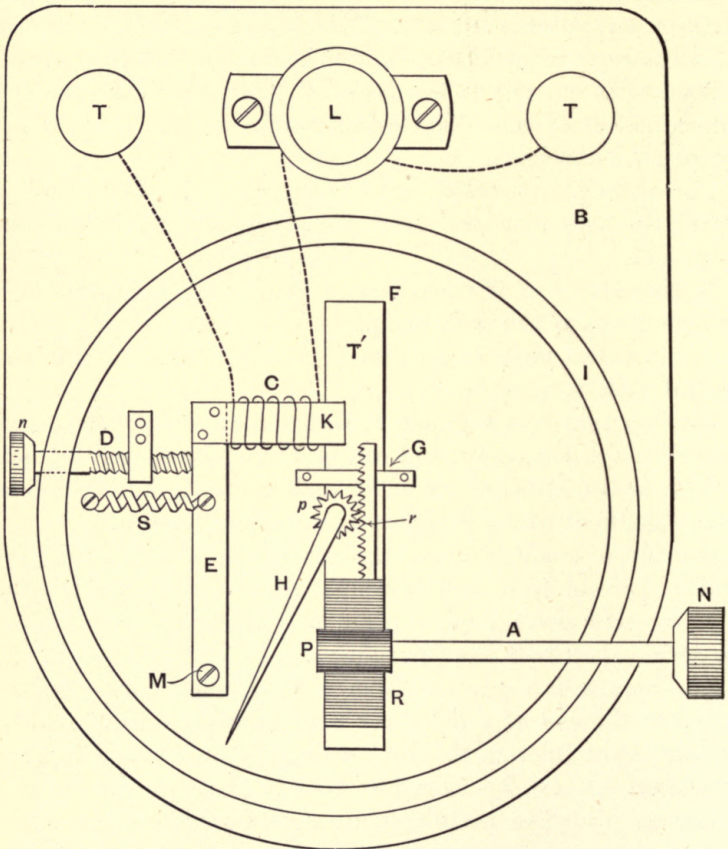

Fig. 217.—Principle of Campbell's Frequency-Teller

period of natural vibration of T' , which increases as its length increases, coincides with that of the current in time. The position of the hand H on the scale then indicates this periodicity.

For great accuracy the instrument should be read forward, *i.e.* the hand H should be brought *up* to the frequency, and *not down* to it.

The head n is for adjusting the sensitiveness of the "teller".

Screwing it out makes it more sensitive, so that it will only "speak" over the range of half an alternation of current if required, but it is then not so loud. For low frequencies n would be screwed well in, so that k well overlaps T .

The Stanley Earth-Resistance Indicator

This instrument, made by the General Electric Co. of London, shows at a glance, by the reading of the pointer on the scale, what is the insulation resistance of either main of a circuit on which it is connected. The construction of the instrument is the same as that of the Stanley ammeters and voltmeters, described on p. 46,

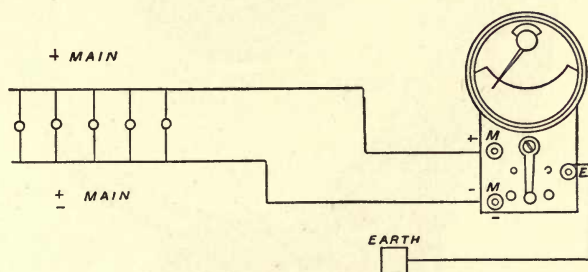

Fig. 218.—Diagram of Connections to Stanley Earth-Resistance Indicator

and the controlling force is either gravity, or that of a spring, whichever is desired.

The principle underlying the use of such an instrument is as follows:—Suppose a delicate ammeter or voltmeter to be connected between the copper core of one main and earth. There will be no current, or, at all events, an unmeasurably small one passing through it, due to the mains being electrically "alive", providing the other main is very well insulated from earth. If, however, this latter main is badly insulated, then a certain small current will flow, depending on the voltage of the circuit and the resistance offered by the instrument itself plus that of the insulating covering of the faulty main. This current and the deflection it produces will vary inversely as the resistance of the circuit just named. Thus when no current passes through the instrument, the pointer rests at the mark "Inf." on the scale, indicative of the resistance of the circuit in which it is placed being infinitely great. As the resistance of the insulation of the main becomes faulty and

less, the current increases, causing a deflection; and, if the faulty main had no insulation on it at all, the deflection would be a maximum, and the pointer would move to 0 on the scale. In this case the resistance of the instrument would alone be instru-

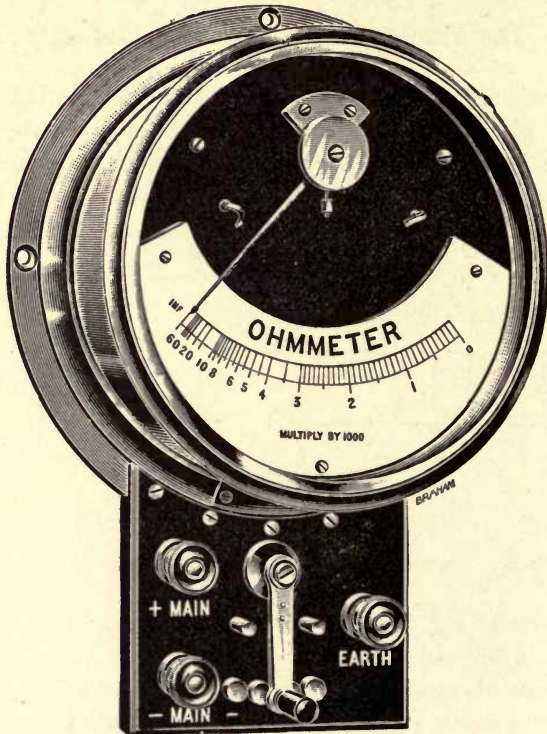

Fig. 219.—Stanley Earth-Resistance Indicator

mental in keeping the current through it, within safe limits. Hence such instruments are wound so as to have a considerable resistance, and are graduated to read directly in ohms at the voltage specified, and at which they were calibrated, and only on this will they read correctly.

The connections of the instrument to the circuit are indicated in fig. 218, and a general view of it is shown in fig. 219.

CHAPTER VIII

ELECTRICITY SUPPLY METERS

This portion of the subject of electrical engineering measuring instruments appeals both to the general public and to the electrical engineer, and is extremely important.

The instruments we have been considering in previous chapters are, of course, absolutely necessary items in the manipulation of electrical power for public supply purposes, but their cost compared with that of the rest of the plant is small, and therefore, financially speaking, they are not so important.

The case, however, is different with the electricity meter, one having to be supplied to each consumer.

Consequently the first cost of meters, the fact that they form the link between capital and revenue, and also that they decide what the consumer has to pay, makes the subject of them one of great importance, and more so than that of any other type of instrument.

There are really five conditions pertaining to the systems of distribution of electrical power at present in use, which give rise to as many different ways of measuring or charging for the energy supplied.

It may be convenient to note them in tabular form as follows:—

No.	Working Conditions of Circuit.		Quantity measured.	Name of Meter.
	Constants.	Variables.		
1	$A \cdot V \cdot t$	0	0	None.
2	$A \cdot V$	t	$\int_{t_1}^{t_2} dt$	Time check or hour counter.
3	A	$V \cdot t$	$\int_{t_1}^{t_2} V \cdot dt$	Volt hour meter.
4	V	$A \cdot t$	$\int_{t_1}^{t_2} A \cdot dt$	} Coulomb, or ampere hour meter.
5	0	$A \cdot V \cdot t$	$\int_{t_1}^{t_2} A \cdot V \cdot dt$	

Where A and V = instantaneous values of current and voltage, t_1 and t_2 being the initial and final times between which the energy is used, and therefore requires to be measured, and dt a very small interval of time.

An electricity meter, therefore, is an integrator of the variable quantities in a circuit.

Referring now to the above table, No. 1 is the case when no meter is used, the consumer being charged by contract under the distinct understanding that he only uses the lamps for the usual length of time each day.

No. 2 is used in conjunction with motors or arc lamps, &c., running on constant load, in which case the electrical power supplied to them is constant, only the remaining factor of the energy, time, being measured.

No. 3 is for series systems at constant current; while 4 and 5 are used with parallel systems of distribution, and are the two of most importance. We shall, therefore, consider these two types now in some detail, and subdivide the various forms as follows:—

Without clocks.	{	Chemical. Motor. Thermal.	With clocks.	{	Periodic integrator. Continuous integrator. Clocks affected.
-----------------	---	---------------------------------	--------------	---	--

The thermal form of meter has become obsolete, owing to the delicateness of its construction necessary to reduce frictions to a minimum. In fact, this form of meter requires friction to be reduced almost below the irreducible minimum if it could be, owing to their small driving torque.

Professor Forbes' thermal meter is a very neat and pretty instance of this kind of instrument, and a description of it will be found in Slings & Brooker's *Electrical Engineering*.

A great disadvantage in this type of meter is the large amount of energy wasted in it.

This question of the energy thus wasted is an important matter, as it may amount to a large item in a year.

The waste or loss of energy is in itself exceedingly objectionable; and it may also entail a fall of potential in the meter, which would reduce the available pressure for the lamps. Such fall should certainly not exceed 0.1 per cent of the working voltage, but in the best meters it does not exceed 0.075 per cent. Any reduction of pressure on the lamps at or about the normal voltage

entails at least six times that reduction in the luminosity. Thus the matter is not one that can be ignored.

The chief loss of energy, however, is not in the main-current circuit, which in the better meters does not exceed 0.5 watt, but in the fine-wire circuit in the case of energy meters, and in coulomb meters possessing shunt circuits for producing initial constant magnetization. This loss has been reduced to 1.5 watt in some forms, so that we may say that such instruments have a loss of at least 2 watts, though probably more often 3 or 4 watts, and sometimes 10 or 15.

Now since 1 year = (365 × 24) hours, and if 1 Board of Trade unit (1000 watt hours) costs 5*d.*, then the cost of energy wasted per annum, taking the power absorbed at 3 watts continuously, is

$$\frac{365 \times 24 \times 3 \times 5}{1000 \times 12} = 10.95 \text{ shillings, say } 11\text{s. per annum.}$$

At 5 per cent this represents a capital of about £11, which is a good deal more than the cost of the best meter, of the size which is used to the greatest extent at the present day.

A little consideration will show that the consumer pays for the wasted energy if the fine-wire circuit is across the mains on the lamp side of the main coils, and the supply company if it is connected on the opposite side.

Electrolytic meters, and those in which clocks are affected, commence registering with currents far less than is required for the smallest lamp made; and this is one of their great advantages.

Motor meters, however, give trouble in this respect, owing to the larger amount of friction to be overcome. This results in an uncertainty of action in starting, and may mean that two or three lamps can be used alone, and for nothing, without the meter starting.

In all cases meters should be capable of starting with the current taken by the smallest lamp used in practice, and should read accurately over their entire range, as a small error may amount to much in the year.

Meters possessing fine-wire circuits are liable to the temperature error met with in voltmeters; an error which can be minimized in the manner mentioned on p. 14. Copper being always used in the coils, this error within the usual limits of temperature may amount to 6 per cent or more.

A meter should require no attention beyond that of taking the dial readings once a quarter; consequently, it should not be too delicate or fragile, and should be capable of being sealed by the supply company in a dust- and water-tight case, to prevent it being tampered with by the consumer.

Moreover the internal parts should be *all* enclosed in a case of iron, so as to be shielded from external magnetic influence (p. 8).

In the case of motor meters the nature of the retarding resistances is twofold—one, that of *frictional resistance*, the *moment* of which, in present-day meters, varies from 50 to 1500 dyne centimetres, while the average value met with amounts to about 400 dyne centimetres.

This friction is practically the only serious trouble met with in this class of meter, and it both limits the accuracy, and causes wear and tear of the rubbing parts, in addition to loss of energy.

The other retarding resistance is that due to the brake, which may consist of either a rotating air-fan, which introduces a retarding moment \propto (speed)², or that due to Foucault current friction.

In the case of this latter, if the permanent field F causing the induced currents c is really constant, then

$$c \propto n \cdot F, \text{ i.e. } c \propto n,$$

where n = the speed.

But the retarding torque is \propto to this induced current c .

Hence the retardation is \propto to the speed n .

In well-designed motor meters the driving torque is \propto to the main current \times fixed-field in coulomb meters, and \propto to the main current \times pressure current in energy meters; and in present-day commercial meters it does not exceed usually 15,000 dyne centimetres.

A meter to be a commercial success at the present day must combine *simplicity* and *cheapness* with the greatest permanent *accuracy* and *freedom from failure*.

Of the six different types of meters mentioned on p. 202, the simplest, undoubtedly, is the *electrolytic*. Electrolytic meters are essentially coulomb meters, depending for their action on the well-known fact that the chemical decomposition is directly \propto to the current, *i.e.* to the number of coulombs passed. In other words they measure the $\int A dt$.

Hence on a circuit of *constant* pressure v , their readings can be made to denote $v \int A dt$, *i.e.* the energy supplied.

Their great advantage lies in the fact that they possess none of the errors accruing to motor meters in the matter of friction, &c.

The Bastian Electricity Meter

This meter, devised and patented by Mr. Bastian, and made by the Bastian Meter Co., London, is one of the most successful and accurate of electrolytic or chemical meters, and has been *approved* by the Board of Trade. It is, of course, only available for use with continuous currents, and will not work with alternating currents.

Since it belongs to the electrolytic class of meters, and depends for its action on the electrolysis of water, it is a coulomb (ampere hour) meter; but, at constant voltage, it will indicate on its scale the energy in Board of Trade units.

The principle of action depends on Faraday's well-known law in connection with liquid circuits, which states that the quantity of gas evolved, or volume of water decomposed, by a current of electricity, is directly proportional to the electrical energy at a given voltage, or to the quantity of electricity passing through it.

A general view of the interior of this meter, with the door of the containing-case open, is shown in fig. 220, from a reference to which the construction will be understood. This is extremely simple. It consists of a moulded glass tube terminating at the lower end in a spherical-shaped bulb or globe, while the upper end is open.

This outer receptacle is filled with the electrolyte, which is a very dilute solution of sulphuric acid and water, and a non-freezing mixture.

A hollow vulcanite box, into the top of which is fixed two vulcanite tubes extending upwards out of the top of the moulded glass tube, is contained in the glass bulb or globe. This box supports the platinum electrodes and the lead leading-in wires which pass through the vulcanite tubes. The ends of these wires are clamped to the terminal blocks seen at the top on the inside of the containing-case or box.

This case is made either of wood, cast-iron, or tinned and

japanned iron plate, a window being inserted in a hinged door, through which the fixed scale of the meter can be read without having to open the door.

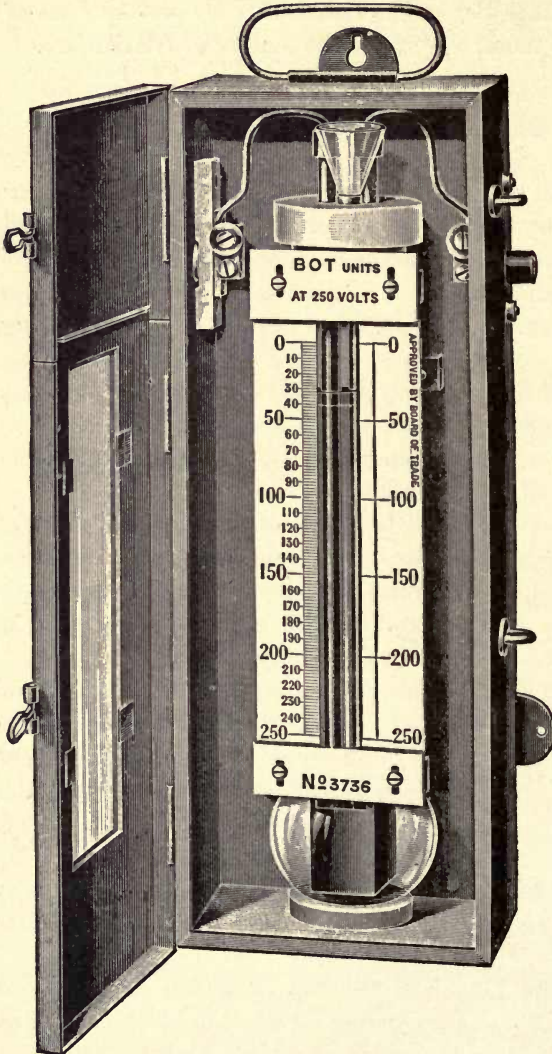

Fig. 220.—Bastian Electrolytic Meter (interior)

The graduated scale representing B.O.T. units at some definite pressure, and having its zero at the upper end, is fixed to the vertical moulded glass tube containing the electrolyte, directly in front of it, the level of the solution being read off on the scale.

A little paraffin-oil is poured on to the surface of the electrolyte to prevent atmospheric evaporation, the reading at any time being taken from the straight line formed by the junction of the oil and electrolyte, and not from the upper surface of the oil.

In fig. 220 the meter reading is just 40 B.O.T. units. The whole of the current to be metered passes

from one platinum electrode to the other, through the electrolyte, which decomposes the water in it alone, the oxygen and hydrogen gases evolved escaping up the vulcanite tubes into the air. The level of the electrolyte is thereby gradually reduced at a rate

strictly proportional to the quantity of current passing from time to time.

Thus the difference in the height of the liquid between two readings, as indicated on the scale, is an accurate measure of the quantity of current, or of the energy at constant voltage, that has been consumed in the circuit.

The meters require to be refilled periodically with fresh water. This can easily be done without removing any of the parts from

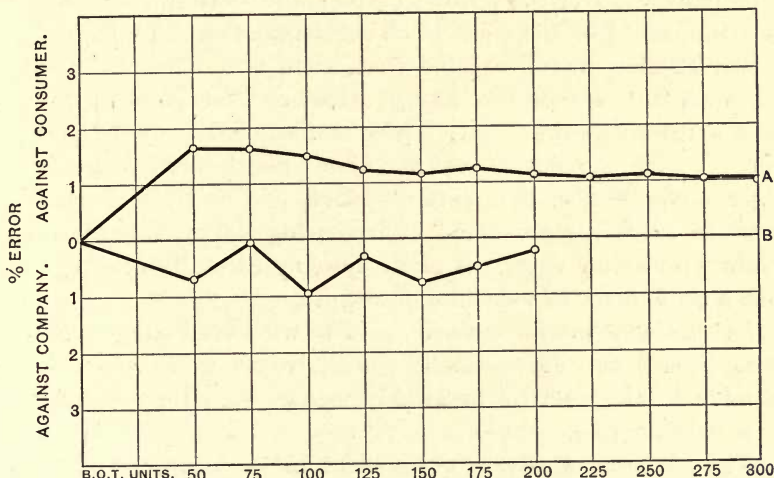

Fig. 221.—Error Curves of Bastian Electrolytic Meter

the case, by means of the conical funnel which leads into the moulded glass tube through the cover at the top.

Refilling is not likely to be required more than about once a year, however; while meters for three-wire circuits require refilling after about 1000 B.O.T. units have been used. In connection with this system of distribution, the consumption on each side of the three-wire net-work is registered independently by two separate meters, which are fitted in one case.

This kind of meter is highly suitable for use in hot and dusty positions; and it can be used on motor circuits owing to the heavy starting currents being accurately measured, while the calibration of the meter is unaffected by such overloads.

The Bastian meter will accurately measure the smallest possible current that can be passing in the circuit, if only a leak on the house-wires; and the accuracy of the calibration throughout the full

range of the meter—even with heavy excess loads—is guaranteed to be within 1 per cent of error over the full length of the scale. Fig. 221 shows the error curves of one of these meters.

Polarization and back E.M.F. can produce no such errors as are possible, indeed unavoidable, in the case of all shunted electrolytic meters, whether copper-depositing, mercury-depositing, or of any other type, as there is no shunt in the Bastian meter.

Provided a fuse is in circuit, arranged to “blow” at 100 per cent, or thereabouts, over the normal current, the Bastian meter will be quite unharmed by the effect of an accidental short circuit.

Mr. Bastian has discovered that when two uninsulated wires dip down into a liquid, a heavy excess current passing through those wires causes the negative wire to fuse exactly at the point of junction with the liquid—neither above nor below. And in the meter under notice, this curious effect, which we will term the “Bastian effect”, is prevented by insulating the platinum wires, at points where they enter the electrolyte, by carefully coating them with a thick layer of vulcanite or ebonite.

In this way the meters are made to withstand the effects of a short circuit, as above stated; whilst, before this discovery, the negative leading-in wire invariably melted, even though protected by a delicate fuse.

The meter is, of course, quite silent in working; and the gases given off are of an entirely inoffensive nature.

A 5-ampere meter working under full load for two hours evolves something less than one-fourth of a cubic foot of oxygen and hydrogen—quite a harmless quantity.

The electrolyte “ages” after a certain quantity of electricity has passed, and its conductivity improves. This improvement is maintained after the meter has been refilled, and the resistance of the electrolyte consequently tends to decrease with time.

This decrease of resistance, however, does not affect the accuracy of the meter in any way, as there is no shunt; and for the same reason the accuracy is unaffected by variation in the specific gravity of the electrolyte.

Unlike many other forms of meters, particularly those of the motor class, this electrolytic meter cannot register too fast, or too slow, or reverse; and an almost infinitesimal amount of energy is consumed in it.

The meter being in every sense of the word a quantity or

coulomb meter, its construction is entirely unaffected by the voltage of any circuit for which it may be intended. Only the calibration is concerned with the voltage, since the thing actually measured is $\int A dt$. At any constant pressure v , the scale can be marked off in B.O.T. units to correspond. It is now made for any current up to about 25 amperes at any voltage.

Edison's Electrolytic Electricity Meter

This meter, until recently made by the Edison & Swan United Electric Light Co., is a "quantity" or "coulomb" meter applicable to continuous-current supply systems. It is really a specially-arranged form of voltameter; and in common with all such appliances depends for its action upon the principle, that the amount of chemical decomposition taking place in a voltameter due to the passage of a current, is directly proportional to the product of the current strength and the time for which this current flows. Consequently, this meter measures the quantity of electricity that is given to any particular circuit in which it is placed, in ampere hours. It has been largely used in America, and has the advantages of being cheap in first cost, simple in construction, and accurate when due care is taken. One inherent disadvantage, however, is the somewhat frequent periodical visits to the meter for the purpose of taking the gain plates out and weighing them in order to obtain the weight of the deposit. The change in weight of the plates, during any period, is directly proportional to the quantity of electricity supplied through the meter.

Fig. 222 shows the arrangement of the interior of the meter when intended for two-wire systems of supply. It consists of two corrugated low-resistance strips of platinoid, or manganin (seen at the top of the containing-case), placed one in series with each main.

Connected to the ends of each strip are two voltameters A, A , each consisting of a glass jar containing a saturated solution of zinc sulphate and water. Into this solution dip two zinc plates, fastened together with a hard rubber bolt and nut, but insulated from each other by a short air-gap.

The connecting wires, leading the current in at one plate and out at the other, pass through a rubber cork which seals the jar. The voltameters are in parallel with each other across their respective strips, and since the amount of electrolytic action is the

same in all parts of a circuit at the same instant, the sum of the deposits of zinc on the cathodes of each pair of voltameters will be the same, and therefore one pair will form a check on the other.

From the foregoing considerations, it will be seen that the electrical design of the meter is such that only a small percentage of the total current entering it passes through the voltameters, causing the deposit on their cathodes.

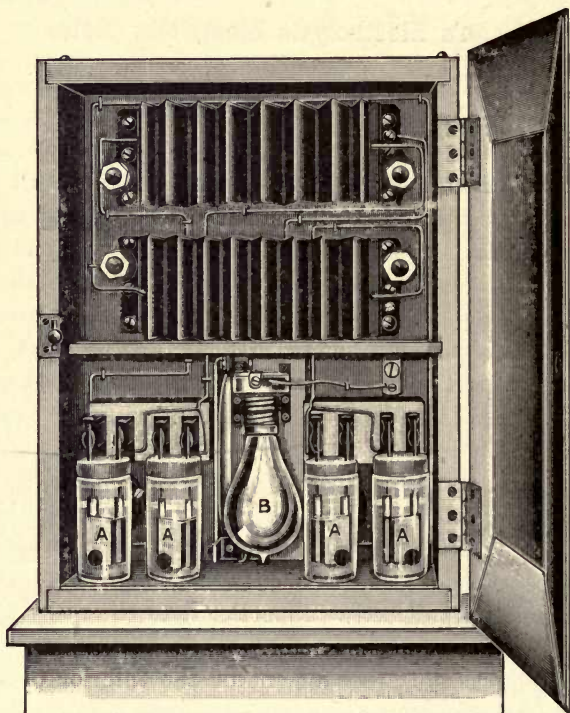

Fig. 222.—Edison Electrolytic Electricity Meter (interior)

The above arrangement, however, would be very well if the resistance of shunt and strip varied in direct proportion with changes of temperature; but the resistance of liquids *decreases* with rise of temperature, whereas that of metals *increases*, so that grave errors would arise in the meter readings if allowance was not made for this fact. This is done, in a very simple way, by placing directly in series with *each* voltameter a small copper compensating resistance, of such a value that the increase in its resistance just balances the decrease of that of the voltameter for the same temperature.

In this way the resistance of the shunt is kept constant for

variations of temperature, and since that of the strip varies very slightly with temperature, errors due to this cause are practically eliminated.

This compound shunt is often made $\frac{1}{99}$ th of the resistance of the strip, so that the deposit which occurs in the voltmeters is that due to $\frac{1}{100}$ th of the total current passing through the strip or meter.

A provision is also made in this meter for preventing the solution freezing in cold weather, which may be termed a *thermostat*, and is shown at B, fig. 222, midway between the two pairs of voltmeter jars.

It consists of a glow-lamp, one terminal of which is connected to one main, while the other is joined to a fixed stud, seen at the top left-hand cap of the lamp.

A movable stud is carried at the free end of a vertical compound lever. This lever consists of two strips of different metals soldered together, and of which the one that expands and contracts most with temperature is placed inside.

The other main is connected to the fixed end of this bar or lever. Thus when the temperature gets too low the bar bends, due to unequal contraction of its parts causing the moving stud at its upper or free end to touch the fixed stud and so light up the lamp.

The warmth from B is sufficient to prevent A A from freezing. Rise of temperature causes the bar to curl in the opposite direction, thus breaking circuit.

The point or temperature at which the thermostat B is brought into action can be regulated by means of a set-screw and nut.

This type of meter is made for currents up to 600 amperes, and a specially-arranged one is employed for use on three-wire systems.

The Long-Schattner Prepayment Electricity Meter

This belongs to the electrolytic class of meter, and is consequently a coulomb meter. On constant potential circuits, however, its scale can be graduated in Board of Trade units in the manner indicated on p. 205. The meter has been approved by the Board of Trade; and its action depends on the electrolysis of copper sulphate with copper electrodes. These latter, together with this particular electrolyte, have been chosen because the electrolysis of this solution is better known in all its conditions than that of any other salt,

owing to the enormous scale on which it is carried out at the present day. The chemical work done at one electrode is undone at the other, and except for the transfer of a certain amount of copper from one to the other, all conditions remain unchanged. Thus it is possible to reduce the drop of voltage to a very low ebb, while at the same time the resistance, strength of solution, and all other conditions remain constant. Many of the objections to electrolytic meters are overcome in the Long-Schattner—for instance, the deposition of the metal is downwards upon a cathode, relatively large compared with the anode. The current density

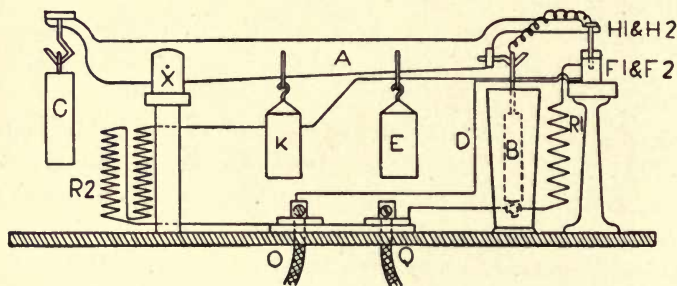

Fig. 223.—Long-Schattner Electrolytic Prepayment Meter (General principle)

therefore at the surface of the plate is small, and a regular deposit is the result, adhering firmly to the cathode.

This Long-Schattner instrument is extremely simple in principle, and is designed to allow of the introduction of the prepayment system, practically without additional mechanism. The meter, however, is only applicable to direct currents, and will not work with alternating currents.

The construction of the Long-Schattner prepayment meter will be best appreciated from the accompanying diagram of the instrument and connections (fig. 223).

In this diagram, A is a lever pivoted at X. At one end of the lever is suspended a copper plate B, which is immersed in a solution of copper sulphate contained in the box D, which is also of copper, and forms the negative plate, or cathode. C is a weight to balance the other side of the lever. K and E are cups to hold respectively the coins that come in through the slot, and the standard weights with which the collector replaces the coins when he collects them, thus leaving the balance, or rather want of balance, unchanged. F₁ and F₂ are mercury cups; F₁, the large one, is filled with

mercury; F_2 , the small one, is half-filled with mercury and then filled up with creosote oil. H_1 and H_2 are contact pieces forming a bridge across the mercury cups, which bridge is fixed on the lever. R_1 is a main resistance, across which the depositing cell BD is connected as a shunt, and R_2 is a large resistance connected across the mercury cups.

The connections are shown more fully in fig. 224.

From this it will be seen, that when the lever is "up" the mercury connection in the cup F_2 is broken, and the current has to

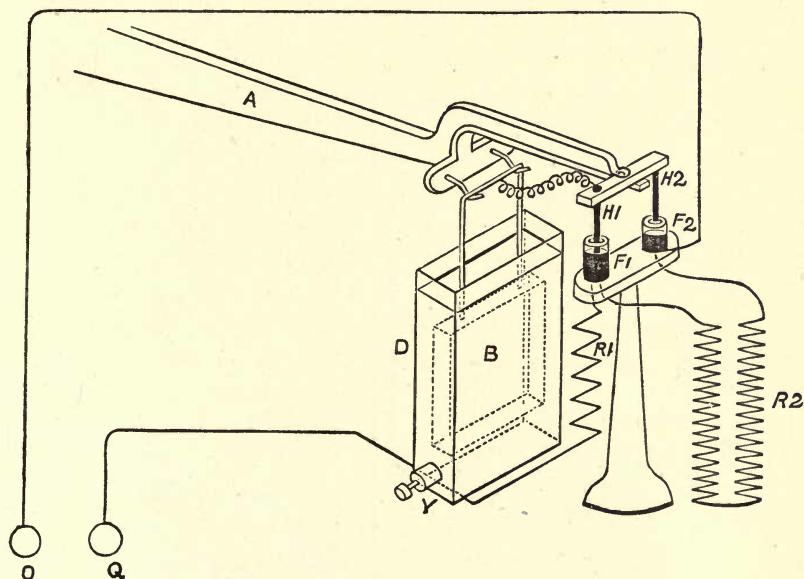

Fig. 224.—Long-Schattner Electrolytic Prepayment Meter (Electrical connections)

pass through the resistance R_2 . The course of the current is then as follows:—

I. (When the lever is "down".) Entering at O to mercury cup and contact piece F_2 , H_2 ; from there part goes through a connection to plate B , across to the box D , depositing copper from B to D and out to Y ; the other part, the main current, goes from H_2 to H_1 , and F_1 , through the resistance R_1 , and joins the other part at Y , both leaving at the terminal Q .

II. (When the lever is "up".) The contact piece H_2 is out of the mercury, and the current has to take a course through the resistance R_2 , which causes a very large drop in voltage; a part again goes

through R_1 , and the other part up H_1 to the plates B and D, and joins the other part at Y as before.

Resistance Cut-out.—Fig. 225 is necessary to explain the device denoted by R_2 in the above two figures.

It will be seen that a single resistance across the mercury cups would not answer entirely satisfactorily, as with only one or two lamps the dimness produced would not be sufficient. Or again, if it were made sufficient, the lamps would be practically extinguished

if the full or nearly full complement of lamps happened to be on when the meter ran out its money.

Another point that has been suggested is, that with such an arrangement, an unprincipled customer with sufficient knowledge might insert lamps of a low voltage, and thus continue using the current without inserting any coins. Of course, practically, that would not be possible; as the inspector, when he came round, would at once notice that the meter had been put "out of balance"; but the arrangement in fig. 225 obviates both these difficulties.

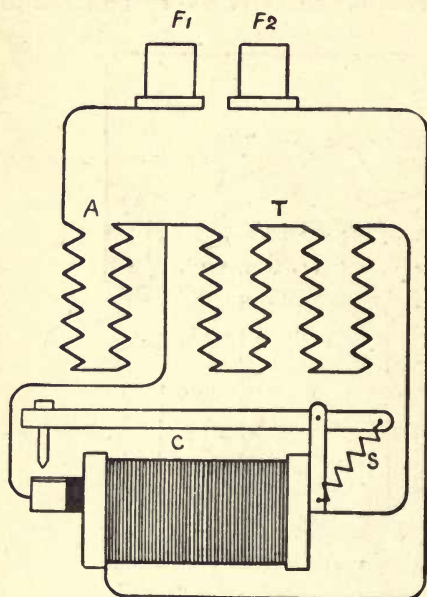

Fig. 225.—Long-Schattner Electrolytic Prepayment Meter (Resistance Cut-out)

A is a medium resistance, and T a high resistance; in series with these is the relay C. These three resistances are connected in series across the mercury cups F_1 and F_2 , and S is a spring acting against the armature of the relay. When the armature of the relay pulls up, the high resistance T is cut out.

The action is as follows:—

When the circuit is "broken" by the lever with only two or three lamps on, the high resistance is kept in series, thus causing proper dimness of the lamps. With many lamps on when the "break" occurs, the relay pulls up, cutting the high resistance T out of circuit. Thus a proper dimness is always obtained.

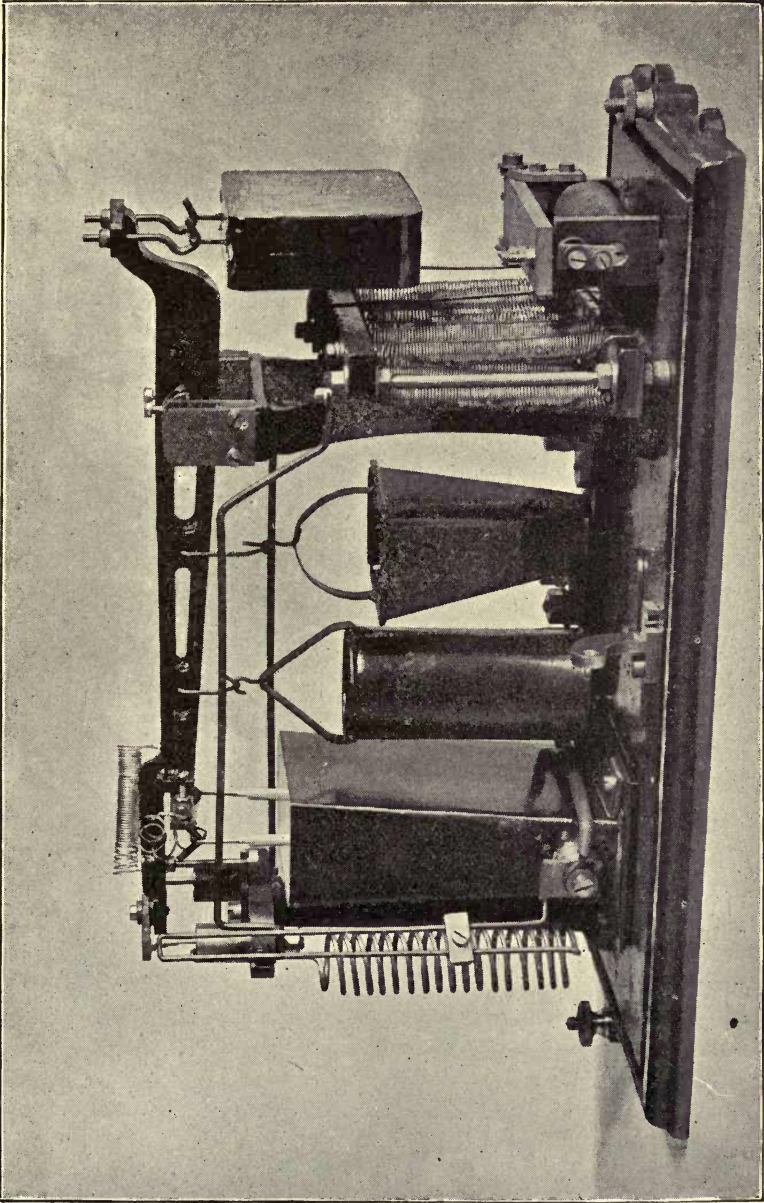

Fig. 226. — Long-Schattner Electrolytic Prepayment Meter (interior, with Cover off)

From the above explanation the complete action of the meter will be understood. The lever is "up", say, to start with. A coin

has to be inserted, which brings the lever down, establishing a short circuit across the mercury cups. It keeps in this position until the amount of electricity equivalent to the coin has been used, that is, until B is lightened enough to cause an overbalance, breaking H_2 and F_2 , and causing the current to pass through the dimming device. Thus the circuit is never actually broken, but the lamps turned on continue to burn so dimly as to force the consumer to insert another coin to get any appreciable light, whilst he has also to pay for the light he burns dimly, as that too goes, as before, through the voltameter. In reality the next coin he inserts pays for that light. By never completely cutting off the light a great advantage is gained. It is distinctly a disadvantage in a prepayment meter that the consumer should suddenly be put in darkness. It has been found that the creosote in mercury cup F_2 is very effective. It causes a perfectly sparkless "break" and "make", even at full load on a 220 volts circuit, and it also keeps the contact maker, H_2 , perfectly clean. It does not deteriorate, neither does the mercury, so that the cups need no further attention when working.

One copper plate and box, *i.e.* the depositing cell, will last about 600 units, and then has to be replaced with a fresh plate and box, at a cost of four shillings. The box and plate are made easily detachable from the meter.

It is necessary to pour a thin layer of ordinary machine-oil over the top of the copper solution, thus preventing any evaporation, and *rendering creeping impossible*. This does not affect the plate or box at all, the only precaution necessary is to rinse the box and plate with water when removing the solution. The copper solution, thus preserved, is not affected by time, temperature, &c., and keeps in good condition for three or four years.

The meters are calibrated to any required rate per B.T.U.

The copper sulphate solution is of 1.080 specific gravity, and is made up of 1 per cent sulphuric acid and 99 per cent water.

Fig. 226 shows an internal view of the Long-Schattner prepayment meter with cover removed, while the outside appearance of the meter is depicted in fig. 227 with its cover on.

Silver coins as well as pennies can be used—*viz.* threepence, sixpence, and a shilling.

With each meter are supplied standard weights to cover the life of a plate; these weights are placed in the standard-weights

pan by the collector as he extracts the money. This is a detail that must be mentioned here, because these standard weights are

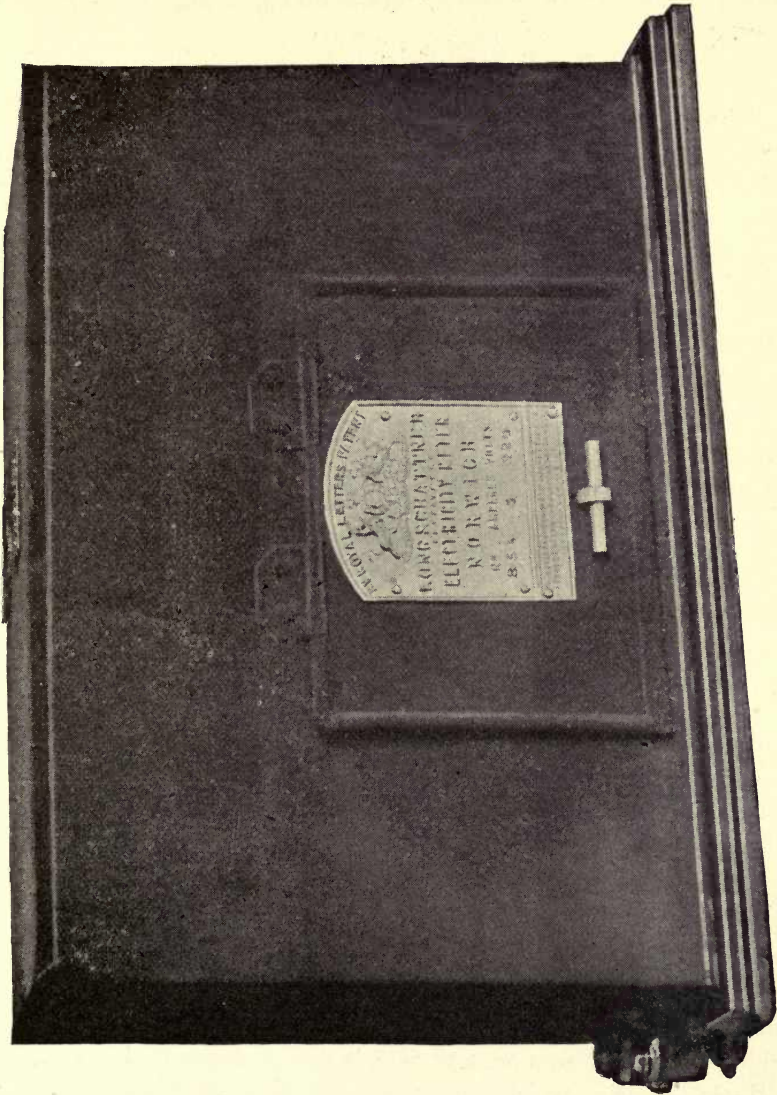

Fig. 227. — Long-Shattner Electrolytic Prepayment Meter (Cover in position)

an important feature of the meter from a consumer's point of view. A silver coin, though passing at its full value, has frequently lost a fraction of its weight by wear, but the consumer does not lose by this. For instance, suppose all the coins inserted during a month

or longer have been light or worn coins, when the collector calls he exchanges these for the standard weights. The consumer can then take the full amount of energy due to him just as if had used new coins.

The Schattner Standard Meter

The Schattner meter was originally brought out in the above form, namely, as a prepayment meter, its design being such as to offer special facilities in that respect. The instrument was, how-

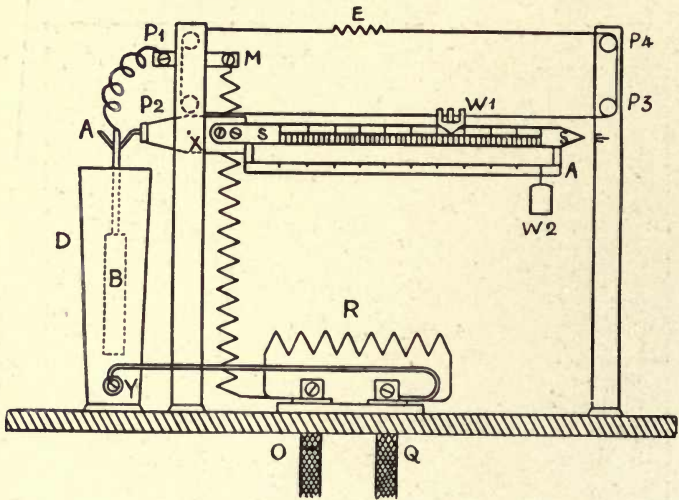

Fig. 228.—Schattner Standard Meter (principle)

ever, subsequently modified so as to form an integrating meter of the ordinary recording type.

The recording meter works on the same principle as the Long-Schattner prepayment meter, which it very closely resembles, so that only a very short description will be necessary.

Fig. 228 shows the arrangement diagrammatically. AA is a lever pivoted at x, from one side of which the copper plate B is suspended in a copper sulphate solution contained in the box D, which is also of copper, and which forms the negative plate or cathode. R is a resistance across which the voltameter is connected as a shunt. The current enters at o, and the main part goes through the resistance R to q, where it leaves the meter; but a part goes from o to M, then through a flexible connection to the plate B, through the depositing cell, carrying over copper from

B to D, and then from the terminal Y back to Q. On the other side of the lever are two scales SS, one over the other, which carry weights w_1 and w_2 . The upper scale has one hundred divisions, and the weight w_1 is so adjusted that each division represents one unit. The lower scale, which is the same length as the other, has ten divisions only, and each represents 100 units. w_2 is a weight suspended on the notches of the lowest scale, and is exactly ten

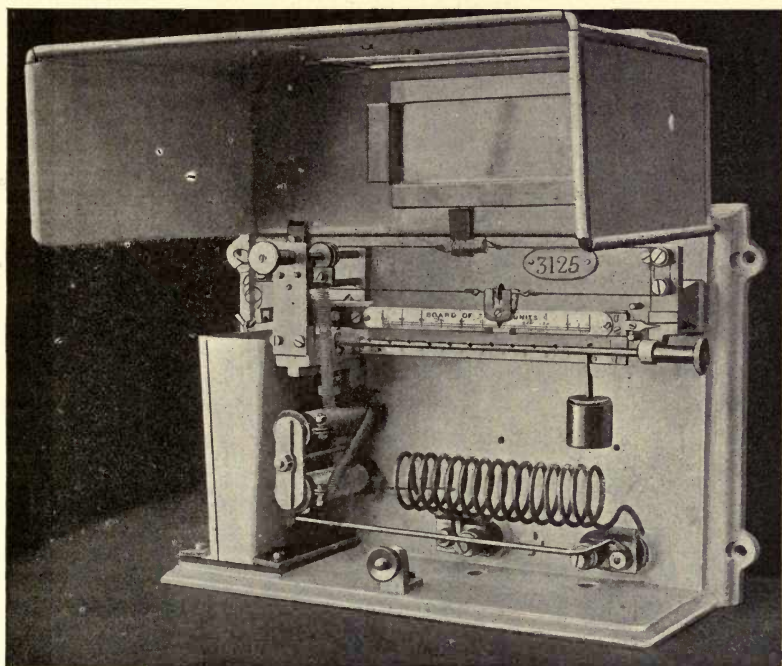

Fig. 229.—Schattner Standard Meter (interior, with Cover open)

times as heavy as w_1 . Moving w_2 one notch farther is equivalent to 100 units, or moving w_1 all along the top scale.

TO READ THE METER.—As the current passes through the meter the plate B gets proportionately lighter, and the units used are read off from the scales after the position of the weights has been adjusted, so that balance is obtained. w_1 is in the form of a slider, which is moved along the scale by means of a cord which passes round the pulleys P_1, P_2, P_3, P_4 ; P_1 having a long spindle which passes through the case, and carries a milled nut on the outside. The cord is not attached to the slider itself, as this would cause an

error, but to a button which plays between two stops on the slider. E is a small spring to keep the cord taut. The arrangement for moving w_2 is not shown in the figure, but this is also actuated from outside the case. The length of the scale is 5 inches, a unit is therefore represented by $\frac{1}{20}$ inch, which is amply sufficient for accurate reading.

The Schattner standard electricity meter has been tested most thoroughly, and has given very satisfactory results, the chief advantage being its great accuracy at all loads. Owing to this,

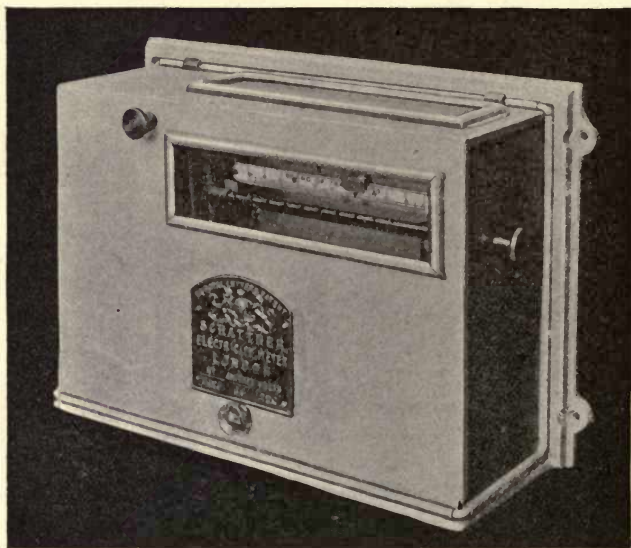

Fig. 230.—Schattner Standard Meter (Cover in position)

the meter may be tested and calibrated at any convenient load, and will, if correct then, be correct also at any other load within its range. It registers correctly down to 0.15 ampere, which is less than the current taken by the smallest lamp.

One copper plate and box will last from 1000 to 1100 units for meters up to 10 amperes capacity, and 2200 units for meters of 25 amperes capacity, it then has to be replaced by a fresh plate and box, at a cost of about four shillings. The plate and box are made easily detachable from the meter for this purpose. When the case is fixed, no tampering is possible.

It is necessary to pour a thin layer of ordinary machine-oil over the top of the copper sulphate solution to prevent evaporation.

This has no effect on the plate or box, the only precaution necessary being to rinse the box and plate with water when removing the solution. The copper solution thus preserved is unaffected by time and temperature, and will keep in good condition for three or four years. The strength of the copper solution is that given on p. 216 for the prepayment meter.

Fig. 229 shows the internal view of the Schattner standard electricity meter with cover open, most of the parts being visible.

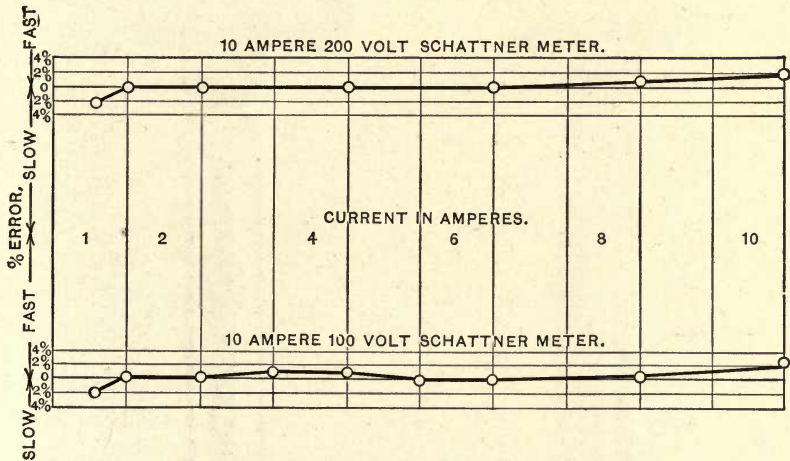

Fig. 231.—Schattner Standard Meter (Error Curves)

The general outside appearance of this meter with cover on (in position) is represented in fig. 230.

The curves relating percentage error and load in the case of a standard Schattner meter for 10 amperes in each case, but 100 and 200 volts respectively, are depicted in fig. 231. These apparently show that there is no appreciable difference in the two sizes, and in neither of them does the percentage error exceed about 2 per cent. This only occurs just at the beginning and at the end of the range.

Wright's Electrolytic Meter

This meter, which is made by the Reason Manufacturing Company of Brighton, is of the shunted electrolytic type. Its principle is the same as that used in electro-plating, *i.e.* the amount of metal deposited is proportional to the quantity of electricity passed through the electrolyte. The latter consists of mercurous nitrate,

the anode A, fig. 232 being metallic mercury, and the cathode C, platinum. All these parts are contained in an *hermetically sealed glass tube* T. In series with the electrolytic cell is placed a high resistance, both being connected in shunt to a low resistance,

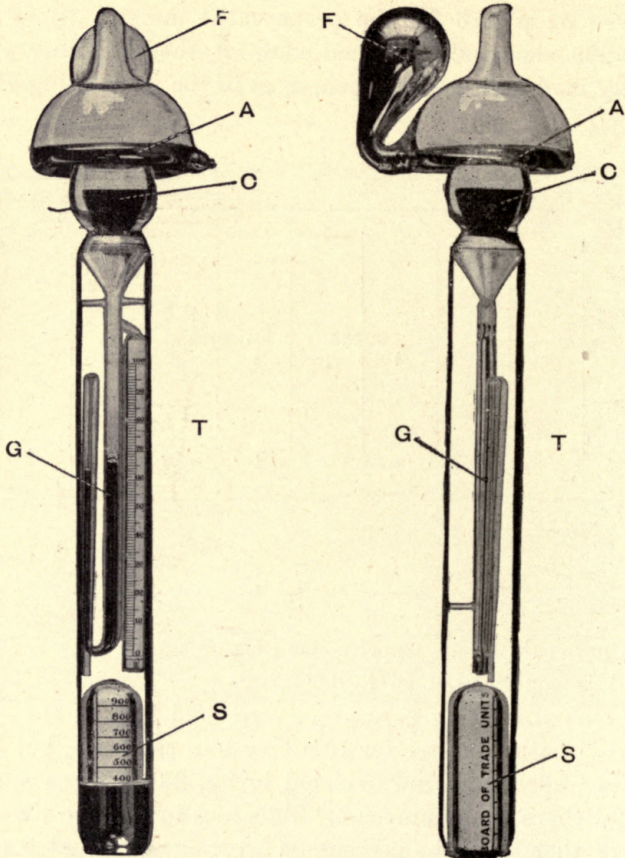

Fig. 232. — Electrolytic Cell of Wright Meter (front and side views)

so that only about $\frac{1}{200}$ of the current to be measured passes through the cell.

The electrical connections are shown in the accompanying diagram, fig. 233.

The current enters at the terminal D, and the greater part of it passes round the low resistance R to the terminal E. The shunt current, which works the meter, and which is always an

exact fraction of the total current, passes from D through the fine-wire resistance P to the mercury anode A. Thence it goes through the electrolyte to the cathode C, and finally to the terminal E. The relations of P and R are calculated in the first instance, but the exact final adjustment is made by sliding the two wires L and M up or down in two holes drilled in E and D, and so varying the value of R. A motion of about $\frac{1}{4}$ inch of L and M in E and D effects an adjustment of about 1 per cent.

When a current is passing through the meter, metallic mercury is deposited on the cathode, whence it falls in minute globules into the first graduated tube G, which reads direct in units. This is made in the form of a siphon, so that when it is filled by a quantity of mercury equal to 100 units it automatically and completely empties itself into the lower tube. This is provided with a scale S, of which each division is equal to 100 units. In the standard form of this meter there are ten of these divisions, bringing the total capacity of the meter up to 1000 units. The mercury as it is dissolved from the anode is simultaneously replaced by fresh metal drawn from the anode feeder F. The latter acts in the same manner as the well-known "bird-fountain" in keeping the level of the mercury constant.

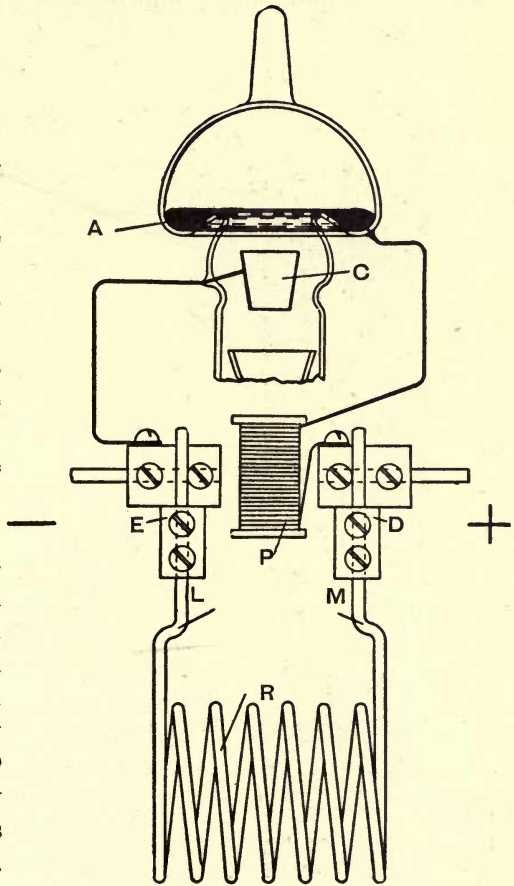

Fig. 233.—Electrical Connections of Wright Meter

After 1000 units have been registered the meter has to be reset to zero. This is done by the simple operation of tilting the whole tube about the hinged supporting brackets, so that all the mercury is returned to the anode and feeder. The reading tubes are left quite empty and the meter is in precisely the same

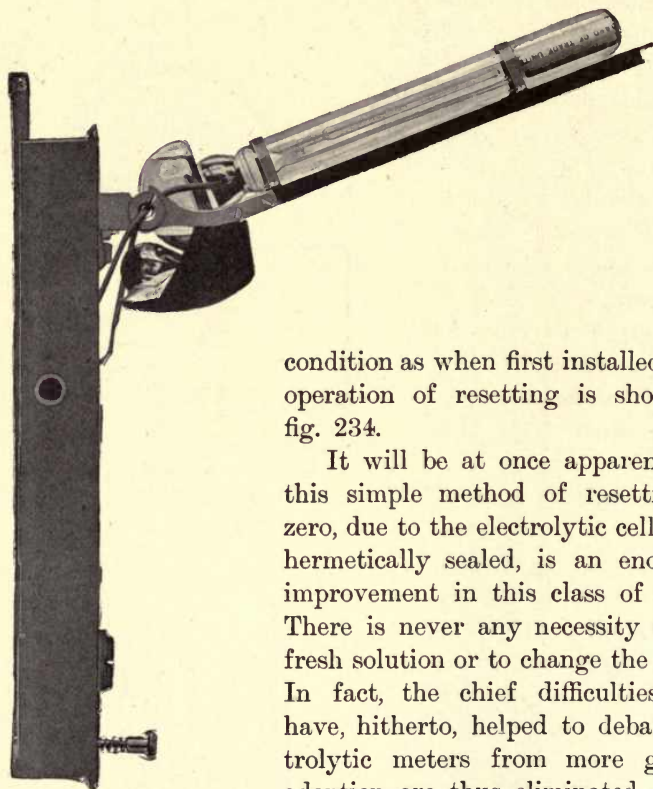

Fig. 234.—Operation showing Method of Resetting Wright Meter

condition as when first installed. The operation of resetting is shown in fig. 234.

It will be at once apparent that this simple method of resetting to zero, due to the electrolytic cell being hermetically sealed, is an enormous improvement in this class of meter. There is never any necessity to add fresh solution or to change the anode. In fact, the chief difficulties that have, hitherto, helped to debar electrolytic meters from more general adoption are thus eliminated.

In calibrating the meter, the point at which the mercury siphons over is first determined by experiment, and the distance between the zero and this point is made equal to 100 units.

The siphon tube is then divided very carefully between those two cardinal points, so that the amount of mercury contained in each of the 100 divisions is exactly equal to one unit. A further test is made after fixing the siphon in the main tube to verify that the siphoning always occurs exactly at 100 units' reading. The tube, resistances, and other parts having been fitted into the

case, the meter is then tested for a lengthy period on varying load.

This meter has the great advantage that the back E.M.F. in the electrolytic cell is reduced to a negligible amount, and does not exceed $\frac{1}{10000}$ volt. As the drop in the meter is 1 volt at full load, the disturbing effect of the back E.M.F. at $\frac{1}{100}$ load is not more than 1 per cent.

The drop of pressure in the meter does not exceed 1 volt, which is smaller than that met with in some forms belonging to this class of meter.

It may be asked how the small but perceptible back E.M.F., which is found in electro-plating, and which is manifested in shunted electrolytic meters where metals are deposited, is got rid of. The answer is, that such a counter E.M.F. is caused only by differences of concentration in

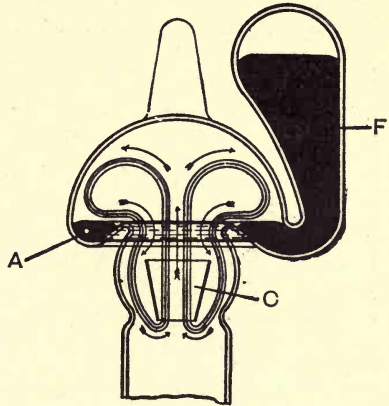

Fig. 235.—Principle of Automatic Stirring of Solution by Action of Gravity

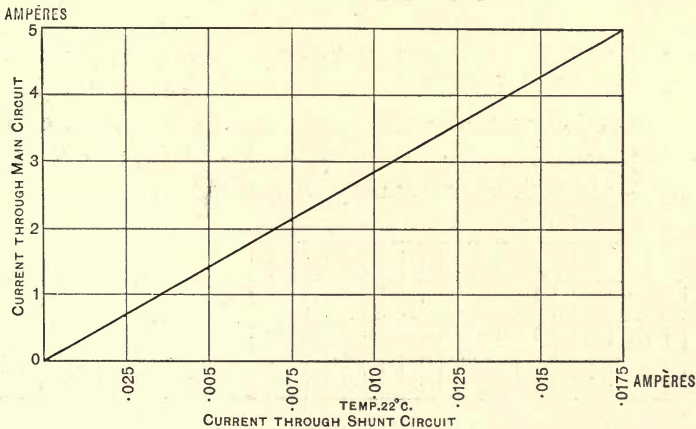

Fig. 236.—Curve Showing Constancy of the Total Resistance of Cell Circuit

different parts of the electrolyte, and that, by suitably stirring the solution, it can be made extremely small. In this meter the circulation or stirring is done by gravity, and is entirely automatic.

The heavy solution formed at the anode falls, while the weaker solution at the cathode rises, the interchange of solution being assisted by the curved surface of the mercury anode. The process is illustrated in fig. 235, which exhibits the stream lines in the solution.

The fact of having the anode above the cathode is thus seen to be of vital importance. So desirable was it to encourage this gravitational circulation that in some of the earliest meters of this form the mistake was made of having the anode trough too shallow, and thus running the risk of some of the mercury spilling over when the meter was subjected to vibration. It was found, however, that the auto-

matic circulation was so active that the anode trough could be made deep enough to prevent any possible spilling over of the mercury, even with extraordinary vibration.

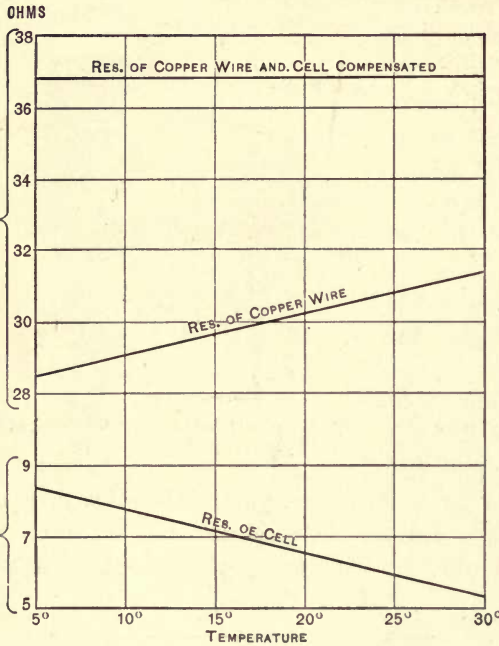

Fig. 237.—Curves showing Method of Compensation for Variation of Temperature

matic circulation was so active that the anode trough could be made deep enough to prevent any possible spilling over of the mercury, even with extraordinary vibration.

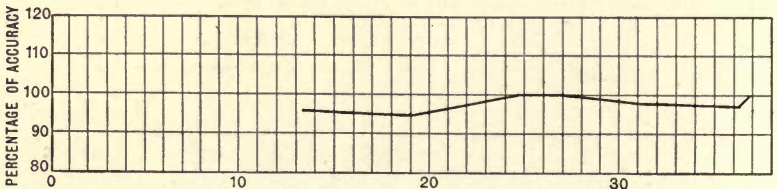

Fig. 238.—Error Curve at Very Light Loads

The efficacy of this circulation may be judged by the fact that, for an hour, the meter can be overloaded to three times its normal capacity, before the solution at the anode becomes heavy enough to deposit crystals, the production of which is, of course,

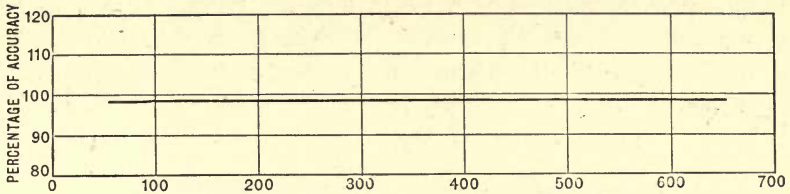

Fig. 239.—Error Curve at Ordinary Working Loads

the sign of the concentration of the solution to the point of saturation.

Constancy in the resistance of the cell follows naturally from the arrangement of the parts. As previously explained, the anode feeder keeps the surface of the anode always at exactly the same level in the circular trough. Its average distance from the cathode is therefore unvarying. The area of its surface is also constant, as this depends only on the height to which it rises in the trough. The areas of anode and cathode, and the mean length of the conducting path for the electricity, thus being all constant, the resistance cannot alter. The total resistance of the cell circuit, consisting of the electrolyte and the fine-wire coil, which is large in comparison, must therefore remain constant. That this is so, and that consequently the shunt resistance and current are always exactly proportional to the main resistance and current, is exhibited in fig. 236, where the straight line graphically represents the observed values. It follows, from these conditions, that a shunted meter such as described will always register accurately.

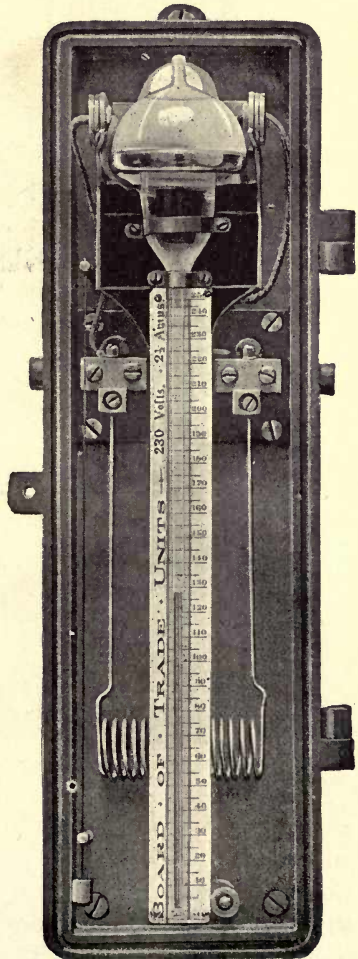

Fig. 240.—Standard Type of Wright Meter (up to 5 amperes)

The proper compensation of meters for temperature changes is, as a rule, not insisted on so strongly as it should be.

In those furnished with metallic brakes, it is difficult to effect the compensation, but, in the present case, an easy remedy lies at hand. The resistance of the electrolyte diminishes with in-

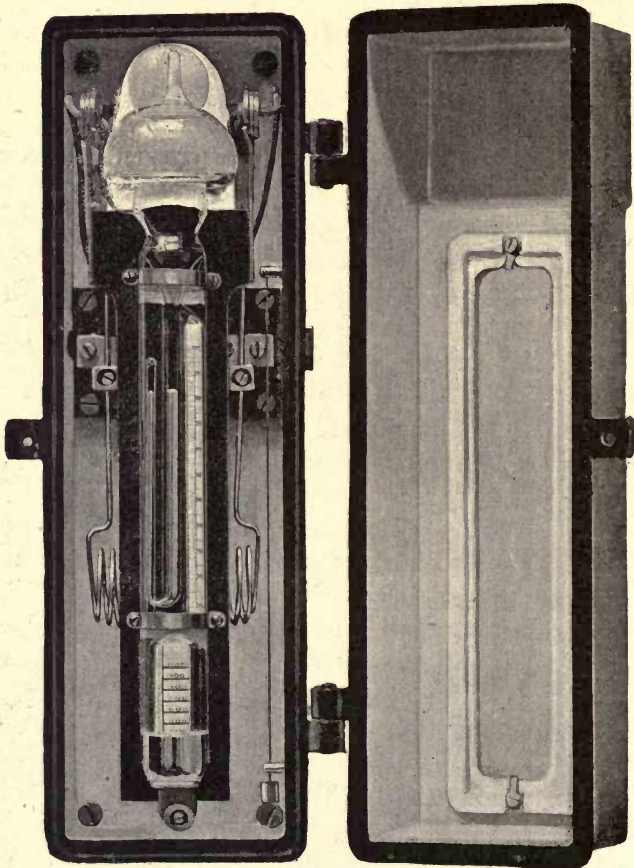

Fig. 241.—Standard Type of Wright Meter with Door Open (currents up to 10 amperes)

crease of temperature, while the reverse takes place with copper wire. If, therefore, the fine-wire bobbin be wound with a sufficient proportion of copper, within given limits of temperature the rise in its resistance will counterbalance the diminution in that of the electrolyte. The resistance of each cell having been carefully measured for this purpose, the requisite amount of copper

wire is first wound on the bobbin, and the remainder of the total calculated resistance in the cell circuit is made up of platinoid. There is enough fine-wire resistance in the case of a 10-ampere meter to compensate it perfectly between the limits of 5° and 25° C. This very complete compensation for temperature renders the meter eminently suitable for tropical climates, or for countries where the range of temperature is large. The curves in fig. 237 show graphically the relative values of the resistances to compensate a particular meter.

It is customary and necessary with most meters to differentiate between the accuracy at $\frac{1}{10}$ th and full load. In the present case, the curve of registration being a perfect straight line, the accuracy is the same at all loads. To demonstrate the fact, tests have been made which lasted over a period of many months, with currents which are smaller than any used in electric lighting, *i.e.* with 0.1 and 0.05 ampere. That the meter successfully vindicates the efficacy of the means employed to render it accurate, even at these extraordinarily low loads, is shown by the curve, fig. 238. Fig. 239 is the characteristic curve for ordinary working loads. The regular practice in the calibration of these meters is to pass only such meters as do not show a greater error than 1 per cent at any load.

Fig. 240 shows the standard form of the meter made for 2½- or 5-ampere installations. It is furnished merely with a plain graduated tube which reads up to 250 units. After this quantity has been recorded the meter must be reset.

In the 10-ampere standard design, by means of the "second dial" effect of the siphon tube, a registration of 1000 units can be obtained before resetting is necessary. Meters, when they are of

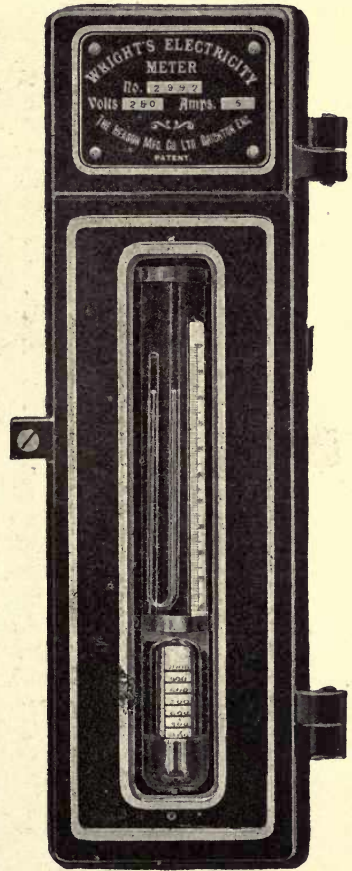

Fig. 242.—Standard Type of Wright Meter with Door shut

the motor type, are usually classified into $2\frac{1}{2}$ -, 5-, and 10-ampere sizes, as the starting current and the accuracy at low loads are different for different sizes. But obviously, from the explanations given above, the 10-ampere meter is equally sensitive at all loads,

and it is, consequently, unnecessary to make such a subdivision of capacities with this meter. If placed in a $2\frac{1}{2}$ -ampere installation it possesses the same accuracy, and has the advantage of not requiring to be changed should additions to the number of lamps take place. Figs. 241 and 242 show the appearance of the meter when open and closed respectively.

The employment of the standard size is further preferable on account of the lower drop in volts at small loads. If used on a $2\frac{1}{2}$ -ampere load the drop is only .25 volt; if on 5-ampere, .5 volt; and if on full load it is exactly 1 volt.

The now almost universal use of the maximum-demand system of

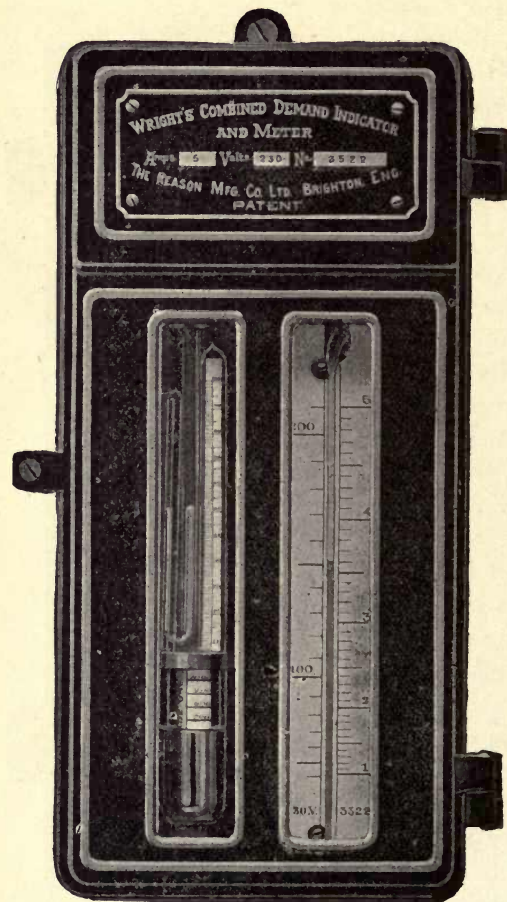

Fig. 243.—Wright Meter and Demand Indicator Combined (Door shut)

charging confers great value on a combined instrument (figs. 243 and 244), viz. meter and demand indicator.

Although the drop of pressure in the demand indicator is comparatively small (.4 volt at full load in the 10-ampere capacity) it is sometimes complained of, and any means of reducing it is naturally desirable.

With this object in view the meter and indicator are electrically connected up, so that the heating resistance of the latter serves as part of the shunting resistance for the former, and the loss of pressure is no greater than with the meter alone. The total

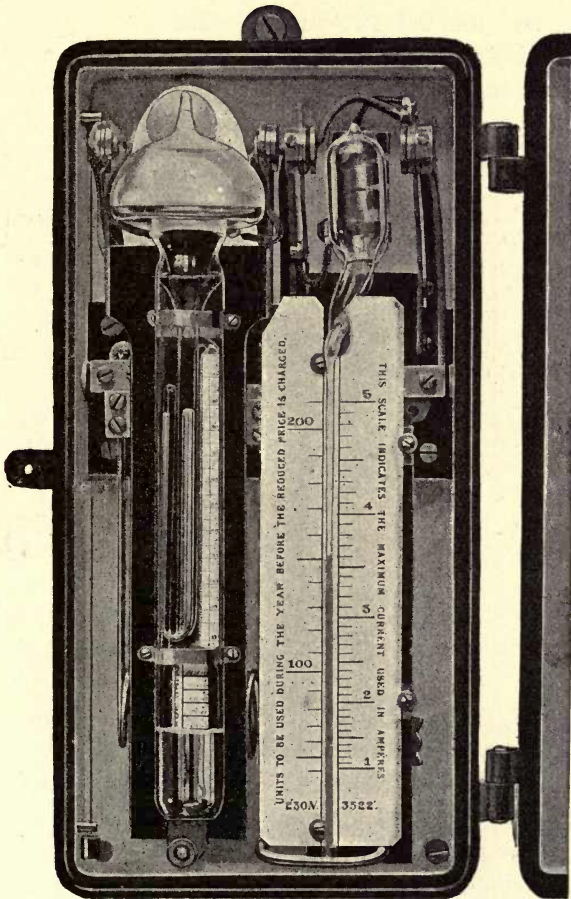

Fig. 244.—Wright Meter and Demand Indicator Combined (Door open)

resistance causing the drop of pressure (which is limited to 1 volt) is made up of the heating coil of the indicator together with an adjustable resistance of platinoid wire similar to that in the ordinary type.

The following additional advantages are secured by the combination. It is exceedingly neat, simplifies wiring, and economizes

space in the consumer's installation. The combined instrument has also the merit of being cheaper than its two components together.

The meter can be easily adapted for three-wire installations, where they are carried out on the plan usually employed in this country, of two distinct two-wire circuits.

The installation is divided into two approximately equal sections, the neutral wire being split for this purpose. At the

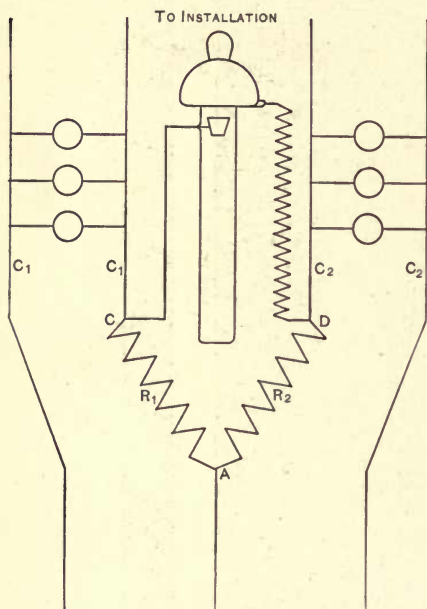

Fig. 245.—Principle of Wright Three-Wire Meter and Connections to the Circuit

point of splitting A, fig. 245, two low resistances, R_1 and R_2 , are inserted of exactly equal value. The electrolytic cell, with its compensating resistance, is connected across the two farther ends (C and D) of these resistances. When R_1 is equal to R_2 the current through the cell will be proportional always to the sum of the currents C_1 and C_2 in the two halves of the installation. Thus the total difference of potential between C and D is $C_1R_1 + C_2R_2$, or, when $R_1 = R_2 = R$, it is $= R(C_1 + C_2)$. Hence the current through the cell, and therefore its readings, will be exactly proportional to the sum of the two currents.

All the working parts are enclosed in a strong cast-iron case, enabling it to withstand ordinary external wear and tear. The platinoid resistance is run at a very low current density, and may thus be subjected to a considerable overload, or even a momentary short circuit, without damage. Electrically, therefore, its main circuit is very permanent.

The chemical stability of the constituent parts has been thoroughly proved by long experience. The electrolyte is working under the precise conditions which ensure its permanence, *i.e.* in presence of mercury. As it is never exposed to atmospheric effects, no chemical change can occur. The successful working of

the meter is thus guaranteed for an indefinite period without repairs or attention.

The Wright Demand Indicator

In connection with the supply of electrical energy, the employment of the so-called Demand Indicator, for determining the price



Fig. 246.—Wright's Demand Indicator (Door shut)

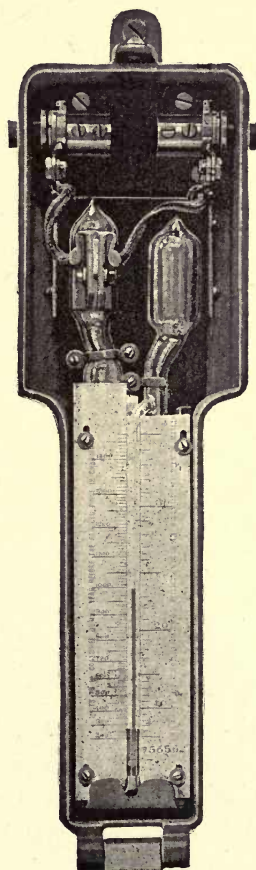

Fig. 247.—Wright's Demand Indicator (Door open)

to be charged, is now becoming so general that a description of a well-known form of indicator is desirable.

It is obvious that the ordinary Maximum Recording Ammeter cannot measure the consumer's "maximum demand". By this

expression is meant, broadly, the *steady load* which a consumer has during the time of maximum load at the central station. Small variations that arise through the switching on of extra lights for a few moments, or the starting up of a motor, should not be recorded. These restrictions at once forbid the use of an instantaneous ammeter, and point to the necessity for a recording instrument which is sluggish in its action, and unresponsive to rapid fluctuations in the consumer's load.

The Demand Indicator invented by Mr. Arthur Wright, and employed in the method of charging that bears his name¹, realizes

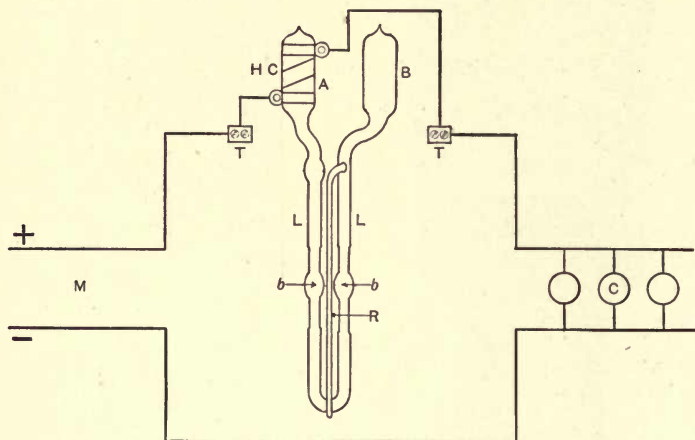

Fig. 248.—Principle and Connections of Wright's Two-Wire Demand Indicator

this desideratum, and it may be briefly described as an instrument for measuring the average maximum value of the consumer's load in lamps, or in amperes, when all accidental inequalities have been smoothed out. Figs. 246 and 247 show the general appearance of a demand indicator with door closed and open respectively.

In principle the instrument is practically a differential recording thermometer. It consists, as seen in fig. 248, of two bulbs, A and B, of approximately the same size, connected by a U-tube LL filled with a very hygroscopic liquid, and provided with a third tube R to which the scale is attached. This special liquid is employed, in order that the air in both bulbs may always be kept free from aqueous vapour. The current taken by the installation is carried through the heating coil HC which is wound on the left-hand

¹ *The Electrician*, vol. xxxiv, p. 700; vol. xxxvii, p. 538; vol. xxxix, pp. 256 and 280.

bulb and connected to the terminals TT of the indicator. The heat produced gradually causes the air to expand, and to depress the column of acid in the U-tube LL, with the result that it rises in the other limb and slowly flows over into the reading-tube R. The height to which it finally rises is an indication of the maximum strength of the current which has passed through the coil. On account of the employment of the thermal principle, the indications are accurate for continuous or alternating currents of any periodicity, irrespective of how the instrument was originally calibrated. Each scale is drawn from actual tests, so that slight differences in the size of the tubing can be allowed for.

To reset any instrument, all that has to be done is to tilt the board carrying the tubes about the hinged terminals, and to allow all the liquid to flow completely out of the reading-tube into the right-hand bulb. The operation, which occupies only a few seconds, is precisely similar to that illustrated in fig. 234.

It is necessary, just as in thermometer-making, to *anneal* the tubes thoroughly, so that the various parts may be freed from internal stress, which might affect the calibration. This process is carefully carried out, and the possibility of secular changes can thereby be entirely eliminated.

The tubes are constructed with a number of traps, *bb*, in each limb, to prevent the passage of air from one bulb to the other during railway or sea transit. Recently, this arrangement has been further perfected, so as to ensure that no transference of air takes place, even when the instruments are reset while hot, or while a current is passing through them. On a long voyage, or when the packing-cases are carelessly handled, the distribution of the air may be altered in a few instances, but the instruments can be easily

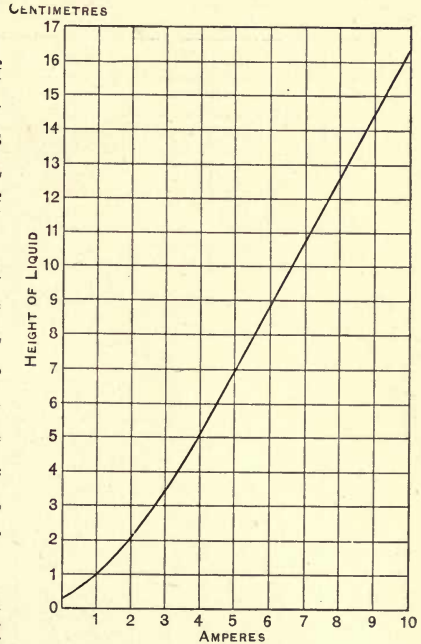

Fig. 249.—Calibration Curve of a 10-Ampere Demand Indicator

readjusted. It is therefore always advisable, after transit, to pass a current through them at about quarter load to make sure that they are in perfect order.

When it is remembered that the Demand Indicator measures the most important part of the consumer's bill, it will be realized that a high degree of accuracy has to be obtained, and the utmost care is paid to this point. The scale is very long and open in

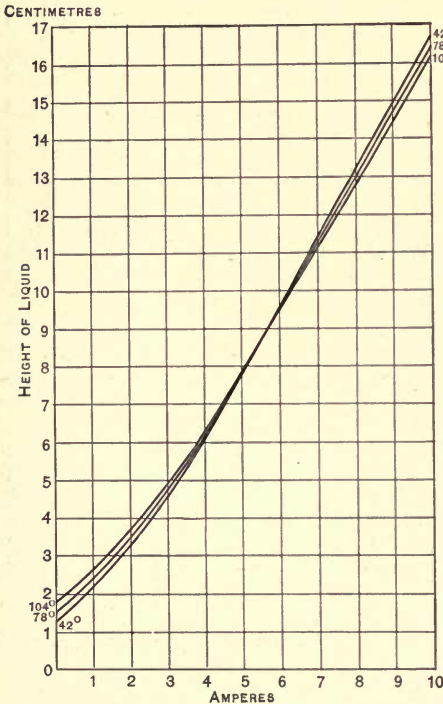

Fig. 250.—Curves of Temperature Error

the working range of the instrument, which is from full load down to one-fifth, or in the 10-ampere size from 10 to 2 amperes. The calibration is not carried below this value, as the scale contracts somewhat, with a corresponding diminution of sensitiveness. This is seen in the curve, fig. 249. On it is also noticeable the great sensitiveness of the ordinary readings. The curve is practically a steep, straight line, and as there is no discontinuity in the registration, there is freedom from the large percentage error, which is bound to exist, where a record is made by sudden steps. The standard sizes are so arranged that, by

using an instrument of suitable capacity, the same sensitiveness and accuracy can be secured for any load to be measured.

At first sight, it might appear that the instrument would be affected by variations in the temperature of the surrounding air. The fact, however, that *both bulbs* are subjected in the same degree to any change of temperature, reduces this error to a very small amount. Like the differential thermometer, it is only the *difference in temperature* between the two bulbs that is registered. The smallness of the error can be seen from the curves, fig. 250,

which illustrates calibration curves taken at three widely divergent temperatures. Except beyond the working range of the scale (*i.e.* below fifth load) and for very unusual variations, the error is negligible. No correction need be applied under the usual working conditions and at ordinary temperatures.

Reference has been made above to the fundamental importance of the sluggishness of registration, so as to annul the effect of accidental increases of load, and to avoid penalizing a consumer, by charging him on more than his actual steady maximum load.

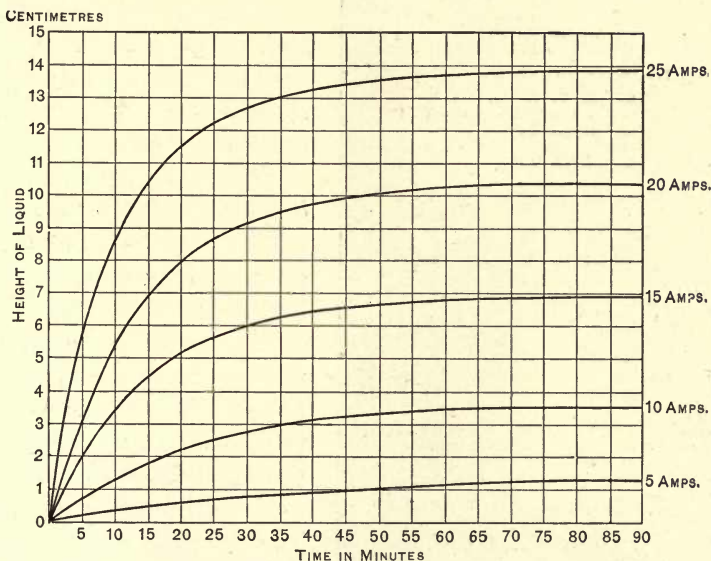

Fig. 251.—Time Curves of Demand Indicator

For an installation of incandescent lamps, the standard instrument is sufficiently slow in its action, but for a motor load, or an arc-lamp load, a greater sluggishness may be desirable. This is obtained by accentuating the characteristic sluggishness of the instrument, which, of course, depends on the specific heat of the coil, the glass bulb, and the enclosed air. An insulated cylinder of iron is placed between the coil and the bulb, and its extra capacity for heat causes the instrument to record as slowly as may be required. Five curves, showing the gradual way in which the reading is ultimately arrived at, are shown in fig. 251.

There is a peculiar and valuable property in the thermal

sluggishness, which cannot be obtained by the employment of any other principle. After a current has passed for some time and is stopped, the instrument gets quite cold, and a subsequent current requires the full time interval to heat the parts and to produce a steady temperature. There is thus no danger of a current a little higher than a former one, but of short duration, causing an abnormally high registration. This is what happens in instruments with mechanical retardation of the reading; and, in practice, it is found that all such instruments are little better than instantaneous ammeters.

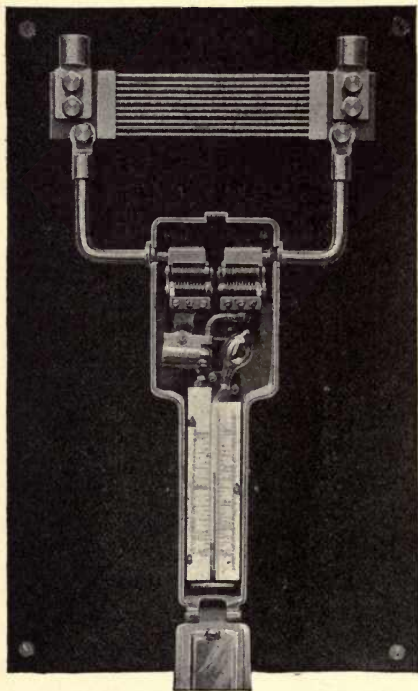

Fig. 252.—Shunted Type of Demand Indicator

The same effect may be expressed in other words, by saying that the sluggishness of the instrument always goes back to zero.

The method of connecting up the demand indicator in two-wire installations is, simply, to insert it in either of the main leads, at some suitable spot close to the meter. The direction of the current is immaterial.

The indicators are made in various sizes up to 1000 amperes. The range in each

size is fivefold, or, in other words, the lowest reading marked on the scale is one-fifth of the full load.

The two-wire indicators are all of the same construction up to 35 amperes, except for the difference in the heating coils. Beyond this size their current-carrying parts are made proportionately heavier, or they may be shunted. Above 100 amperes capacity the shunted type is invariably used, and is illustrated in fig. 252.

The drop of pressure in any instrument is very small, and, for sizes above 10 amperes, it can be ignored. This is due to

the fact that each size requires, practically, the same amount of heat energy to give a full reading, and, consequently, the drop in volts is less, the larger the capacity.

The subjoined table gives full particulars of these values for all capacities:—

Full Load Capacity.	Drop at Full Load.	Average Energy Used.
5 Amps.	1 Volt.	5 Watts.
10 "	·5 "	5 "
15 "	·46 "	7 "
25 "	·28 "	7 "
35 "	·25 "	9 "
50 "	·18 "	9 "
75 "	·15 "	10 "
100 "	·13 "	13 "

A considerable margin of safety exists between the maximum load current in the heating coil and its fusing current. Sometimes it happens, however, with indicators of 3 and 5 amperes capacity, in the case of a bad short-circuit on 230 volts, that an illustration is given of the phenomenon of several fuses blowing simultaneously, and the indicator strip will melt, as well as the protecting fuse, if this is too heavy.

This danger is now guarded against by the use of a metal of great mechanical strength and very high specific resistance, which allows the strips to be made of almost twice the cross section of platinoid for the same drop.

The table of safe carrying currents is given below:—

Normal Full Load Amperes.	Solder Melts with	Strip becomes Red Hot with	Strip Fuses with
2½	11 Amps.	11·5 Amps.	22 Amps.
5	17 "	19 "	37 "
10	30 "	32 "	47 "
15	46 "	53 "	85 "

In measuring the maximum demand of a three-wire installation, it is incorrect to use two separate indicators and to add their readings. Such a procedure is applicable to integrating meters, but where the demand of the two sides together (when this is a maximum) has to be measured, some other arrangement must

be adopted. For this purpose Mr. J. R. Dick has designed an instrument, which measures the maximum demand of a three-wire installation as accurately as that of a two-wire. The principle of this is indicated in fig. 253.

It is obviously unfair to charge a consumer on anything but his

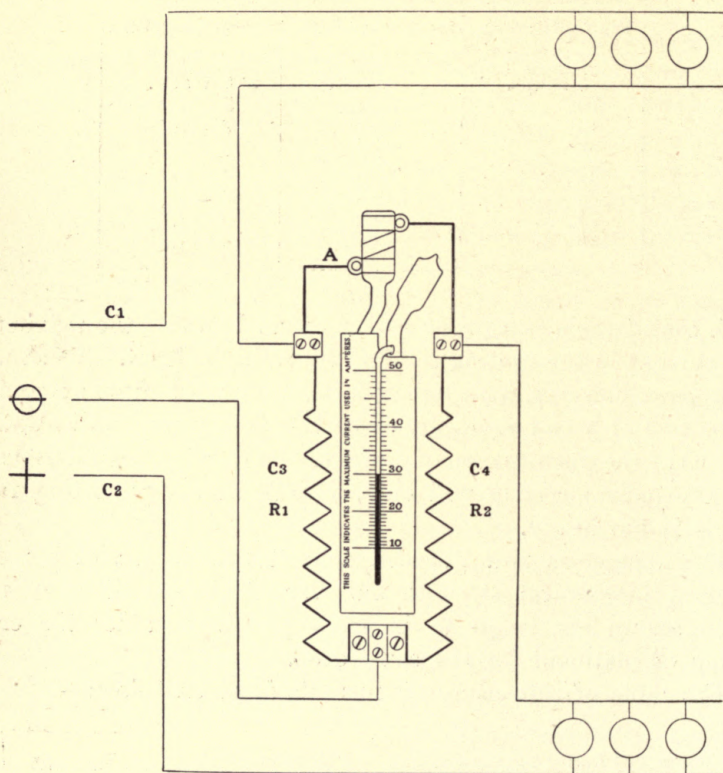

Fig. 253.—Connections of Three-Wire Demand Indicator

true demand, as it is entirely for the convenience of the Central Station that his installation is connected on the three wires.

It will be seen that the method is to divide the neutral wire, and to insert two equal resistances R_1 R_2 in the branches, across the ends of which the indicator strip is connected. The resistances are of very small amount, and the total drop is less than with the former two-wire arrangement.

Referring to the accompanying figure 253, where C_1 and C_2 are the currents on negative and positive sides, A the current through

the indicator strip of resistance r ; C_3 , C_4 , the currents in the branches each of the same resistance R .

$$\begin{aligned} C_3 R + C_4 R &= A r. \\ \text{But } C_3 &= C_1 - A, \\ \text{and } C_4 &= C_2 - A. \\ \text{Thus } R (C_1 - A + C_2 - A) &= A r, \\ \therefore R (C_1 + C_2) - 2 A R &= A r, \\ \therefore C_1 + C_2 &= \frac{A (r + 2 R)}{R}. \end{aligned}$$

That is, A , or the reading on the demand indicator, is always directly proportional to the sum of the positive and negative currents. This, of course, holds good for maximum values of these currents, which is what it is desired to measure.

In addition to the gain in accuracy, considerable economy is effected by the employment of the three-wire instrument in place of two single indicators.

They are made in the same sizes as the two-wire type. Fig. 254 shows one of these three-wire indicators with door removed.

The demand indicator is, of course, equally accurate on alternating or continuous current. It is interesting to note that, the capital charges being almost all independent of the power factor, the value of the current in amperes is the true criterion of the proportionate amount of the consumer's standing charges, and not his demand in true watts.

This will be clear when it is remembered that the mains and all the plant, with the exception of boilers, are designed for a given output in amperes, and therefore all customers should pay in proportion to their demand in amperes.

For the measurement of heavy alternating currents, we find that many engineers prefer to use a transforming device instead of a shunt, on account of the small amount of energy required, and of the facility with which the calibration can be made.

It is only necessary to test a small capacity indicator, and to associate with it a transformer of a known ratio.

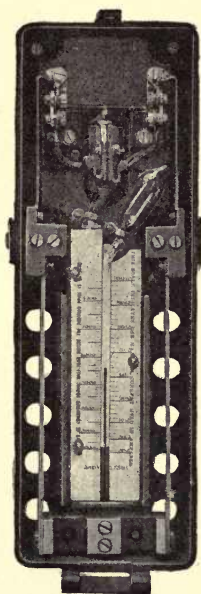

Fig. 254.—Wright Three-Wire Demand Indicator (with Door removed)

An illustration of such a combination, to measure up to 750 amperes alternating, is given in fig. 255.

Special Uses of the Demand Indicator.—In addition to its use as a tariff guide, the Demand Indicator may be employed in other fields. Its readings may be made to serve the useful purpose of maintaining a perfect balance between the two sides of a three-

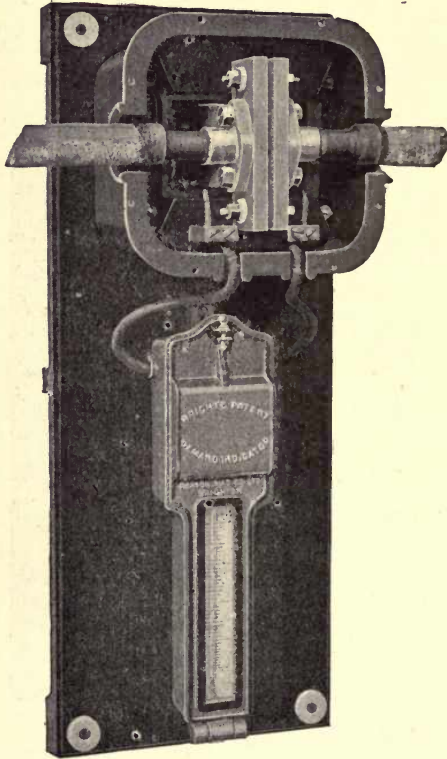

Fig. 255.—Transformer Demand Indicator

wire system. A special book must be kept in which the consumers are classified according to districts and streets. They are further arranged into classes in accordance with the character of their loads. The sum of the demands of each class, connected on the positive side, must equal that of the same class on the negative side. The proper polarity of each new customer can then readily be determined. As the actual demands differ widely from the connected loads, the readings of the indicators furnish the only means of avoiding bad regulation of pressure due to want of balance, and, in scattered areas or on long distribution cables, their use is extremely valuable.

When one or more transformers are installed in a sub-station, it is always desirable to measure the maximum output of each, so as to prevent the possibility of overload. For this purpose, it is convenient to have a Demand Indicator connected in series with each transformer. Its readings will show when the load is approaching the limit of safety, and when a greater capacity must be installed.

The instrument may either be of the shunted type or trans-

former type on the low-tension side, or a smaller one may be placed on the earthed conductor of the high-tension system.

In many cases, also, the determination of the maximum load on a feeder, or distributor, is of great importance, as thereby excessive losses of pressure can be guarded against. For this purpose the Demand Indicator can be readily adapted.

A function of an analogous kind is fulfilled by the indicator, when placed in series with a motor used for workshop driving. The readings afford information as to whether the motor is overloaded, or whether a smaller motor would do the same duty with, naturally, a greater economy. By using a combined instrument, the cost of the power taken by each shaft or machine can also be measured. The extra outlay is well repaid by the data obtained regarding the working of each motor.

Various methods are adopted for charging customers having a demand for power during daylight hours only. The common aim of these methods is to charge as low a price to this highly profitable class as can consistently be done. Some engineers argue that, because, in general, this kind of load is practically over before the lighting begins, a much lower initial price may usually be charged. In other words, they consider that the main part of the standing charges is paid for by the lighting consumers, the day-user being treated as the purchaser of a by-product, and debited with only a small proportion of the standing charges of the plant, which is required in the evening for the lighting consumer.

This method is not so sound as to sell all electricity, for whatever purpose required, on the same tariff.

The latter is an embodiment of the principle that all consumers contribute to the peak, the sum of the demands being modified by the value of the diversity factor. But, if the consumer with a true day load never encroaches on the peak, he should be supplied at the lower rate, without paying any part whatever of the standing charges.

The demand indicator, together with a cut-out switch, affords a perfect means of differentiating such a load from that which is subject to the burden of the standing charges, and the arrangement is shown in fig. 256.

In the diagram it will be seen that the action of the time switch, which is driven by a self-winding electric clock, is to put the demand indicator in circuit only during peak hours, *i.e.* from

sunset to 10 p.m. The switch closes the contacts A A during the above hours, thus causing the demand to be recorded. During the day, it closes the contacts B B, thereby cutting out the demand indicator.

The addition of the cut-out switch does away with the only

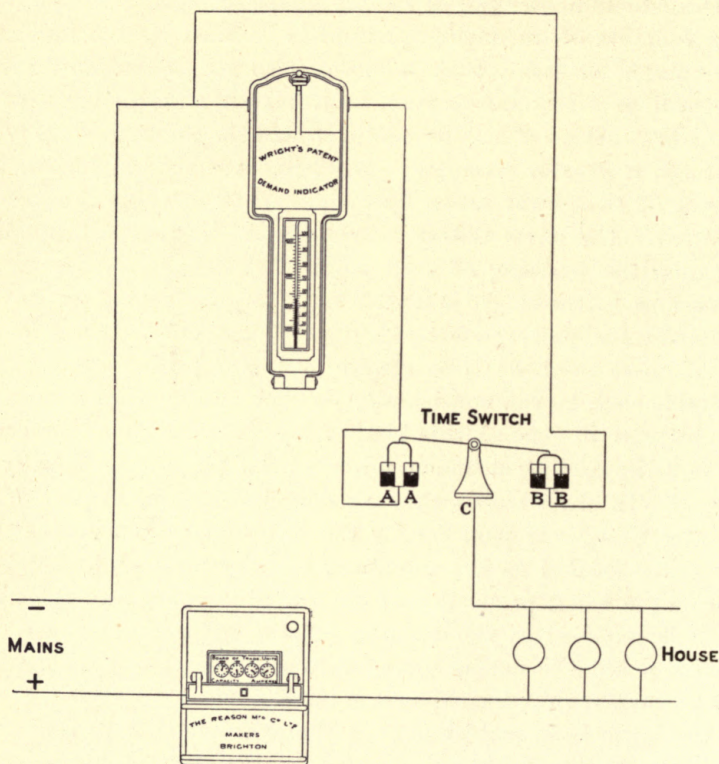

Fig. 256.—Connections of Time Switch and Demand Indicator for Day Loads

valid objection which has hitherto been raised against the "Wright" method of charging, *i.e.* its ineffective dealing with the true day-load.

The Siemens Electricity Supply Meter (For Continuous Currents)

This instrument, made by Messrs. Siemens Bros. & Co. of London, belongs to the class of periodic integrating electricity meters, in which a form of clock is used in conjunction with the rest of the mechanism. This type of meter, intended for use with

direct currents, can be made in the form of an ampere-hour or watt-hour meter, and, with a slight modification, as a time indicator for showing the period for which an electric plant is in operation.

The form now under consideration consists of a moving-coil instrument reading amperes or watts direct, in conjunction with a registering mechanism driven by electricity, which actuates a counting train at intervals of about $3\frac{3}{4}$ seconds, and propels it by an amount corresponding to the deflection of the ammeter or wattmeter. In the case of the ampere-hour meter, the ammeter part of the instrument is of the usual moving-coil permanent-magnet type. In wattmeters, however, the field is produced by an electro-magnet, the coils of which are included in the volt circuit.

In this case there is a contact, worked by the clock mechanism, which momentarily short-circuits the coils of the electro-magnet just before the counting train is actuated. This is in order that the reading registered shall be that corresponding to a point on the rising part of the magnetization curve of the iron, so that errors due to hysteresis, which would otherwise occur through readings being taken sometimes on a rising and sometimes on a falling voltage, are obviated.

A separate scale and pointer are provided for the ammeter or wattmeter, so that amperes or watts can be read off at any time, saving the use of a separate instrument.

A general view of the meter, with cover removed and part of the recording dials cut away to show the interior more plainly, is shown in fig. 257, while fig. 258 shows the general appearance of an ampere-hour meter of this type with cover on.

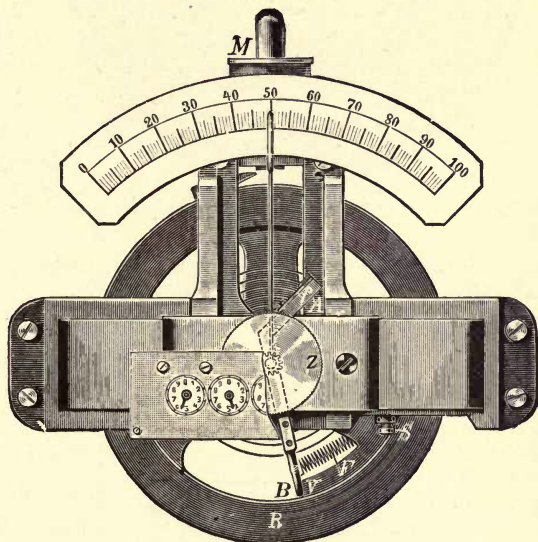

Fig. 257.—Interior of Siemens Direct-Current Meter

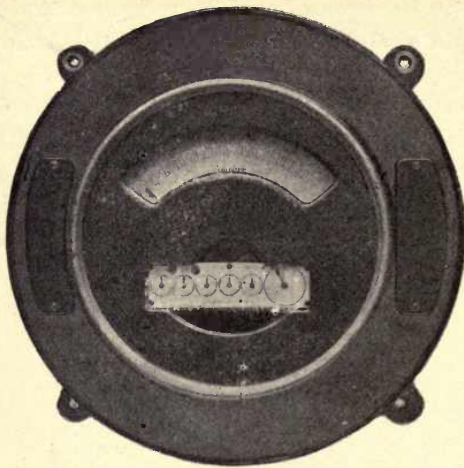

Fig. 258.—General View of Siemens Direct-Current Meter

The balance-wheel R possesses a shoulder v, which bears against the arm B. The spring F allows the wheel to swing on after the arm B has come against the stop, which prevents it carrying the pointer back beyond zero.

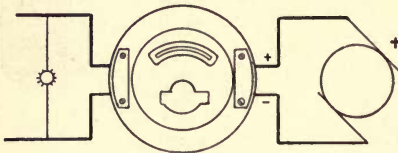

Fig. 259.—Connections of Siemens Meter (with Internal Shunts) to Two-Wire Circuit

The counting train is worked by a disc Z, with a serrated edge, over which is a small spring continually moving backwards and forwards, driven by the balance-wheel; while moving in one direction this spring just does not touch the disc; but at some point in its return journey meets a projection on the pointer of the ammeter (or wattmeter), which causes it to engage with the disc and

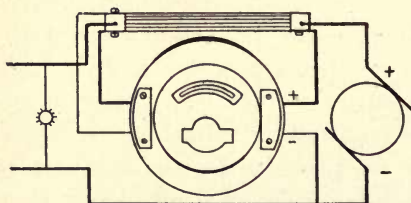

Fig. 260.—Connections of Siemens Meter (with External Shunts) to Two-Wire Circuit

propel it through an angle corresponding to the deflection of the pointer. At the same time the pointer is carried back to zero, where the disc is freed again. These operations are carried out

The clock mechanism consists of a heavy balance-wheel R, shown in the mid-swing position in fig. 257, delicately poised on the ball-bearings. This receives occasional impulses from an electro-magnet M connected with the volt circuit, and which will maintain a constant speed in spite of large variations of voltage, amounting to as much as 15 per cent in either direction.

A is rigidly connected to B, the whole system being pivoted concentrically with the balance-wheel R.

A is rigidly connected to B, the whole system being pivoted concentrically with the balance-wheel R.

propel it through an angle corresponding to the deflection of the pointer. At the same time the pointer is carried back to zero, where the disc is freed again. These operations are carried out

at every swing of the balance, so that readings are taken every $3\frac{1}{2}$ seconds and added up by the counting mechanism. We can see at a glance that the clock is working properly by the motion of the pointer, which moves to and fro between the zero and the reading corresponding to the amperes or watts flowing in the circuit. These meters can be affixed to any wall, and do not require to be levelled up, nor will they be affected by vibration.

Up to 100 amperes, the low-resistance shunts used with these meters are placed inside the case; but, for higher currents, the meter is connected to an outside shunt by small leads. In this connection it may be noted that leads having the same resistance as those used in the calibration must be employed, otherwise an error will result.

A separate high resistance is provided for meters to be employed on circuits of 250 volts and upwards.

Fig. 259 shows the diagram of connections in the case of ampere-hour meters intended for use on two-wire system with shunts, and fig. 260 indicates them when an outside shunt is used.

In the case of meters on the three-wire system, fig. 261 shows the connections for an instrument with self-contained shunts, and fig. 262 with outside ones.

It will, of course, be noticed that the meter is connected in the outers.

Kelvin's Electricity Supply Meter

This meter, made by Messrs. Kelvin & James White of Glasgow, belongs to the class of *periodic integrating* electrical instruments, and is an energy meter, measuring the energy in Board of Trade units, which are absorbed in any given circuit. The original form

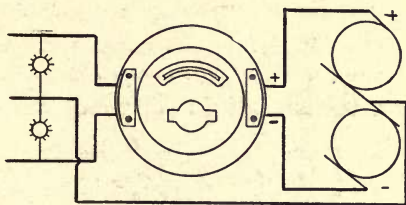

Fig. 261.—Connections of Siemens Meter, with Internal Shunts to Three-Wire Circuit

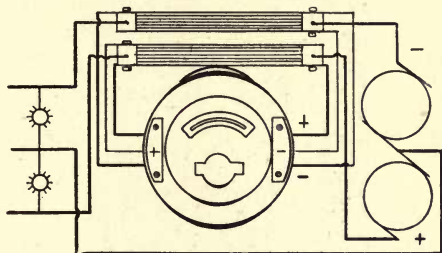

Fig. 262.—Connections of Siemens Meter, with External Shunts to Three-Wire Circuit

of the meter is shown in fig. 263. It consisted of a self-winding clock, arranged in combination with an electro-magnetic system to record, at periodic intervals, the vertical displacements of a small rod, these displacements being exactly proportional to the current passing through the main solenoid to the lamps.

Considerable improvements

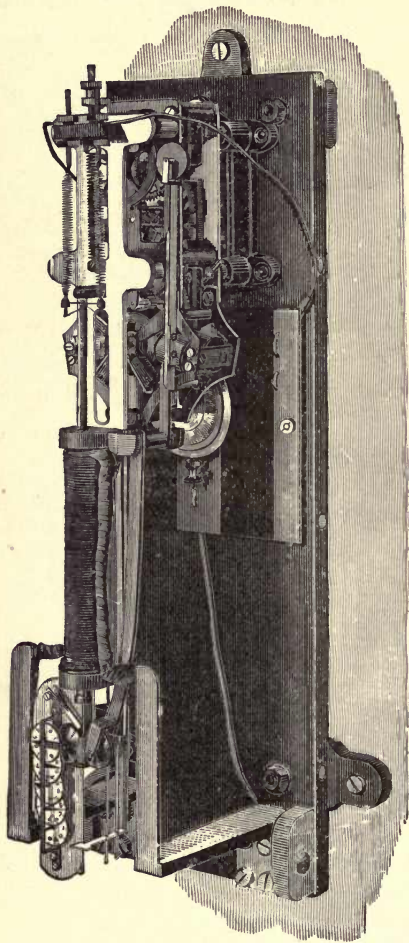

Fig. 263.—Interior of Kelvin Meter (early pattern)

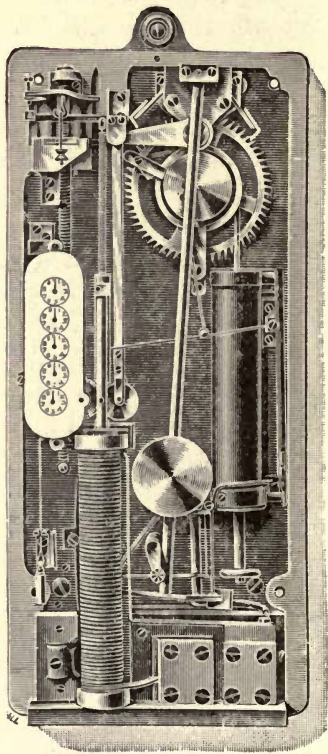

Fig. 264.—Interior of Kelvin Meter (present pattern)

have recently been made on the original form, principally in the driving mechanism, and these improvements have greatly simplified the construction of the meter.

Fig. 264 shows the internal view, with cover completely removed.

The electrical part consists of a main solenoid, which carries

the current to be measured. Into this is entered a long thin plunger of very soft iron suspended from a specially-prepared spiral spring. The upper end of this spring is supported on one end of the beam of a small balance, which is adjusted in connection with the spring, to allow the plunger to be pulled down by an amount almost exactly proportional to the current passing in the

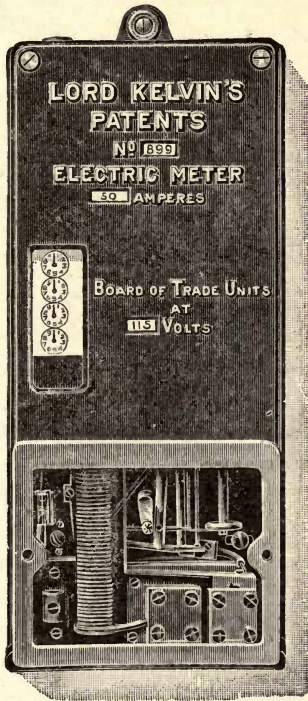

Fig. 265.—Kelvin Meter with Inspection Lid Removed

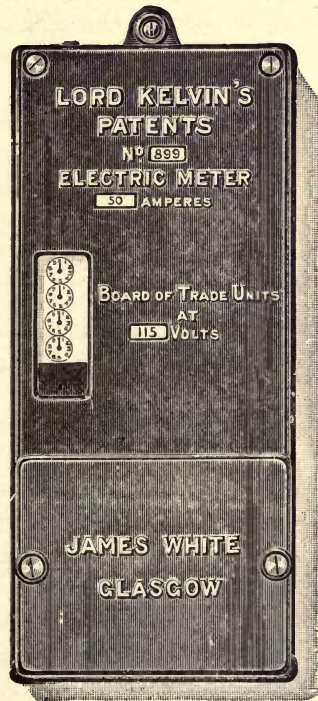

Fig. 266.—Kelvin Meter after Installation

main solenoid. The plunger is guided at the top and bottom so that it passes between two flat rollers. One of these is geared to the recording dials, and the other is on the end of a lever. At periodic intervals of about one minute this lever is moved by a revolving cam, causing the plunger to be pressed against the two rollers. Immediately following this motion, a lifter acted on by a crank begins to rise, lifting the plunger to its zero position, and making a record on the counter in proportion to the current passing in the coil. The zero position of the plunger is adjusted so that the lifting-bar touches a fixed stop and the disc on the plunger at

the same time. The driving mechanism is exceedingly simple, and entirely automatic in its action. It consists of a drum and scape-wheel on the same spindle, which is made to revolve by means of a small cylindrical iron weight. This weight is connected to an arm carrying an eccentric quadrant of steel, which grips against the drum when the weight is going down. When the weight has fallen to nearly the bottom of its range, it presses down a contact, sending a current through a solenoid into which the upper end of the weight is entered, causing the weight to be raised and breaking the contact again. The speed of rotation is regulated by means of a pendulum, and is quite uniform and independent of the current passing in the main coil.

Fig. 265 illustrates the meter with main cover in position, but with the inspection lid removed, and fig. 266 shows the meter completely covered in and ready for fixing in position.

The Electrical Co.'s Electricity Meter (For Direct Currents only)

This is essentially an energy (watt-hour) meter and not a quantity (ampere-hour) one, and will only work with continuous currents. It is applicable for use on two- and three-wire circuits, registering the energy consumed direct in Board of Trade units. All energy motor meters have the one principle in common, of measuring and integrating the number of revolutions of a movable-shunt coil, opposed in effect to that of the main-series windings of the meter, and rotating with an angular velocity proportional to the main and shunt currents. The chief difficulty is in conducting the current to the moving parts of the instrument. Hitherto this has been effected by the use of commutators and brushes which rub on them, thus introducing frictional resistances of a variable nature. After a time the rubbing surfaces, however well made, become mechanically and chemically acted on by dust and damp, thus affecting the accuracy of the meter.

The meter is of the oscillating type, *i.e.* the shunt coil does not rotate, but swings backwards and forwards between fixed positions in the magnetic field of the main-current coil. The advantage of this arrangement consists essentially in the fact that the current can be conducted to the moving system without rubbing parts by means of two fine metal threads, and that it dispenses with brushes

and commutators, necessary adjuncts of motor meters with a rotating system.

The meter, which is known as the "Small Type" oscillating meter, is made up of two parts, electrically but not mechanically connected. The first is the meter proper (fig. 267), and consists of the main-current coil H , in front of which is the vertical spindle A carrying the moving system. The spindle not only carries the

shunt coil s , but also the contact arm K which reverses the direction of rotation of the moving system by means of the two contact pins K_1 and K_2 , these latter further limiting the extent of the swing on either side.

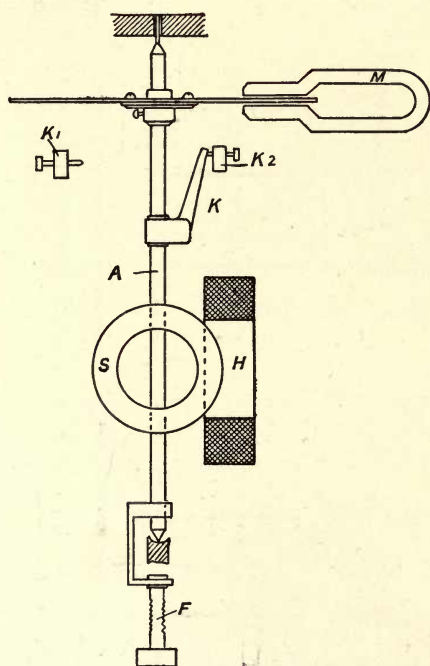

Fig. 267.—Principle of Electrical Company's "Small Type" Direct-Current Oscillating Meter

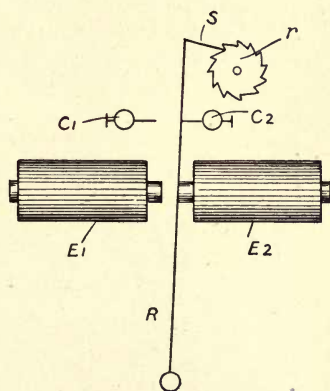

Fig. 268.—Relay Working Recording Mechanism of Oscillating Meter

The current is led to the moving coil from below, as already pointed out, by means of two fine metal threads F , of such a length as to render their torsion practically negligible. The work done in the meter is consumed by the brake magnet M .

The second part (fig. 268) consists of a "relay" in connection with a counting mechanism. The relay has two electro-magnets E_1 and E_2 between which swings the pivoted armature R , the extent of the swing being, as before, limited by the contacts C_1 and C_2 . The motion is transmitted from the relay to the counting mechanism through the pawl s and ratchet-wheel r . The figures of the

CYCLE OF ACTIONS OF "SMALL TYPE" DIRECT-CURRENT OSCILLATING METER

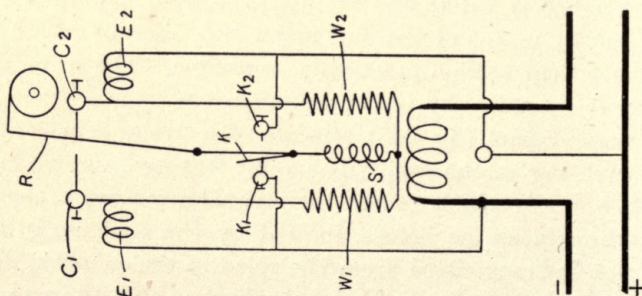

Fig. 269.—Moving Coil s in Parallel with Resistance W_2

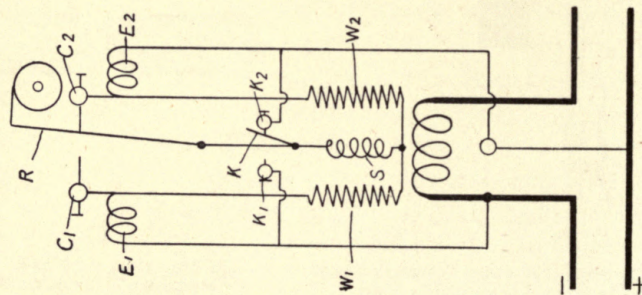

Fig. 270.—Electro-Magnet E_2 Short-Circuited, and Moving Coil s in Parallel with W_2

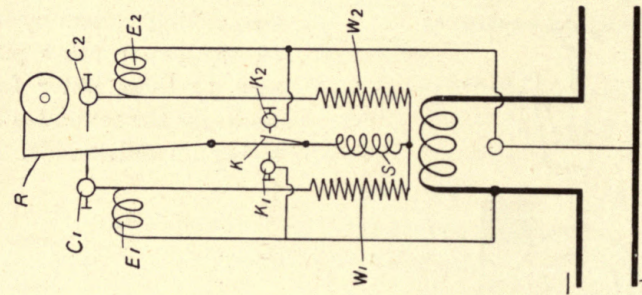

Fig. 271.—Moving Coil s in Parallel with Resistance W_1

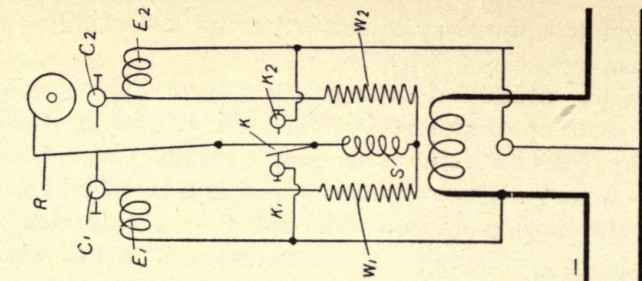

Fig. 272.—Electro-Magnet E_1 Short-Circuited, and Moving Coil s in Parallel with W_1

counting mechanism spring into position, and, being arranged in one single row, the energy consumption can be read off direct in Board of Trade units (the meter constant being unity), so that the consumer can tell at a glance the amount he owes the supply company.

The action of the meter is represented diagrammatically in figs. 269 to 272, and is as follows:—

The armature of the relay is always resting against one or other of the contacts c_1, c_2 . In fig. 269 the contact is shown on c_2 ; and, in consequence the moving coil s is in parallel with the resistance w_2 . The direction of the current in the coil s in this case is such that the contact arm K , move towards the contact pin K_2 . On impinging on the latter the electro-magnet E_2 of the relay is short-circuited (fig. 270), so that the armature of the relay is attracted by the electro-magnet E_1 (fig. 271). The coil s is now in parallel with

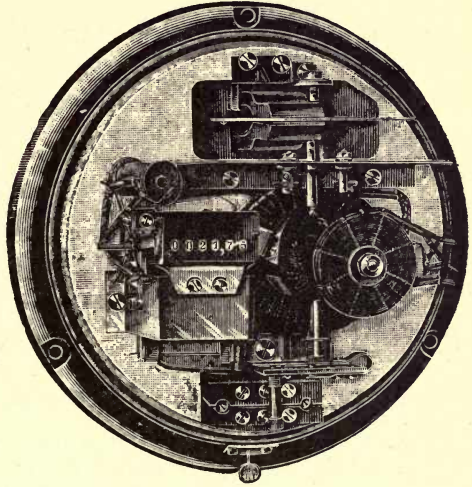

Fig. 273.—Interior of "Small Type" Oscillating Meter

the other resistance w_1 , and the direction of the current in it is reversed.

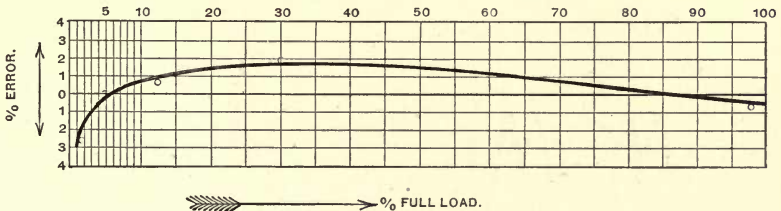

Fig. 274.—Error Curve of "Small Type" Oscillating Meter

the other resistance w_1 , and the direction of the current in it is reversed.

The moving system will now execute a backward swing until K touches K_1 , when the same cycle of operations will be repeated, so that between the moving system and relay there exists a constant interaction, resulting in an "oscillating" motion instead of a

Cycle of Actions of "Large Type" Direct-Current Oscillating Meter

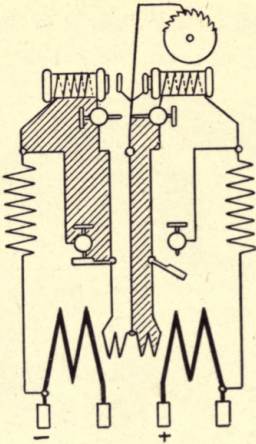

Fig. 275.—Extreme Position of Moving Coil to Left

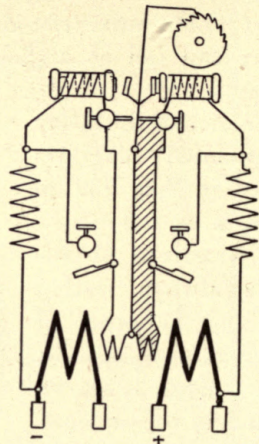

Fig. 276.—Central Position of Moving Coil in Mid-swing from Left to Right

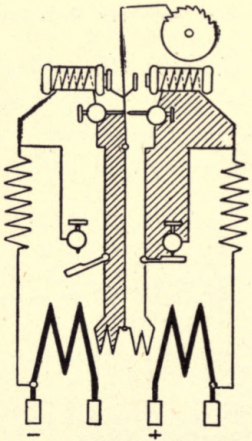

Fig. 277.—Extreme Position of Moving Coil to Right

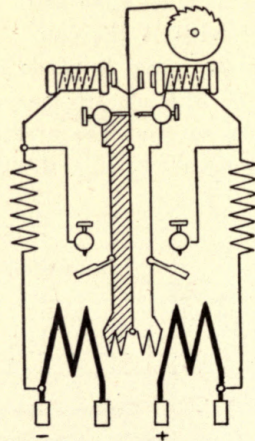

Fig. 278.—Central Position of Moving Coil in Mid-swing from Right to Left

"rotating" one. As the shunt circuit is never interrupted, but only parts of it are short-circuited, no sparking at the contacts can possibly take place, with the resultant elimination of wear, so that the reliability and accuracy of the meter remain unimpaired.

The internal view of this "Small Type" direct-current oscillating meter, which is made for currents up to 10 amperes and voltages up to 500 volts, is shown in fig. 273 with cover removed. The accuracy of its indication is in no way affected by variations of voltage, and these meters are free from idle running on open lamp circuit, even with a 20-per-cent increase in voltage. On the other hand, they will start with 1 per cent of their maximum load.

The shunt loss is constant throughout, and is about 1.2 watt per 100 volts, the loss in the main-series coils at full load never exceeding 8 watts.

The accuracy of the meter is shown by the error curve (fig. 274).

In the direct-current oscillating meters for higher currents, and for use on three-wire as well as two-wire circuits, a slight alteration is made to the shunt and series coils, the latter now being in two equal parts, as shown by the thick wavy line in figs. 275 to 278.

The shunt coil consists of two parts, equal but oppositely wound, each carrying a contact arm which, in conjunction with stops, limits the extent of the swing.

The transition from rotation to oscillation is as follows:—Only one of the two windings of the moving coil is in circuit at one time. Starting from one extreme position, we have the winding at this end in circuit and the other short-circuited on itself. The moving coil gets repelled by the main coils and swings towards the other extreme position, and throughout this half of the

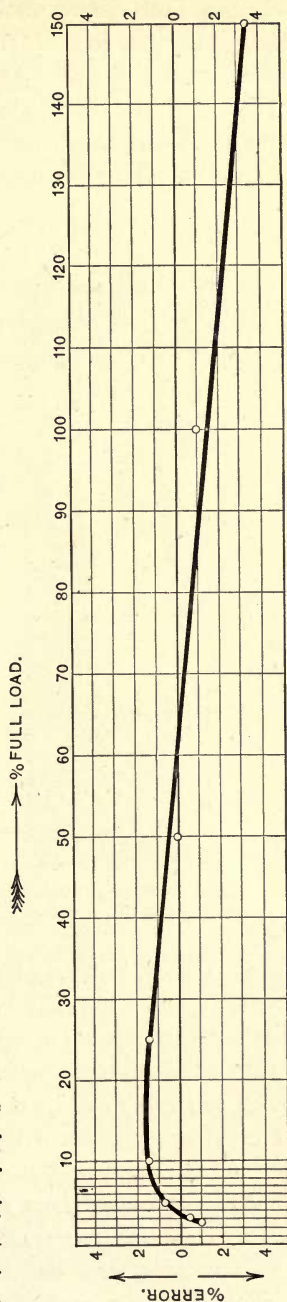

Fig. 274. — Error Curve of "Large Type" Oscillating Meter

oscillation remains operative, the other coil remaining short-circuited. At the end of the swing the first winding gets short-circuited and the other becomes operative.

The short-circuiting and opening of the windings is effected by means of the above-mentioned contact arrangement in connection with another actuated by a relay. The coil now executes a backward swing, the same conditions prevailing, but interchanged as regards the windings.

The cycle of changes is shown in the accompanying diagrams. Figs. 275 and 277 give the extreme positions to the left and right respectively. Fig. 276 is the central position with the coil in the middle of its forward swing, from left to right, and fig. 278 is the central position with the coil in the middle of its backward swing, from right to left.

Three fine metal threads conduct the current to the moving system, and are made of sufficient length to render their torsion negligible. Two are for leading the current to the windings, and the third acts as a common return.

The counting mechanism is controlled by a relay, consisting of two electro-magnets and two mechanically

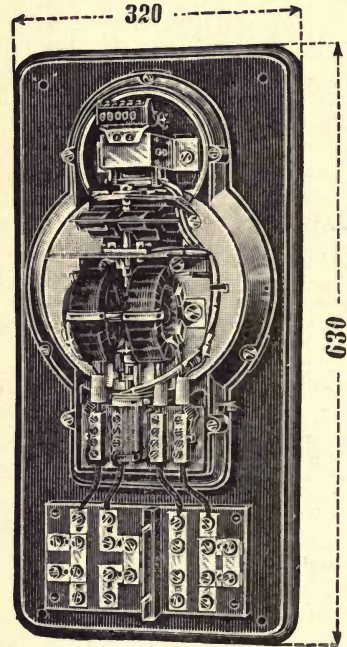

Fig. 280.—Interior of 30-Amp "Large Type" Oscillating Three-Wire Meter

connected, but magnetically insulated armatures, which swing backwards and forwards between the electro-magnets. The armatures carry a pawl engaging a ratchet-wheel, and causing it to advance through one tooth in one complete oscillation. The windings of the relay are in series with the shunt coil and resistances. The moving coil, as will be seen, is independent of the work expended in driving the counting mechanism, and is further independent of extraneous effects, the readings of the meter being quite as accurate for small as for large loads.

The meters can be overloaded 20 per cent without injury or undue heating, and they will stand a momentary overload of

50 per cent (*e.g.* when arc lamps or motors are switched into circuit).

These meters read accurately to within 2 to 3 per cent, from 4 per cent of full load up to full load.

Fig. 279 shows the curve of error of one of them, from which it will be observed that the maximum error occurs at one-tenth full load, and above it up to one-half full load the error diminishes, and vanishes in this region of the scale. For loads exceeding 50 per cent of the maximum it becomes negative, and attains a maximum of about 2 per cent.

Fig. 280 shows the internal view with cover removed of a three-wire meter for currents of 30 amperes in each outer main. It is mounted on a larger base, with special terminal blocks for testing.

Fig. 281 shows the general outside appearance of these meters unmounted on any special base. If C = the true line current at a pressure of V volts and the meter makes N swings in T seconds. Then

if K = the speed constant stamped on the meter cover, *i.e.* the meter makes K swings per minute per 1000 watts,

\therefore 1 swing per minute corresponds to $\frac{1000}{K}$ watts, and $\frac{60 N}{T}$ swings per minute to $\frac{60,000 N}{K T}$ watts.

$\therefore \frac{60,000 N}{K T} = V C$, or $\frac{V C K T}{600 N} = 100$, if the meter is registering correctly. But if this = 98 or 101, the meter reads 2 per cent too low and 1 per cent too high respectively.

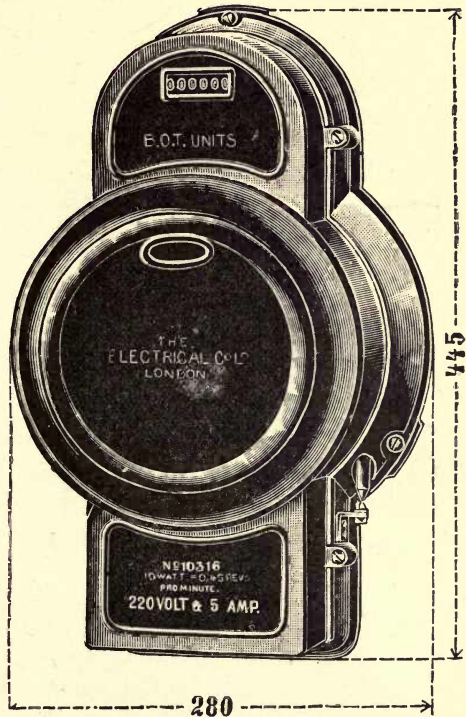

Fig. 281.—General View of "Large Type" Oscillating Three-Wire Meter

The Ferranti Electricity Meter

This is one of the oldest of the meters which have attained commercial success, the first experiments in connection with its production dating back as far as 1883.

Though the principle on which it works can be applied to both direct and alternating currents, the direct-current form is the one

used most extensively at the present day. The alternating-current form is little used, owing to difficulties in the construction and to the somewhat complex relation that exists between current and driving torque.

It is a quantity or coulomb motor meter, but in common with all similar meters of this class it can be graduated in Board of Trade units when used on a constant-potential circuit.

Its action depends on the principle in electro-dynamics, that when a current

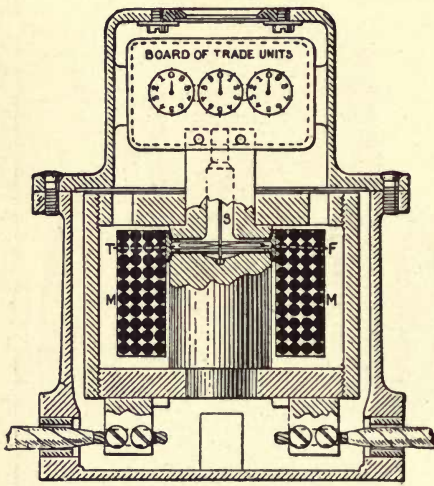

Fig. 282.—Principle of Ferranti Meter in Sectional Elevation

of electricity flows radially in a flat circular trough, containing a conducting liquid placed in a magnetic field, which passes perpendicularly through its flat surface, the liquid will rotate. The rate of rotation will depend on the strength of the current and of the magnetic field, as well as on the controlling force.

Fig. 282 shows the meter in sectional front elevation, from which the very simple construction will be readily understood. It consists of a main solenoid or coil M carrying the main current, and surrounding a central soft-iron circular core, which is in two parts with a narrow air-gap separating them. The coil M, with its split core, is enclosed concentrically in a cylindrical cast-steel box, which not only serves as a containing-case, but also forms a closed magnetic circuit, with the core for the lines of force to flow in.

In the narrow air-gap in the core between the two magnetic poles of opposite polarity thus formed is placed an insulated trough

of mercury T. This trough did, in the earlier stages of the meter, give a good deal of trouble, as the centre and circular side had to be of metal, and the top and bottom of non-conducting material.

The side used to be made of copper or brass, nickel-plated, but as nickel-plating is porous, the mercury soaked through it and ate away the brass or copper at the back, forming an amalgam.

It has now been replaced by a steel ring, made sufficiently thin not to short-circuit the air-gap and thus divert a great many of the lines which should pass through the trough T. Actually, however, this side of magnetic material does divert a small portion of the field, which would otherwise pass through the mercury and be usefully employed in moving the mercury in the meter. But practically the loss of the little energy represented by this is more than compensated for by the great gain in durability. The current enters the mercury at the centre, which is one terminal of the trough, flows through it radially, and out at the rim, which is the other terminal. The motion of rotation of the mercury which results is conveyed to the recording train of wheels by means of a small fan-float F immersed in the mercury and carried round by it, and mounted on a vertical spindle S, which gears into the driving-wheel of the train.

This fan has not only to record accurately the speed of the mercury, but at the same time has to offer very little attraction to the side of the bath, due to the surface tension in mercury. The present form is the result of a series of modifications, and appears to meet every requirement. It consists of a fan, which is made up of two blades of aluminium and two of platinum, and in some cases of four blades of non-magnetic steel. These are so arranged that the weight which prevents the fan and spindle from floating up is partly in the mercury and partly in the air.

By carefully deciding these weights the fan and spindle cause no weight on the jewel when the meter is at work, which is of vital importance in getting the meter to start at small currents, and to avoid wearing the pivots and jewels.

In the case of the direct-current form of this meter, the magnets are energized by the current to a moderate extent, and thus the magnetization is very nearly proportional to the current. In order, therefore, to counteract the small initial statical friction of the meter and get it to start registering with small currents, a fine-wire shunt coil is wound on the central core and connected across

the lamp leads. This produces an initial and constant magnetization which is independent of the current flowing through the meter. This must not be confused with the shunt circuit in energy meters, which plays quite a different part.

In order to make the speed of rotation of the mercury, and therefore of the fan, α to the current flowing through it, a retarding force has to be applied to the mercury, otherwise it would run away and give incorrect registration.

To effect this the insulation covering the pole faces, and forming the top and bottom of the mercury trough, is serrated with a number of radial grooves; the friction of the mercury against these retards the speed with a force α to the speed.

But the driving torque is α to the current; therefore, when the driving and retarding forces balance and the meter runs at some constant speed we have the speed α to the current.

The fan spindle is provided with a tiny worm, cut in a special machine and gearing into a worm-wheel with 100 teeth slightly at an angle. This worm-wheel forms the first of three wheels in a small train at the back of the meter, which are geared 10 to 1, and indexed to form a testing train for calibrating and checking the accuracy of the meter. Since to calibrate on the front dials not only means time but also a considerable amount of current, it is much easier and cheaper to count the rotations of the fan spindle, which is done on this back train of wheels.

This train is swung on a centre (concentric with that of the worm-wheel) which is set accurately in relation to the worm; the train can then be moved about this centre to accommodate the gearing of the ratio wheel and pinion without affecting the accuracy of the relative positions of the worm and worm-wheel.

The ratio pinion and ratio wheel, which are variable, and which are changed after calibration to make the meter read direct in Board of Trade units on the front dial, are fitted to the last wheel of the small swing back train and the first spindle of the front dials.

The mercury used is quite pure, and it is of the utmost importance to keep it clean and free from dust. It is sent in a bottle with the meter when the latter is sent out to any distance. When moved about in a house the meter should never be tilted more than about 45° .

These Ferranti meters, including those for 300 and 600 amperes,

start with about 0.3 of an ampere, and register correctly over almost the entire range, the small loads being registered as accurately as the large ones. And it must be remembered that it is usually very difficult to find a meter that will register the small amounts fully.

The ratio of wheels now used are as follows:—

The worm makes 100 revolutions to 1 of the first wheel,
 the first wheel makes 10 " " " second wheel,
 the second wheel " 10 " " " third wheel,

making a total of 10,000 revolutions of the spindle.

These three wheels are the same for all sizes of meters. The pinion on the staff of the third wheel varies according to the constant of the meter, the usual sizes being 6, 8, 10, 14, 20, 30, 40, 50, and 75.

The fourth or ratio wheel, which gears into this pinion, is interchangeable, and varies from 20 to 110. The ratio wheel and pinion, and also the number of revolutions of spindle per 10 B.T.U., are marked on the back of the train.

A 25-ampere meter is marked 60,000, for $10,000 \times \frac{7\frac{1}{2}}{1} = 60,000$ revolutions of spindle = 1 revolution of hand of unit dial = 10 B.T.U.

The constant, *i.e.* the number of revolutions of the spindle per ampere per minute for 60,000, would be 10. Thus $10 \times 60 = 600$ revolutions per ampere hour, $\frac{600}{100} = 6$ revolutions per watt hour at 100 volts, $6 \times 1000 = 6000$ revolutions per B.T.U., $6000 \times 10 = 60,000$ revolutions per 10 B.T.U. at 100 volts.

For other voltages the revolutions per ampere per minute are proportional; *i.e.* if the constant for 100 volts = 10, that for 105 = 10.5, and 110 = 11.0, all dial wheels are at a ratio of 10 to 1.

The Hookham Direct-Current Electricity Meter

This is a coulomb motor meter, made by Messrs. Chamberlain and Hookham of Birmingham, and so calibrated, for use on constant potential circuits, that it reads direct in Board of Trade units. It has been before the public since 1887 in various forms. The original design involved the use of a commutator, while later forms required a rather larger starting current. By greatly increasing the driving force of the motor and balancing it by a proportionately increased Foucault brake, thereby diminishing the friction relatively,

though not positively, the objectionable features have been remedied in the 1897 pattern of this meter. This, though superseded to some

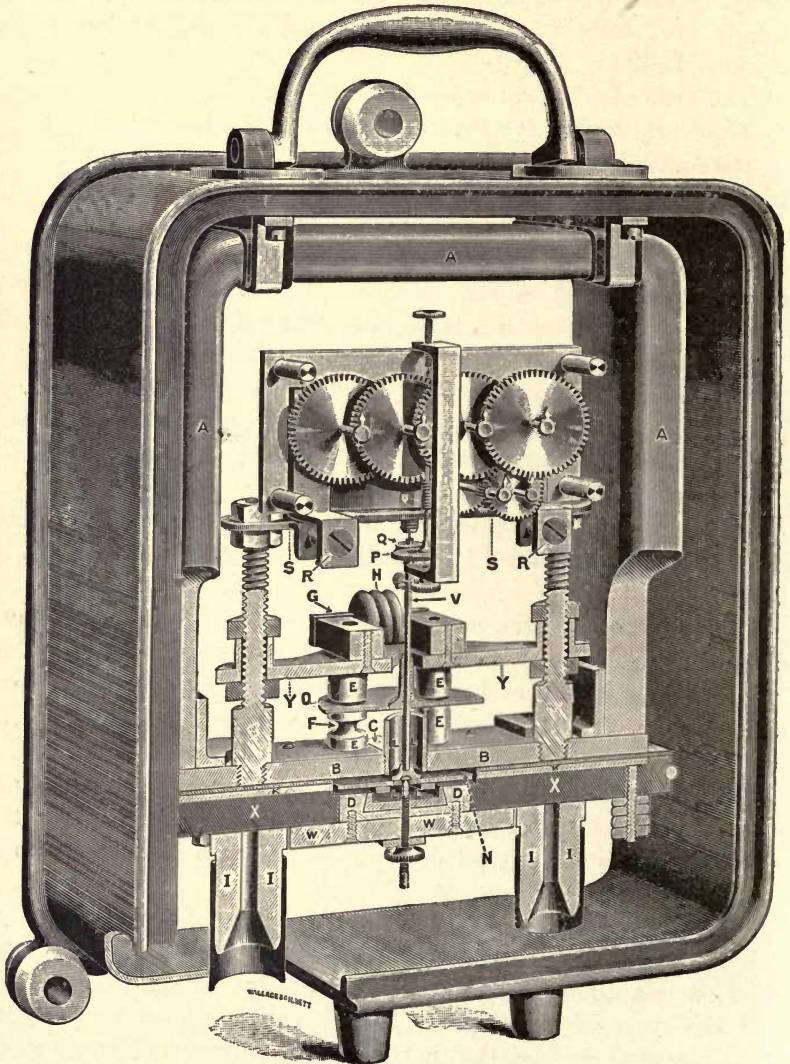

Fig. 283.—Hookham Direct-Current (1897 pattern) Meter in Section

extent by the latest form now being made, is used to such an extent as to make a description of it desirable. By using larger driving and retarding forces, disturbing causes of all kinds are rendered

less important, and the error curve of the meter from, on an average, one-thirtieth full load upwards is practically a straight

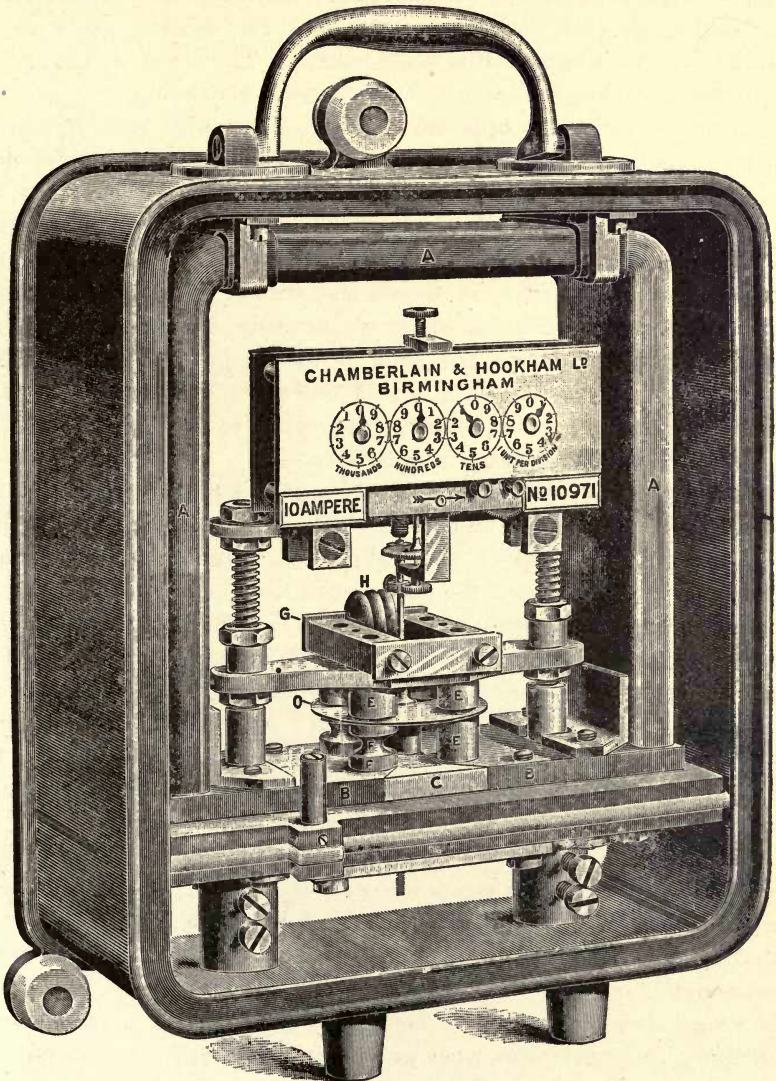

Fig. 284.—Hookham Direct-Current (1897 pattern) Meter

line. A sectional view of the interior of this pattern is shown in fig. 283, and a perspective elevation in fig. 284, from which the construction will be clearly understood. Referring to these figures

it will be seen that a single bar magnet A A of tungsten-steel now replaces the dozen or so of straight magnets which were contained in the brass tube of the earlier form. B B are plates of soft iron continuing the magnetic circuit towards the centre, where it is broken by the insertion of a brass piece C. The lines of force pass downwards through the iron bridge-piece D D, being cut by the armature N twice, in opposite senses. They also pass upwards through the brake pole-pieces E E and the upper iron bridge-piece G. O is the brake-disc; H the correcting coil for fluid friction error; F the reduced saturated neck of one of the brake pole-pieces; K K insulated strips of copper, conducting the current from the terminals I I to the mercury cup L L, in which the armature is immersed and partially floated. The mercury is carefully insulated from the containing vessel, except the ends of the copper strips K K. The armature is slit radially for about one-third of its diameter all round, leaving a continuous area of copper in the centre.

The action of the meter is as follows:—

Owing to the great length of the magnet A A, an intense field is produced at B D, B D. The current flows across the diameter of the disc, being almost entirely confined (by the radial slits in the armature) to the area beneath the pole-pieces, which embrace each about one-third of the periphery of the disc. The armature thus cuts the field twice, instead of once as in the 1892 pattern. Add to this the much greater intensity of the field, and also that the arrangement allows of the pole-pieces being placed farther from the centre, it will easily be understood that the torque is multiplied from five to seven times. The power of the brake at E E, E E is increased in the same proportion, so that the speed of the meter is not increased. One other point remains to be noticed, namely, that whereas in the former pattern there was an average error of from 20 to 30 per cent at full load, which was corrected by some 15 series turns, tending to raise the speed as the load increased, in the present pattern the error is only 5 per cent, and is corrected by about 3 series turns. The error being so very small, it is possible to apply the correction with great certainty, and a straight-line curve is readily obtained; the total result being that the meter is now, both for range and accuracy, far superior to earlier forms.

It has, in addition, the following advantages:—

Its mechanical construction is very strong, and its performance does not depend on delicate workmanship. The latter advantage is

due to the powerful permanent field, which, even at the bottom of the range, supplies ample driving force. It is an extremely simple instrument, possessing, as it does, apart from the counting train, but one moving part. The weight of this moving part is almost entirely carried by the mercury, with the result that the friction on the bearings is reduced to a minimum. Lastly, it consumes no current, the field being produced by *permanent* magnets, and costing nothing in energy. The advantage of this feature in practice is obvious.

The Hookham Direct-Current Electricity Meter

The latest pattern of this meter as now made, and as approved by the Board of Trade, is shown in fig. 285, with the door open to

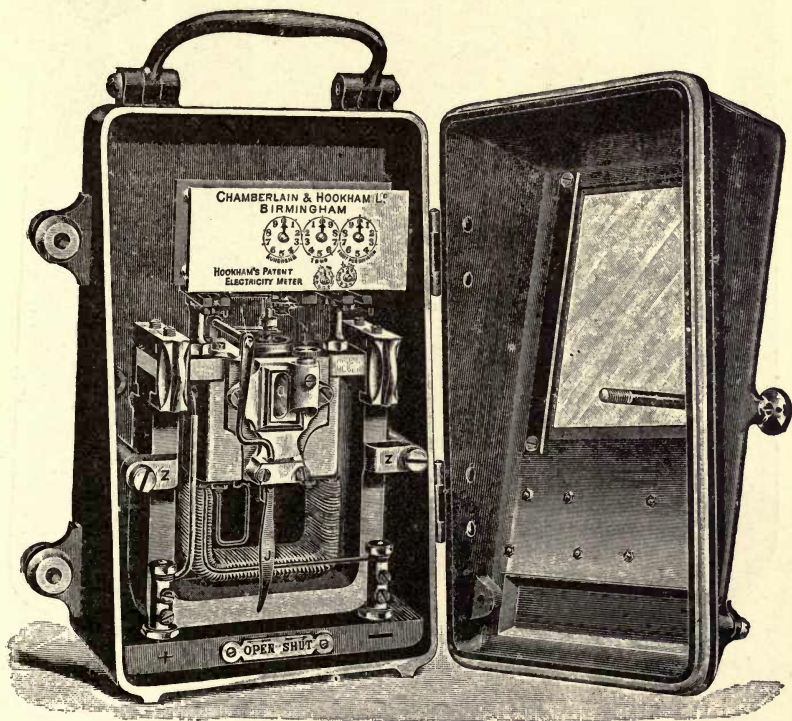

Fig. 285.—Hookham Direct-Current Latest Pattern Meter (interior)

show the internal arrangement, and in sectional elevation in fig. 286, from which the construction will be easily seen and understood. As it stands it is suitable for currents of $1\frac{1}{2}$ to 10 amperes.

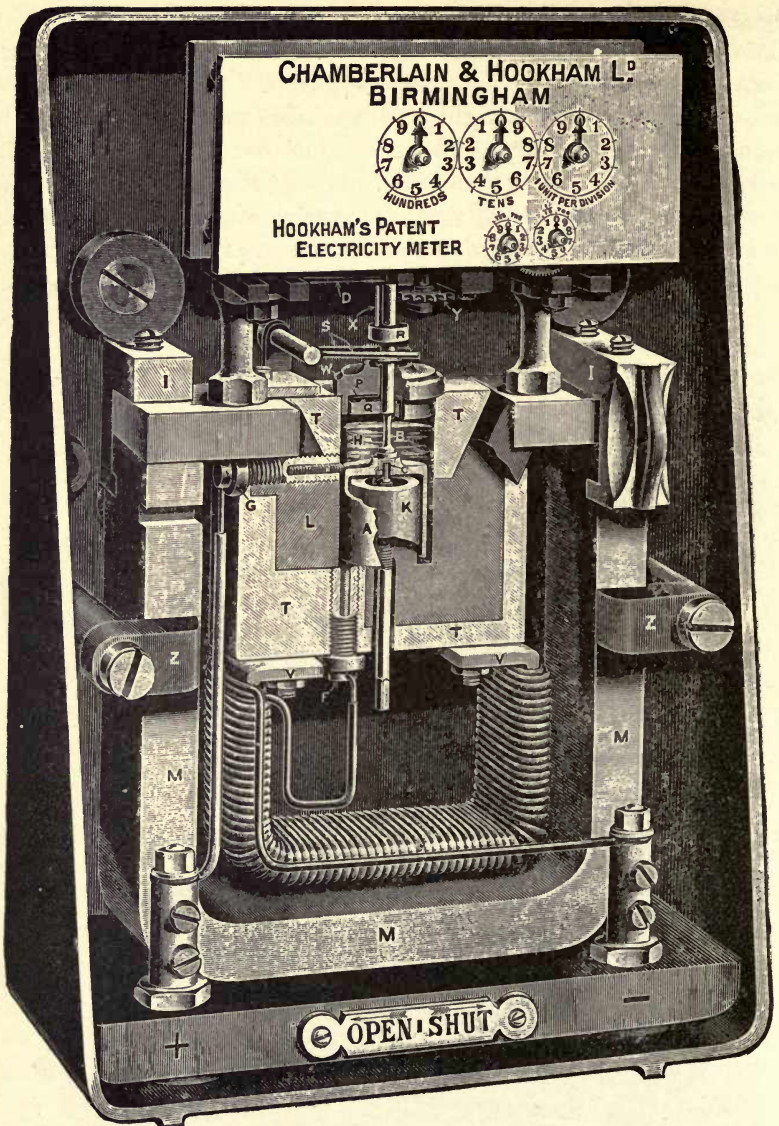

Fig. 286.—Hookham Direct-Current Latest Pattern Meter (section)

This meter consists of a cylindrical copper armature A, rotating upon a vertical spindle B, which is supported on a jewelled bearing C, and is held in position by a spring bearing D. The armature rotates in an annular chamber H, formed partly by the poles of

the meter partly sunk in the antimony block T. This chamber is filled with mercury to the height shown in the gauge-glass at the front. An intense magnetic field is produced between the pole-pieces K L by the permanent magnet M. The current to be metered enters the upper part of the chamber H by means of the conductor G, passes down the armature and leaves the chamber by the con-

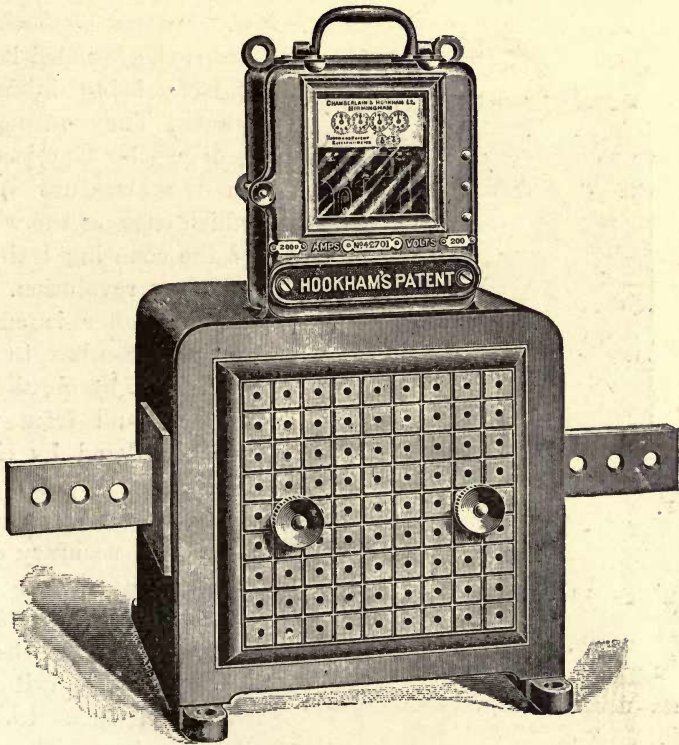

Fig. 287.—Hookham Direct-Current 150-Amp Meter mounted on Shunt Box

ductor F, causing the armature to rotate. The brake force of the meter is provided by the Foucault currents induced in the revolving armature by the same magnetic field which produces the driving force.

The armature, except at the amalgamated rings where the current enters and leaves it, is protected from action of the mercury by being plated with platinum.

The conductors F and G are connected to the terminals — and + respectively.

The armature chamber is covered at the top by a circular ebonite cover P. The armature spindle B carries two balance weights Q and R, so arranged as to ensure that there is no undue pressure on the steel pivot E, and that the armature practically floats in the mercury. By means of a lifting arrangement ss the armature spindle can be raised, and the chamber completely closed by the balance-weight Q pressing firmly against the rubber washer w. This arrangement also

keeps the jewelled bearing c from being injured in transit. The counting train is driven by a projection x on the armature spindle, which engages the wheel y of the counting train once in every revolution.

The meter is enclosed in a cast-iron box, to which it is fixed by ebonite buttons II, and from which it is insulated by ebonite blocks.

In order to increase the range and accuracy of the meter, the current to be measured passes round the coil wound upon the iron core v v; this coil being connected in series with the armature. The action



Fig. 288.—Hookham Direct-Current 5000-Amp Meter mounted on Shunt Box

of this coil is to weaken the field in which the armature rotates, and so reduce the brake force relatively to the driving force as the current and speed increase; it thus compensates for the slow error at high loads which would otherwise result from the fluid friction of the mercury. This object is attained, not by opposing or temporarily weakening the permanent magnet, but by diverting part of its field from the poles KL to the iron core v. Therefore no excessive current passing through the meter, as, for instance, from a short circuit, can possibly weaken the permanent magnet. This coil is omitted in the smallest sizes of meter.

When meters are required for large current circuits, up to, say, 5000 amperes, the special meter is fixed upon a cast-iron box containing terminals and shunts suitable for carrying the currents.

Fig. 287 illustrates a 150-ampere electricity meter mounted on its shunt-box, while fig. 288 illustrates the form of meters employed with currents of 2000 to 5000 amperes.

Ample cross-section and radiating surface is allowed with the shunt portion, the containing-box being perforated for this purpose.

Ferraris Electricity Supply Meter (For Single and Polyphase Alternating Currents)

These meters, supplied by Messrs. Siemens Bros. & Co., of London, are of the induction type, and will only work on alternating-current circuits. They have many important features which recommend them, amongst which should be noted their accuracy, simplicity of construction, and freedom from the effects of external magnetic fields. A sectional plan and elevational drawing of one is shown in fig. 289, from which the principle of action will be understood.

They consist of a simple motor on the Ferraris principle, combined with an eddy current brake, driving a counting train direct.

The moving part consists of a light pivoted aluminium drum *b*, surrounding a fixed iron core *c*, acted on by a rotating magnetic field produced by four poles, *e e f f*, surrounding the drum. Two opposite poles of these, *f f*, are energized by the currents to be measured, and the other two, *e e*, by a current derived from the volt current. This has a phase displacement of

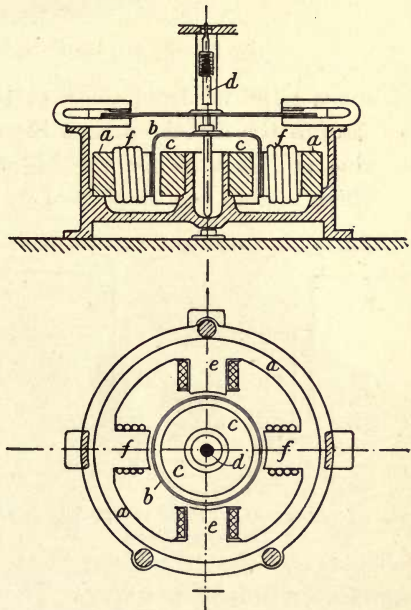

Fig. 289.—Ferraris Alternating-Current Meter
(plan and sectional elevation)

90 per cent from the main current, produced by a combination of inductances and resistances.

In the current circuit (except for quite low ranges) a transformer is used in the same way as with the ammeters, only small

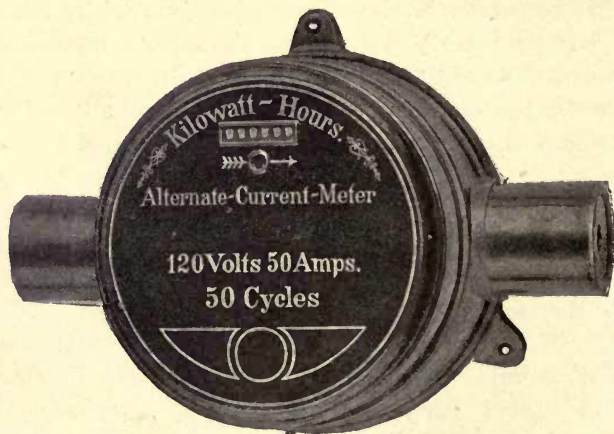

Fig. 290.—Ferraris Alternating-Current Meter (general view)

leads are required from these to the instrument, as in the case of the shunts for direct-current instruments. In the volt circuit a choking coil is used for the higher voltages.

These meters are unaffected by shock and vibration, and can be fixed to any wall.

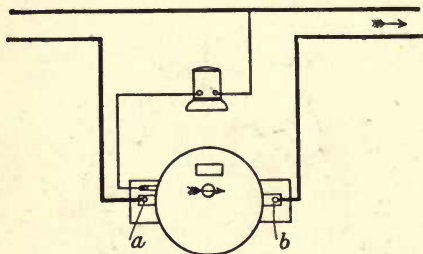

Fig. 291.—Connections of Meter with Choking Coil to Two-Wire Circuits

Special means are taken to eliminate friction so that the meter starts off at 0.25 per cent of its full current; also they will not run idly on open-lamp circuit, even if the voltage is 20 per cent above normal. Currents as low as 2 per cent of the full load are registered with an accuracy within 3 per cent. The smallest variation of voltage is instantly recorded, and an overload of 100 per cent will not spoil the meter. They are calibrated to read direct in kilowatt-hours without a constant.

Fig. 290 shows the general appearance of the meter ready for fixing in position.

Meters for currents above 300 amperes are provided with a separate current transformer, and for voltages at and over 550 volts with a separate choking coil, special connecting wires in the present case not being necessary.

Fig. 291 shows the connections of a meter with choking coil only, and fig. 292 of one with choking coil and current transformer, of which *AB* is the primary and *ab* the secondary side

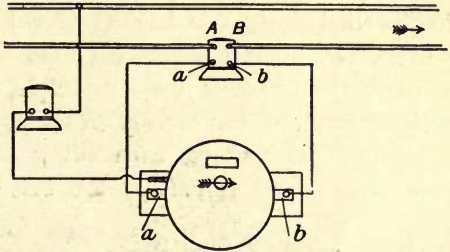

Fig. 292.—Connections of Meter with Choking Coil and Current Transformer

which is connected to the current terminals *ab* of the meter. For unbalanced polyphase circuits two meters are necessary.

Elihu Thomson's Electricity Meter

One of the most extensively used electricity meters at the present time is that devised by Prof. Elihu Thomson, and made by the British Thomson-Houston Co. of London. It belongs to the class of motor meters, and measures the *energy* given to a circuit in which it is placed.

The utility of the instrument may be gathered from its very wide use in America, and also in this country, the numbers in existence amounting to several hundred thousand.

The construction will be understood by a reference to fig. 293, which shows a part sectional front elevation of a Thomson meter.

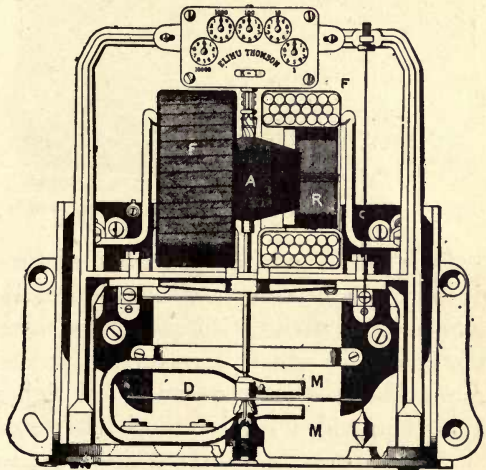

Fig. 293.—Principle of Construction of Thomson Meter (part section)

The ordinary standard form consists of a peculiarly-constructed

electro-motor, having no iron in either armature or field-magnets.

The armature A, which is mounted on a vertical spindle running in jewelled centres, is formed of a hollow frame of non-magnetic material. This is wound with a set of coils of fine insulated copper wire on the Siemens drum principle, and to the frame is attached a silver commutator, carried on the spindle near its upper bearing.

Two light springs, with silver contact pieces, bear upon this commutator and constitute the brushes, by which the potential current is led into and out of the moving armature A.

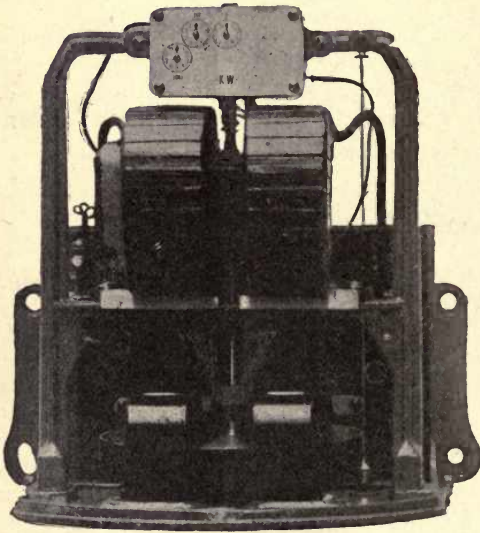

Fig. 294.—Interior of Thomson Meter for Medium Currents

This fine-wire armature is in series with a non-inductive high resistance R, carried in the frame at the back of the meter, and is connected across the mains, the combination constituting the voltmeter circuit of the meter. The current in this fine-wire circuit varies, of course, in direct proportion to the voltage at its extreme terminals, *i.e.* across the mains.

The field-magnets FF consist of two coils of thick copper conductor or wire, one on either side of the armature A. These are connected in series with each other, and with one of the mains of the circuit in which the expenditure of energy is to be measured. A plumb-line and bob, seen to the right-hand side of figs. 293 and 294, is provided for levelling the meter when being fixed.

Now, since the armature A and field-coils F contain no iron, the magnetic field due to each will be proportional to the currents flowing through them respectively. Therefore, since the fields due to A and F always maintain the same positions relatively to one another, the torque causing rotation of A, which is \propto to the product of the field strengths, is \propto to the product of the armature and field

currents. But the former is \propto to the voltage across the mains, and the latter is the main current.

\therefore driving torque is \propto volts \times amperes \propto watts at any instant.

Without, however, some retarding force or brake, other than that due to the small amount of friction caused by the moving parts, the speed of A would increase almost indefinitely, even though the driving torque remained constant.

Hence, to make the speed vary proportionally to the driving torque, *i.e.* to the watts, it will be necessary to introduce some resistance to the rotation of A, which shall increase in direct proportion to the speed, and this is done as follows:—On the lower end of the vertical spindle is fixed a thin copper disc D, which rotates in the constant magnetic fields between the poles of two or more permanent steel magnets M M.

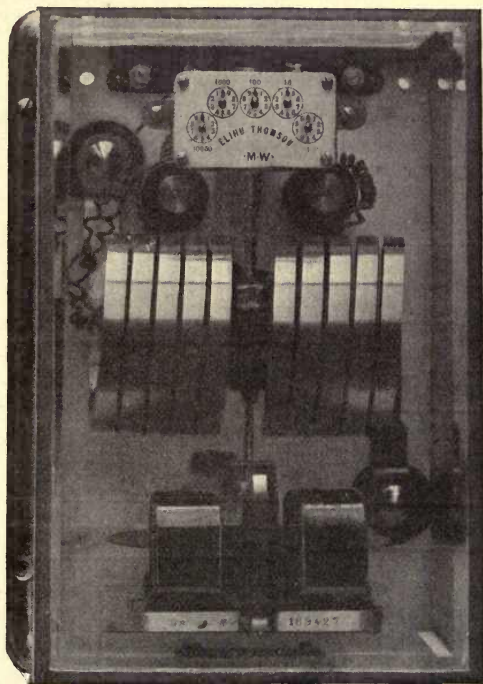

Fig. 295.—Interior of Thomson Meter for Heavy Currents

Foucault or eddy currents are thereby induced in the disc D, thus creating a drag on the moving armature A.

The ohmic resistance of the disc remaining constant, it is evident that in a constant field, such as that produced by the permanent magnets between the poles of which D rotates, the E.M.F., and consequently the induced currents in D, will be \propto speed. Thus we have:—

$$\begin{aligned} \text{Retarding force} &\propto \text{induced currents} \times \text{permanent field} \\ &\propto \text{speed.} \end{aligned}$$

Therefore when the meter runs at constant speed at any instant, the

$$\text{Driving torque} = \text{retarding force}$$

and hence the watts are \propto speed.

In this meter, consequently, the resultant speed is directly proportional to the watts; and if the armature spindle is geared to and drives a counting train, the dials of this train can be graduated directly in either Board of Trade units, watt hours, or kilowatt hours.

The meter will, of course, obey the same rules as an electro-motor or dynamo as regards the direction of rotation, and it will therefore

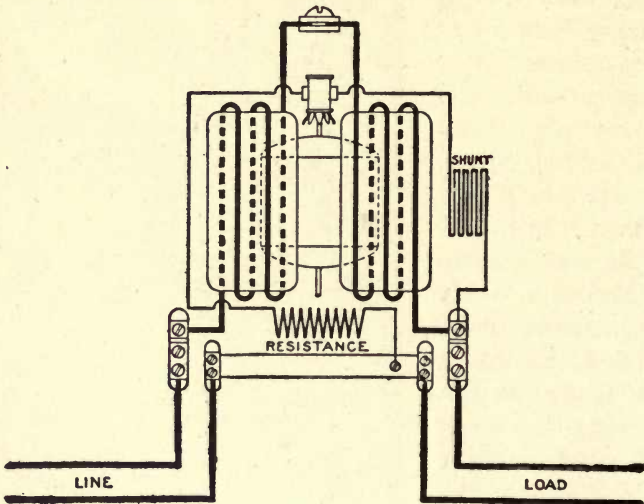

Fig. 206.—Connections of Thomson Meter to Two-Wire Circuits

be obvious that, if the currents through both armature and main-series coils are reversed simultaneously, the meter will go on recording as if nothing had happened, and the only way to reverse its direction of rotation is to interchange the terminals of either the armature or main-series coils.

From these considerations it will be at once evident that the meter will work with alternating currents just as well as with direct, and this is one of its most valuable properties.

As is the case with all motor meters, there is statical mechanical friction of the parts to be overcome at the start, and this must be compensated for in some way or another, in order to cause the meter to start at small currents. The compensation is generally effected by producing an initial field, constant in strength, and sufficient to overcome the mechanical friction at the small currents. In the case of the Thomson meter this is obtained by connecting

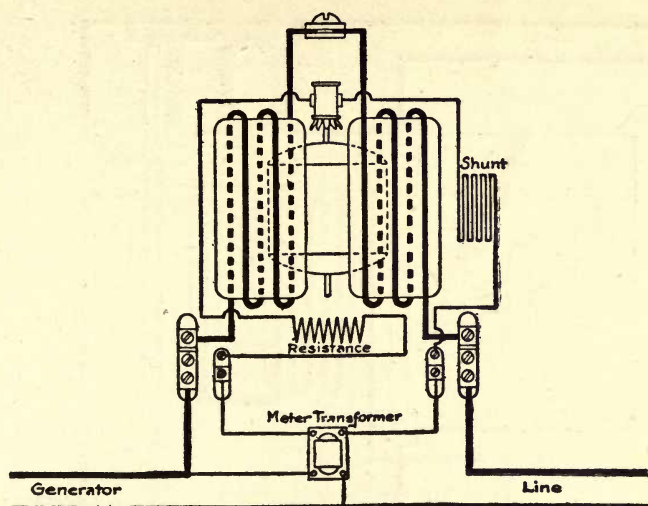

Fig. 297.—Connections of Thomson Meter to Single-Phase Alternating-Current Circuits

the pressure coil across the mains on the lamp side of the main-series coils.

In this way the constant current through the fine-wire circuit

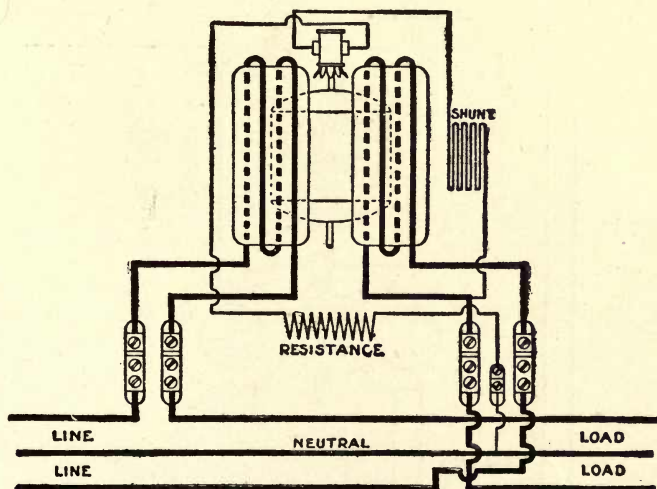

Fig. 298.—Connections of Thomson Meter to Three-Wire Circuits

passes also through the thick series coils, and produces a constant field sufficient to overcome the friction of the moving parts.

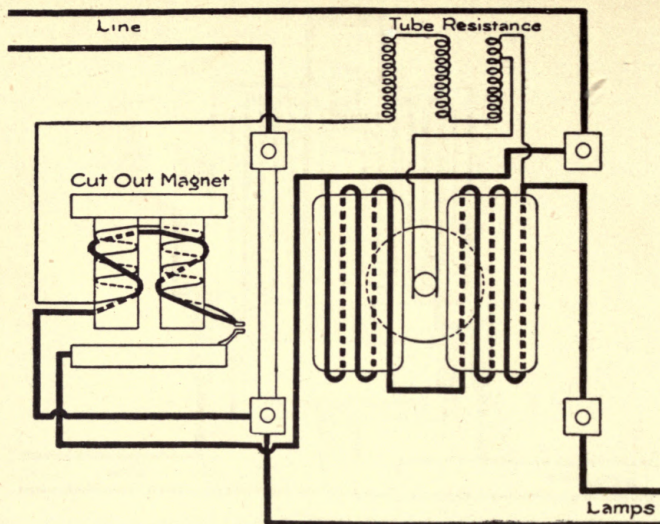

Fig. 299.—Connections of Thomson Meter to Arc-Lamp Circuits

It should, however, not cause the meter to actually start until the smallest candle-power lamp on the circuit is switched on, other-

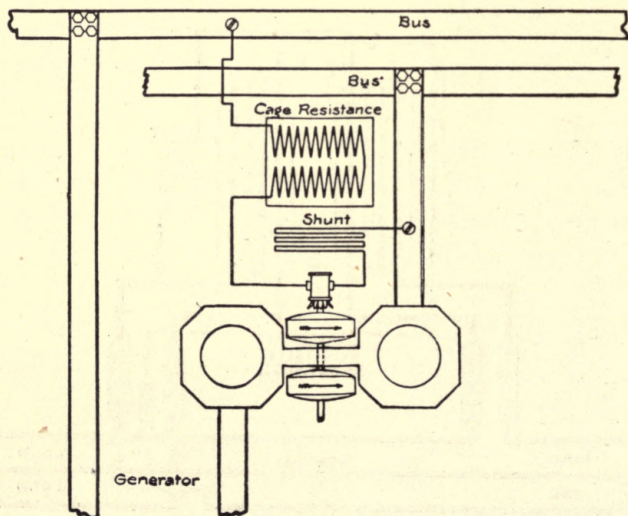

Fig. 300.—Connections of Thomson Meter for Heavy Outputs

wise the meter will record the energy wasted in the pressure circuit with no lamps on.

The meter, which starts with a small current unless out of order, absorbs but little energy for this class of meter. The starting current amounts to about 1 per cent of the maximum for which the meter is intended to register at.

The Thomson motor meter will record accurately the energy developed in any alternating-current circuit or any direct-current

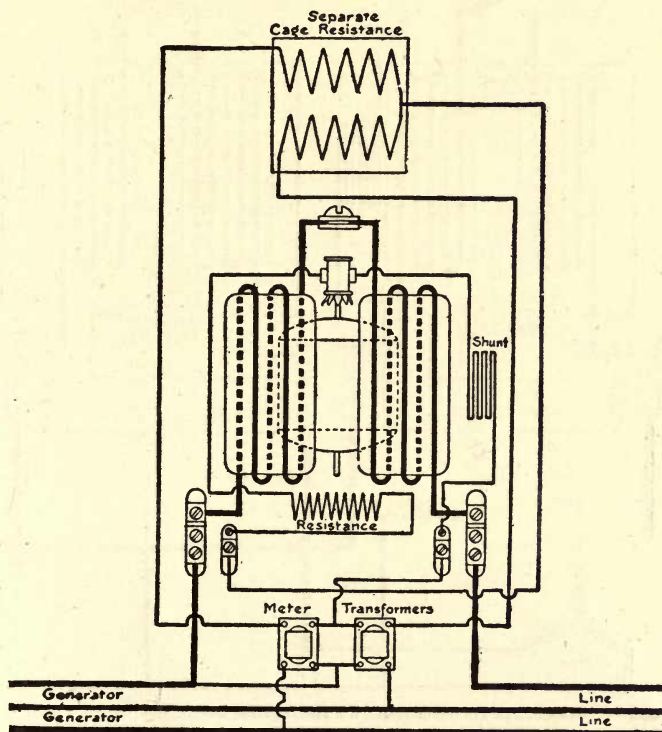

Fig. 301.—Connections of Thomson Meter for Three-Phase Balanced Circuits

circuit; and its indications are independent of changes in periodicity, power factor, wave form, or temperature. Its readings, which are direct in Board of Trade units, are proportional throughout the whole range.

Fig. 294 illustrates one of the meters intended for two-wire circuits with its cover removed to show the internal parts. Fig. 295, the same kind of meter, but for heavy currents and switch-board work.

As seen in the figure the main series coils each consist now of five turns of massive copper strip coiled up.

The connections of the meter, when used on low-pressure two-wire circuits, are shown in fig. 296, from which it will be seen that the armature in series with the shunt and non-inductive high resistance is connected across the mains on the lamp side of the series coils, to compensate for the friction, as mentioned on p. 274.

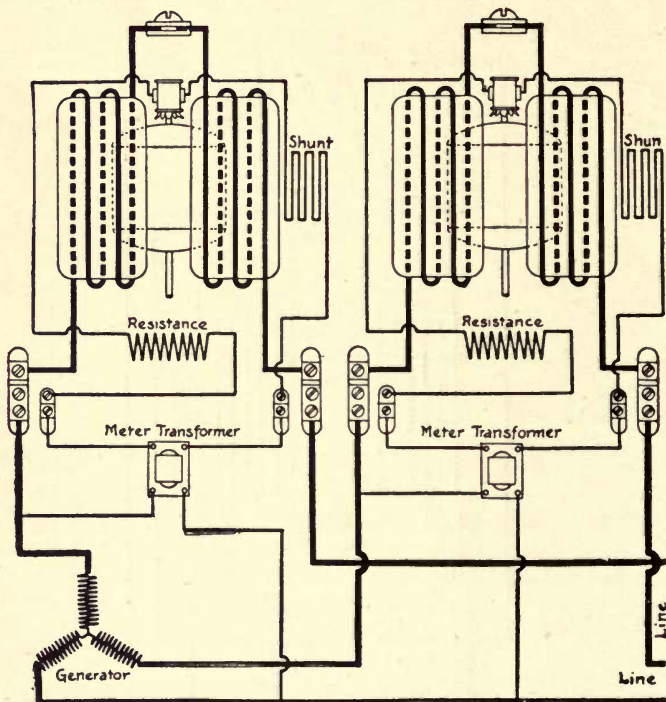

Fig. 302.—Connections of Thomson Meter for Three-Phase Unbalanced Circuits (two Meters)

When the meter is used on a primary or high-pressure circuit, it is usual to employ a transformer, which reduces the high potential of the mains down to about 100 volts on the secondary, and this supplies the fine-wire circuit of the meter.

Fig. 297 shows the connections of the arrangement by means of which a dangerous difference of potential between parts of the meter is avoided.

The transformer is one specially designed to ensure a correct reading of the meter. Fig. 298 indicates the connections of the meter to a three-wire circuit, from which it will be seen that a thick-wire coil is placed in series with each outer main, and the

fine-wire circuit across one of the sections, *i.e.* between the middle wire or neutral and one or other of the outers. The meter, therefore, records on the one set of dials the amount of energy supplied to the two sides of the three-wire system.

In the case of two-phase systems of alternating-current supply, two ordinary two-wire meters are used, one meter being connected in each phase. The sum of the readings of the two meters gives the total energy delivered to the circuit.

Figs. 299 and 300 show the connections for an arc-lamp circuit and for total output respectively.

For the measurement of energy delivered in a *balanced* three-phase system a modification of the ordinary meter is employed.

The current of one leg of the system (fig. 301) passes through the current coil of the meter, while the armature is connected to a set of three high resistances.

The meter shows the total energy delivered in a *balanced* three-phase system to which it is connected, and is equally applicable for either power or lighting circuits.

When the system is an unbalanced one, either two ordinary two-wire meters (fig. 302), or one single three-phase meter may be used, the latter being so designed and constructed as to read correctly on any kind of three-phase circuit, be it either balanced or otherwise.

The Vulcan Electricity Meter

This is an energy motor meter similar in principle and construction to the Thomson meter described on p. 271, and is therefore a special form of electro-motor having no iron in its construction. It measures the energy direct in Board of Trade units. The construction will be understood by a reference to fig. 303, which is a part sectional elevation of the meter, and also to the perspective view shown in fig. 304, which refers to the "B" type of this meter supplied by Messrs. Geipel & Lange of London.

The meter consists of two field-magnet coils A, wound with thick insulated copper conductor to carry the main current. These are fixed side by side, with an air-gap between them, their magnetic axes being collinear and horizontal.

In between these two main-series coils, and partly enclosed by them, is pivoted a fine-wire drum-wound armature B, mounted on a vertical spindle, which at its lower end rests and rotates on

a jewelled footstep or centre, let into a block κ . At the upper end is an ordinary fine loose-fitting bearing t' , merely for the purpose of preventing all side-play of the spindle. The bearing is carried at the top of a stout bracket.

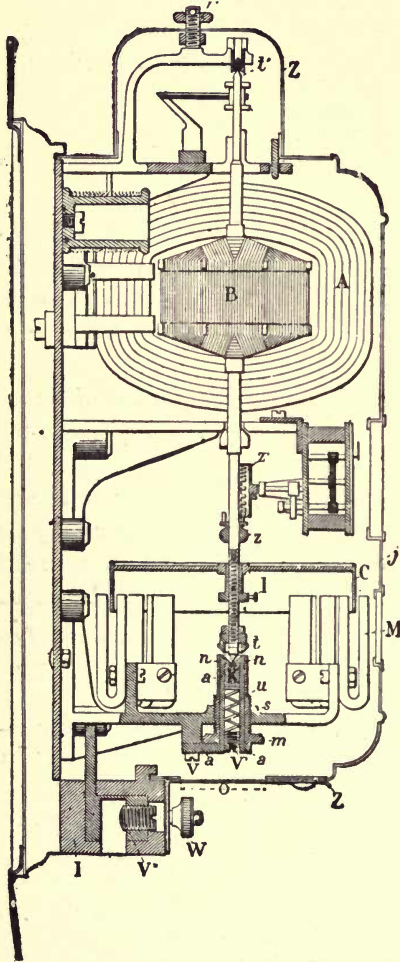

Fig. 303.—Principle of Vulcan Meter
(sectional elevation)

The fine-wire windings on the armature B are connected with a platinum commutator attached to the shaft, and seen in fig. 303 just under the upper bearing t' . Against this commutator, made of platinum so as not to oxidize or tarnish, press two light springs, which lead the pressure current into and out of the armature A .

A boss z , fixed to about the middle of the spindle, carries a worm-screw thread, which gears into a worm-wheel z' , driving the train of recording wheels and dials on the right of fig. 303. The lower part of the vertical spindle below z is screwed to receive the boss carrying a light copper cylinder or cup c . The sides of this cup rotate between the poles of a crown of horse-shoe-shaped permanent magnets M , shown numbered and more clearly in fig. 304. The cup c can be prevented from turning on the spindle by a clamping set-screw I in the boss.

The block κ , in which is fixed the lower jewelled footstep, rests on a spring n in a tube a , and is capable of sliding in a . A set-screw v' closes the lower end of this tube, and the spring rests on it. By screwing up the screwed boss n by means of its milled head or locking nut m , the whole of the jewel carrier

with armature is raised and clamped in three places to avoid damage in transit.

The tubular portion *a* is fixed by a set-screw *v* to the main bracket *s*, which also supports *m*.

Four terminals are provided at the bottom, consisting of the screw with its milled head *w* working in a brass block *v''* encased in insulating material *i*.

The working parts of the meter are enclosed in a dust- and moisture-proof case *J*, provided with a window opposite the dials of the recording train, and one opposite the poles *M* and cylinder *C*, for viewing this latter as it rotates.

A detachable hood *z*, arranged to facilitate the inspection of the commutator without removing the main case *J*, is clamped by the nut *w*¹.

A sealing cover *o* is provided, which is finally sealed by the supply company after the moving system has been freed by the locking nut *m*.

The action of the meter is precisely similar to that of the Thomson meter (*vide* p. 273). Hence the speed of the revolving armature is directly \propto to the total energy absorbed in the circuit in which the meter is placed.

A compounding coil of fine wire is inserted to compensate for the friction of the moving parts by producing an initial magnetic field at the field-magnets independent of the main current.

Thus, only a very small main current, amounting to from $\frac{1}{150}$ to $\frac{1}{200}$ of the full-load current, is required to give the necessary extra torque for starting the meter registering.

The fine-wire wound armature is in series with the compounding coil, and a large non-inductive resistance, wound on an insulating tube, seen covering the left-hand top corner of the main coils *A* in fig. 303. The connections of the series coils and armature with the two- and three-wire systems of supply is shown in figs. 305 and 306, in which *abcd* are the four main terminals of the meter.

As will be observed, the chief difference between them is,

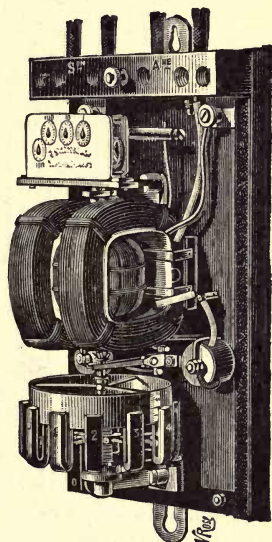

Fig. 304.—General View of Vulcan Meter

that both series coils are in series with one another across a and d , and are also connected in series with one main in two-wire meters. But in the three-wire form, one coil is connected to a and b , the other to c and d ; they are then connected in series with the two outer mains, as shown in fig. 306, the armature circuit being across one section.

Matters are so arranged that all Vulcan meters run at 60 revolutions per minute at full load. Hence, if N are the number

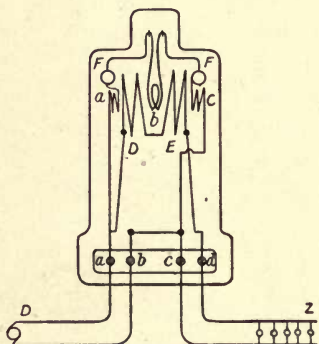

Fig. 305.—Connections of Vulcan Meter to Two-Wire Circuits

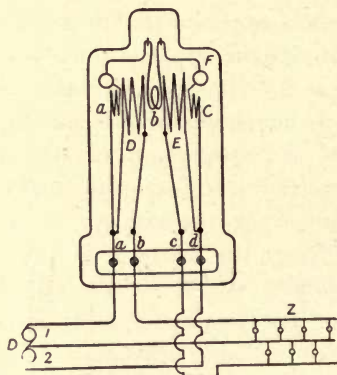

Fig. 306.—Connections of Vulcan Meter to Three-Wire Circuits

of revolutions of the armature, counted in T seconds, by watching the damping cylinder as it rotates with B , and P is the full load of the meter in watts,

$$\therefore \text{watts registered by meter, } w = P \cdot \frac{N}{T}.$$

If the armature revolves too fast or too slow as found from this relation, the speed is adjusted by varying the retarding effect of the Foucault brake as follows:—

Unscrew I on the boss of the brake cylinder frame, then screw the cylinder *up* the shaft to *increase*, and *down* to *decrease*, the speed. When finally adjusted correctly, tighten up I again. This type of meter, as already mentioned, will register correctly on either direct or alternating-current circuits at will.

The watt consumption of a 100-volt meter at light load is 2 watts per hour, and at full load 2.025 watts.

The limits of error at one-fifth load up to full load are less than 0.5 per cent, 1.5 per cent, and 2 per cent, in meters intended for 500 watts, 10,000 watts, and 30,000, watts respectively.

The starting energy of a 200-ampere 100-volt meter, is between 30 and 40 watts.

The following results were obtained in an exhaustive series of tests made with a vulcan meter for 100 amperes and at 100 volts. Thus, at—

	Full load it read correctly.			
$\frac{1}{3}$	"	"	"	0.2 per cent slow.
$\frac{1}{10}$	"	"	"	0.2 " " "
$\frac{1}{70}$	"	"	"	11.9 " " "

The accuracy, with varying voltage, was as follows:—

Voltage,	16 per cent too high;	error,	0.3 per cent fast.
"	normal	"	nil.
"	15.5 per cent too low;	"	0.2 per cent slow.

The difference in the readings of the meter when running with alternating current at periodicities varying from 50 to 120~ per second was found to be less than 0.1 per cent, and it was equally correct with direct currents.

The effect of varying power factor on its accuracy was as follows:—

Apparent Watts.	True Watts.	Power Factor, per cent.	Error, per cent.
500	500	100	0 slow.
500	500	90	0.2 "
625	500	80	0.3 "
715	500	70	0.5 "
835	500	60	0.8 "
1000	500	50	1.2 "
1250	500	40	2.0 "

The fall of potential in the main-current coils at full load (100 amperes) = 0.063 volt, and the current in the fine-wire circuit at 55° F. was 0.0239 ampere at 100 volts.

The temperature error was 0.1018 per cent per 1° C. at temperatures varying from 37.8° C.

The Vulcan Prepayment Electricity Meter.

This is an adaptation of the ordinary Vulcan watt-hour meter just described. It consists of two parts: (1) the electricity meter proper, which is precisely similar in construction and action to that

above mentioned; (2) the mechanical prepayment portion. A general view of it is shown in fig. 307.

The operation of the meter is as follows:—A penny is put into the slot provided and a key turned. This winds up a spring a certain amount, and at the same time switches on the current. If there is a load on, the meter armature at once starts revolving,

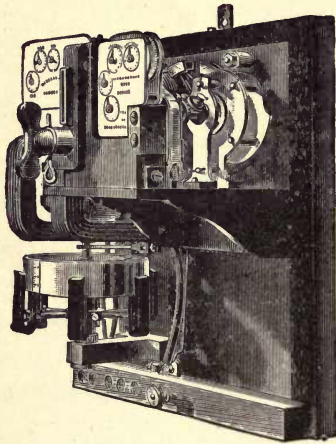

Fig. 307.—Vulcan Prepayment Meter

and being connected by means of a delicate escapement to the mechanical portion of the meter, it gradually releases the spring, and after a certain number of revolutions have been made allows the switch to open circuit.

If two pennies in succession are put into the meter, then the amount of energy which can pass through the instrument before the circuit is opened is doubled, and so on with the succeeding coins. As many as eight coins can be put in at one time. A lock is fitted so that no more than this number of coins can

be inserted, and there is therefore no possibility of the meter being overwound.

The total number of coins received is registered, and also the number still unused. A till is provided that holds 120 of them, and has a separate sealing from that of the main meter case.

The Schallenberger Electricity Meter

It has already been pointed out that the great trouble in the generality of motor meters is the friction of the moving parts, which, if not minimized and compensated for, causes irregularities in the direct proportion between speed and the thing measured. Consequently it is an advantage that there should be no rubbing contacts in the meter, other than, of course, in the bearings, which can be minimized, but not entirely eliminated.

A meter made by the British Westinghouse Electric Manufacturing Co. that fulfils the above requirements in a highly satisfactory degree is that introduced by Mr. Schallenberger some

years ago, and which may be said to be one of the most satisfactory coulomb-motor meters in existence at the present day.

It is solely for use with alternating currents, and will not work with direct currents.

The principle on which it works is very similar to that of a two-phase alternating-current induction motor, and its construction is such that there are no rubbing contacts, and no electrical connection whatever to the moving system.

The construction will be understood from a reference to fig. 308, which shows a 60-ampere Schallenberger meter with cover removed.

It consists of two rectangular flat-shaped coils *M*, fixed side by side with a narrow gap between them, and their magnetic axes collinear and horizontal. They are wound with thick copper wire, and connected in series with one another across the two terminals of the meter, and carry the entire main single-phase alternating current to be registered. Inside these two primary main coils is fixed a similarly-shaped *closed coil*

c of insulated copper wire in two halves, and which may be termed the secondary, set with its magnetic axis horizontal, and at an angle (in some cases of 45°) to that of the main coil *M*.

Capable of rotating inside this closed secondary coil *c* is a thin light metallic disc *D*, mounted on a vertical spindle running in jewelled centres.

The upper end of this spindle is geared to a train of recording toothed wheels and pinions with dials, through a worm and worm-wheel, while the lower end carries a set of four aluminium fan blades *A*.

Thus, with the exception of a light train of gears, constituting the recording device of the meter, the only friction in the instrument is that between the lower pointed end of the vertical steel

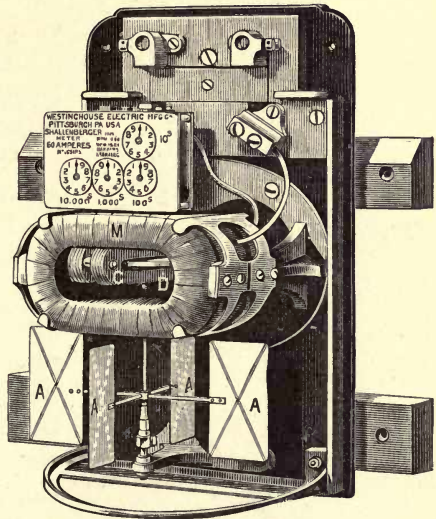

Fig. 308.—Interior of Schallenberger Meter

spindle, which is carefully hardened and polished, and the jewelled bearing upon which this rests and turns.

The spindle, of course, passes up through the narrow gap separating the halves of the main primary and closed secondary coils. These sets of coils can be adjusted to any angle between their magnetic axes, so as to vary the calibration of the different sizes of meters.

The action of the meter is as follows:—

When an alternating current flows through the primary coil *M*, an alternating magnetic field is developed in its axis.

At the same time an alternating current is induced in the secondary closed copper coil *C* in the direction of its axis, thereby producing an alternating magnetic field at an angle to the main field. These two fields, however, differ in phase, *i.e.* one attains its maximum strength before the other; consequently the direction of the maximum effect of the resultant field produced by these two component fields is constantly shifting or moving in a circle, giving what is usually termed a rotatory magnetic field.

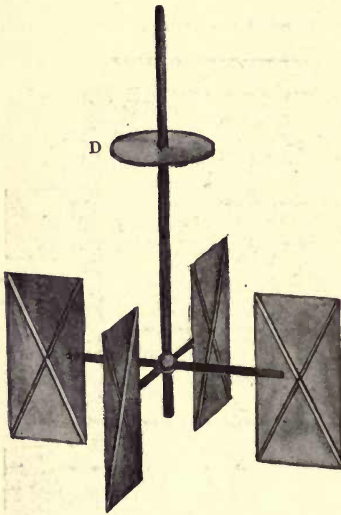

Fig. 309.—Moving System of Schallenberger Meter

But the iron disc *D* has definite polarity induced in it due to this resultant field, which causes it to start rotating and to catch up and revolve in synchronism with the rotatory field. The driving torque is approximately proportional to the square of the current in the coils *M*; and the retarding force, which is produced by the friction between the fan blades *A*, as they rotate with the spindle, and the air, is proportional to the square of the speed. Hence, when the driving and retarding forces balance, the speed will vary directly as the current in the primary coil *M*.

The number of revolutions of the disc *D*, which is therefore proportional to the quantity, in ampere hours, which has passed is recorded by the train of wheels on the dials of the meter.

The entire revolving system is shown in fig. 309, the disc *D* being seen above the four fan blades on the vertical spindle.

The general outside appearance of the meter is shown in fig. 310, enclosed in a dust- and moisture-proof metal cover. The meter is practically correct within eight periods per second above or below that for which it is adjusted, but it is always calibrated for the periodicity at which it has to work.

While a temporary overload of 50 per cent will do no damage to the meter, it will not read correctly for currents greater than its rated capacity.

To tell the exact current flowing at any time.—Note the number of revolutions made by the small "tell-tale" index on the top of the movement, in a number of seconds equal to the constant of the meter. The number of revolutions noted will correspond to the number of amperes passing through the meter. For example: the 20-ampere meter constant is 63·3; if the index makes ten revolutions in 63·3 seconds, 10 amperes are passing through the meter. In order to avoid errors in reading, it is customary to take the number of revolutions in a longer time, say 120 seconds; then, as a formula, we have:

$$\frac{\text{Number of revolutions} \times \text{meter constant}}{\text{Number of seconds}} = \text{current.}$$

If, therefore, the index of a 20-ampere meter makes 19 revolutions in 120 seconds, the current passing is

$$\frac{19 \times 63\cdot3}{120} = 10 \text{ amperes.}$$

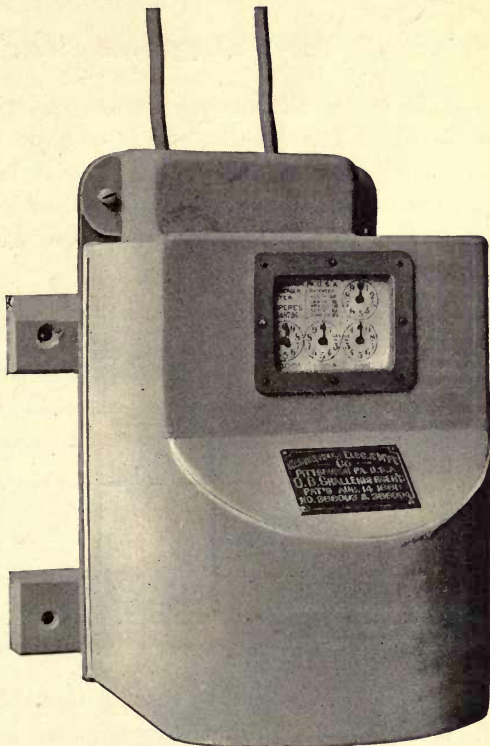

Fig. 310.—Outside View of Schallenberger Meter

One important advantage in this kind of meter is that there are no rubbing contacts, and therefore very little friction. The direct result of this is, that they consume very little energy.

The Westinghouse Electricity Meter

This is an alternating-current energy meter, recording direct in Board of Trade units, and is of quite modern origin and recent invention, being made by the British Westinghouse Electric and Manufacturing Co., London. The meter is practically a form of alternating-current induction motor, in which the primary circuit is

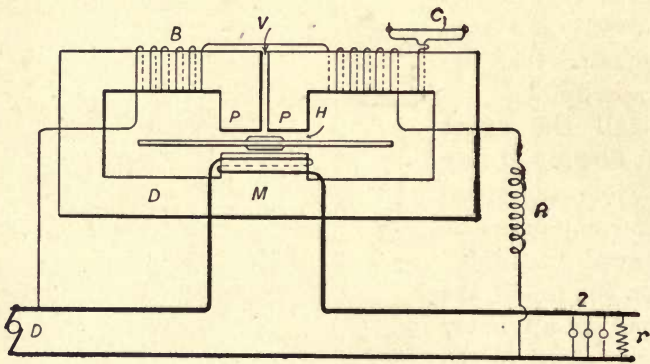

Fig. 311.—Principle of Westinghouse Meter

fixed while the secondary rotates at a rate directly proportional to the true power of the primary circuit.

Its construction is extremely simple, and it combines the accuracy of a delicate electrical laboratory instrument with a strong and portable mechanical structure.

The construction of this Westinghouse Integrating Wattmeter, as it is commonly termed, will be understood from a reference to fig. 311, which shows diagrammatically the principles and connections. The primary consists of an electro-magnet of the shape shown, comprising practically two horse-shoe magnets, the two lower poles of which are combined to form one pole, while the two upper poles remain separated by the narrow vertical gap v . Into the horizontal gap H , between the lower pole and the two upper ones, projects a small light disc, which forms the secondary and moving part of the meter.

This disc is carried on a short vertical spindle running in

jewelled centres, the upper end of it being geared to a train of recording wheels and dials, through a worm and worm-wheel. Thus there are no rotating coils or wires and no rubbing contacts, in fact no electrical connection whatever to the moving system. The windings of the primary consist of a series coil, shunt coil, and compensation coils, the series coil being wound on the lower combined pole. The shunt is divided into two halves, one being wound on each of the upper poles, and they are connected together so as to magnetize the core as a continuous ring, the magnetic field passing across the gap *v*. The small short circuit coil *c* is to compensate for running friction. The rotation of the disc is retarded by a permanent magnet which induces Foucault or eddy currents in it in the usual way.

The magnet is carried on slides, by which its position with respect to the disc can be adjusted.

The series coil consists of a few turns of thick insulated copper wire connected directly in series with one of the mains of the circuit.

The shunt coil is in series with an *inductive* resistance, consisting of a fine-wire coil wound on an iron core fixed in the base of the meter, the object being to secure a phase difference between the shunt and series currents of the meter, so that a rotatory field may be obtained to rotate the secondary.

As is well known, the phase difference should, if possible, be 90° , and the shunt circuit is so adjusted to give this as nearly as possible when the external circuit consists of an ordinary incandescent lamp load or other practically non-inductive load.

The series and shunt currents differing from each other by nearly 90° , the effect is to produce a shifting magnetic field of varying intensity across the horizontal gap *H*. Taking the effect over a complete period, with the series current at zero, the shunt current is a maximum and the core is magnetized as a simple ring, the magnetic field passing across the small vertical gap *v*, whilst there is no flow, or only a very slight leakage, across the gap *H*. As the series current rises in strength and the shunt current diminishes, a field is produced between the lower pole-piece and one of the upper pole-pieces; the magnetic field is thus restricted to one side of the gap *H*. This field rises in intensity to reach a maximum when the series and shunt currents are both positive and equal in value. From this point the shunt current

decreases to zero and the series current reaches its maximum positive value, when the flux becomes even between the lower pole and both the others, there being a uniform field across gap H and no flow across gap V.

As the series current decreases from its maximum positive value,

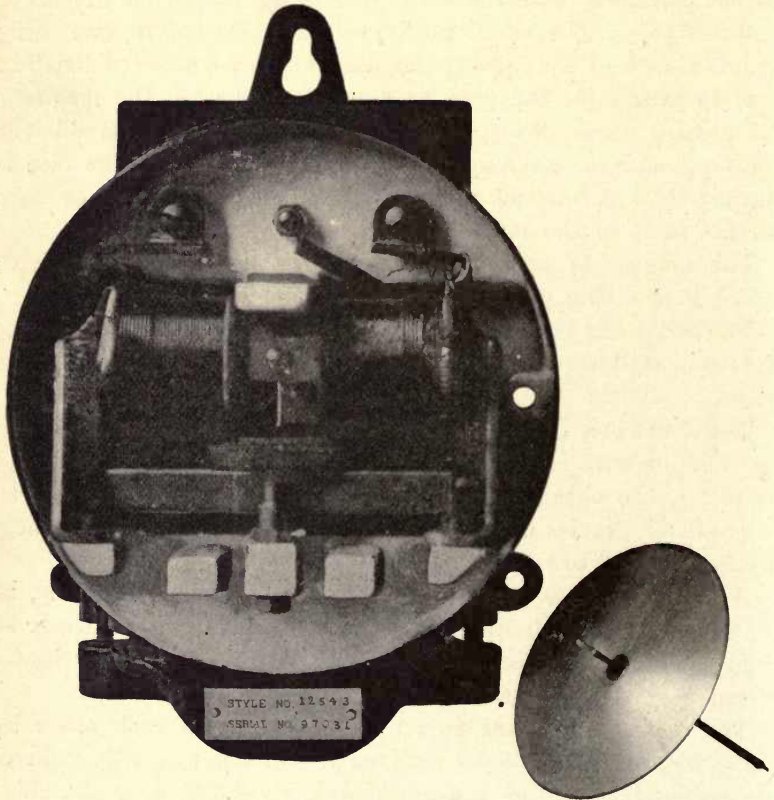

Fig. 312.—Interior of Westinghouse Meter (Counting Train, Damping Magnet, and Moving Disc detached)

the shunt current is rising from zero to a negative value, and the flux gradually shifts along gap H until, when the series and shunt currents are equal and opposite in value, the flux is concentrated between the lower pole and the other upper one.

From this point the shunt rises to its maximum negative value as the series current dies down to zero, and hence there is no flux through H, but the core is again magnetized as a simple ring by the shunt coil, the total flux passing across V.

This cycle is repeated through the other half of the period, the only alteration being the change in the direction of the magnetic field, and the whole action is continuous and periodic. It will therefore be seen that the field across gap H changes from zero to a gradually increasing flux at one side between the lower pole and one of the upper poles, then spreads evenly over the gap,

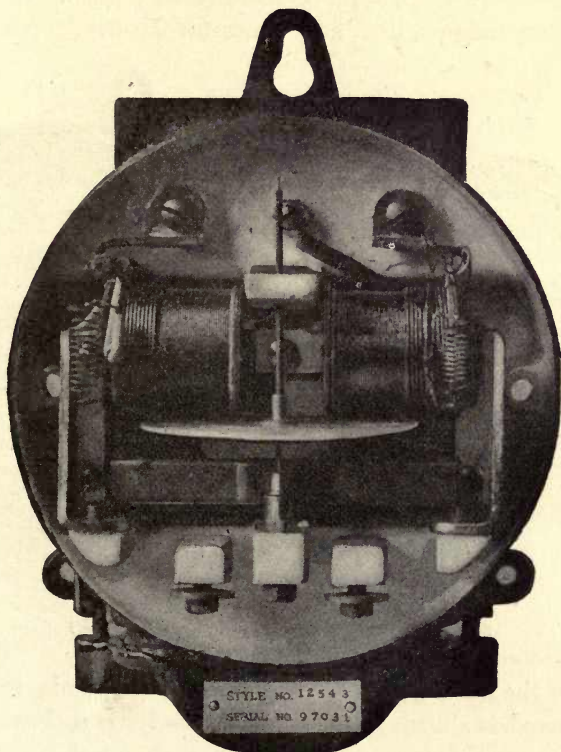

Fig. 313.—Interior of Westinghouse Meter (Moving Disc in position)

and afterwards concentrating between the lower pole and the other upper pole.

The field shifting repeatedly from one side of the gap to the other causes the disc to rotate, operating on the well-known principle of the induction motor.

This meter measures the true energy given to the circuit in which it is placed, under all conditions of inductive and non-inductive load, and the same principle is easily adaptable for poly-phase meters, which are made for two- and three-phase circuits.

These also record the true energy given to the circuits under all conditions of power factor, and whether the phases are balanced or not.

This feature is particularly important, and is one of the most noteworthy improvements in meter practice exhibited by the Westinghouse meter.

Fig. 312 shows a single-phase meter with counting train, permanent damping magnet, disc, and cover all removed; and the same

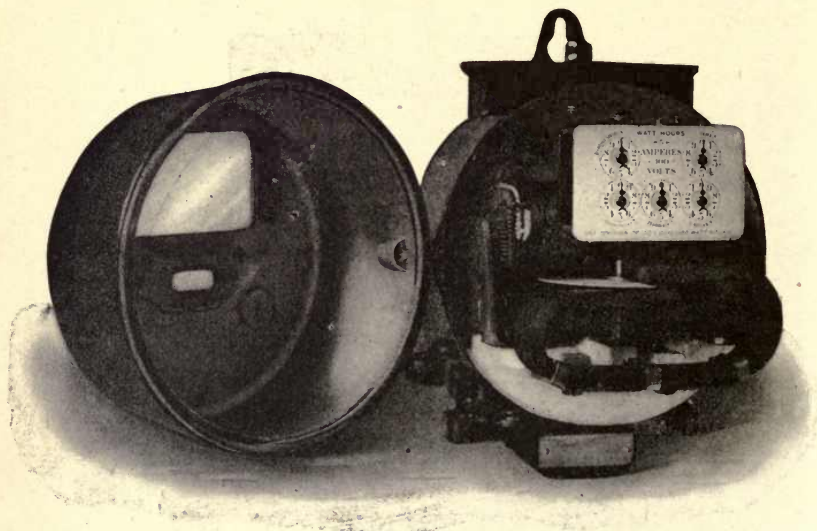

Fig. 314.—Interior of Westinghouse Meter (complete)

meter with the disc in position, but the counting train, magnet, and cover removed, is shown in fig. 313. The meter is enclosed in a dust- and moisture-proof case, sealed by the *makers*, who can therefore guarantee its operation. Further, the moving parts, being very light, are not clamped in transit, and the terminals are in a separate small enclosed chamber at the top of the meter. This is closed by a lid, which can be sealed by the supply company.

These Westinghouse energy meters commence recording with a load of $\frac{1}{2}$ of 1 per cent of their rated full-load capacity, and read accurately over the entire range. They have an overload capacity of 50 per cent above the rated capacity, and read accurately up to this degree of overload.

In all sizes, the moving disc rotates at 50 revolutions per minute

when running at their *rated full load*. At other loads the speed is \propto to the load up to the 50 per cent overload, when the disc will run at 75 revolutions per minute. The record of the meter can thus be checked with a fair degree of accuracy without elaborate calibration.

One very important feature of this meter is the small loss in it. In those for 100 to 200 volt circuits the loss in the shunt coil does



Fig. 315.—General View of Westinghouse Meter

not exceed from 1.25 to 1.5 watts; that in the series coil of a 5-ampere meter at full load does not exceed 0.5 watt.

The makers guarantee that the total full load loss in a 5-ampere single-phase meter shall not exceed from $2\frac{1}{2}$ to 3 watts.

Figs. 314 and 315 show the meter complete, with cover removed and cover on respectively.

The Electrical Co.'s Alternating-Current Electricity Meter

This is essentially an energy motor meter for alternating currents only, reading direct in Board of Trade units. It is applicable to either two- or three-wire circuits, but will not work with direct currents.

It is really an alternating-current induction motor, working on the rotatory-magnetic-field principle, and has the advantage of simplicity and lightness of armature, absence of brushes or rubbing contacts, and the possibility of using iron in its construction, thus obtaining larger power with less weight.

In the motor meter manufactured by

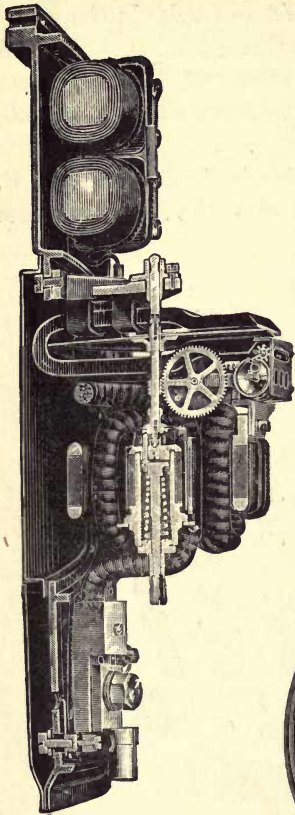

Fig. 316.—Electrical Company's Alternating-Current Meter (interior sectional view)

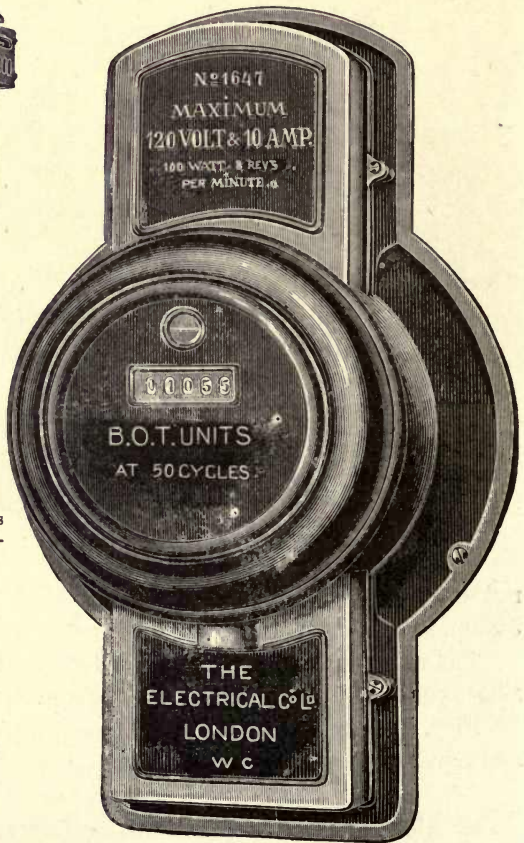

Fig. 317.—Electrical Company's Alternating-Current Meter (exterior)

the Electrical Co. a special form of construction has been devised, taking every advantage of the properties of the single-phase alternating current.

Figs. 316 and 317 show internal and external views of it.

The motor is constructed on the principle of Ferraris, and the armature is of the short-circuited squirrel-cage type, consist-

ing of a single winding in the shape of a bell, and is made of copper.

To produce as light a moving system as possible, and further to reduce the bearing friction to a minimum, the iron armature is stationary and only the copper bell rotates.

In this way the whole weight of the revolving system, bell, spindle, and brake disc, is reduced to 60 grains. The disposition of the rotating mass is such that, through the Thomson effect, the

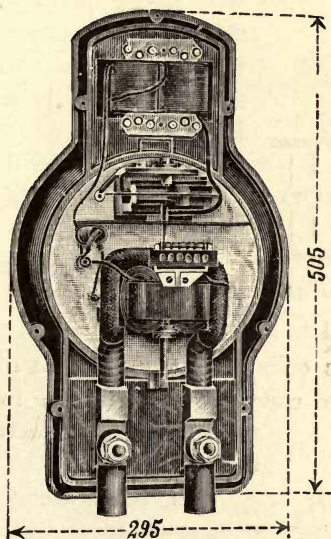

Fig. 318.—Interior of Electrical Company's Alternating-Current Meter for Two-Wire Circuits

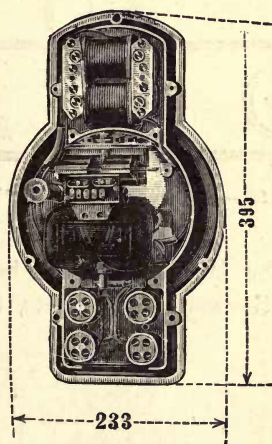

Fig. 319.—Interior of Electrical Company's Alternating-Current Meter for Three-Wire Circuits

weight is partially counterbalanced and taken off the jewelled bearing, the effective weight on the latter being less than 60 grains.

By means of a simple device of attaching a light piece of iron wire to the aluminium brake disc, it is impossible for the meter to run on the shunt, *i.e.* on open circuit, the iron wire being attracted by the permanent magnets.

An exact quarter-phase difference between the main and shunt currents can be obtained by means of the patent non-inductive parallel resistance to the shunt, so that the meters register quite as accurately with inductive loads as with non-inductive loads.

The revolutions of the spindle are conveyed through worm gear to a counting mechanism, and thus continuously integrated.

The revolutions can be very easily counted, as a white mark is painted on the periphery of the aluminium brake disc and can be readily seen through a window in the cover provided for that purpose.

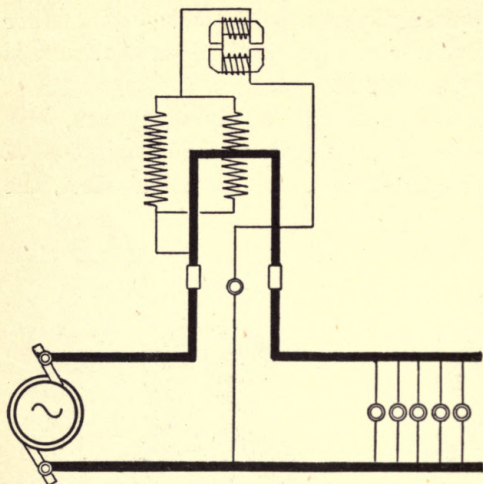

Fig. 320.—Connections of Two-Wire Alternating-Current Meter

in the latter there are two series coils of smaller wire suitable for the smaller currents, these two coils being connected in the

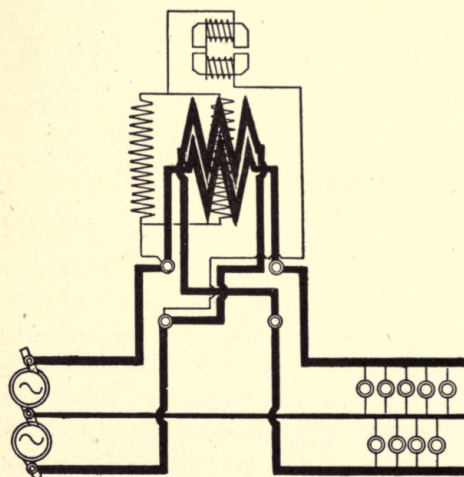

Fig. 321.—Connections of Three-Wire Alternating-Current Meter

two outer mains of a three-wire system. The only difference being that in the former not quite one complete turn of massive copper conductor is used for the series coil, while

for the smaller currents, these two coils being connected in the

two outer mains of a three-wire system. The connections and coils are diagrammatically represented in figs. 320 and 321 respectively for these two types of meter shown in figs. 318 and 319.

These meters read accurately to within 2 to 3 per cent from 4 per cent of full load up to full load. Fig. 322 shows the error curve of one of these alternating-current induction motor meters. From

this it will be observed that the maximum error occurs at $\frac{1}{10}$ full load, and amounts to about 2 per cent. Below this, down to $\frac{1}{25}$,

and above it, up to $\frac{1}{3}$ full load, the error diminishes and gets less and less, becoming zero at both these limits. Above 30 per cent full load the error gradually increases, and reaches at $\frac{3}{4}$ full load a maximum of nearly 2 per cent.

This class of meter is independent of variations in voltage amounting to 20 per cent above or below the normal value. This is shown in fig. 323, which is a curve relating voltage and error at constant frequency.

Fluctuations of periodicity, such as are ordinarily met with in practice either with inductive or non-inductive loads, have no influence on the accuracy of the meter.

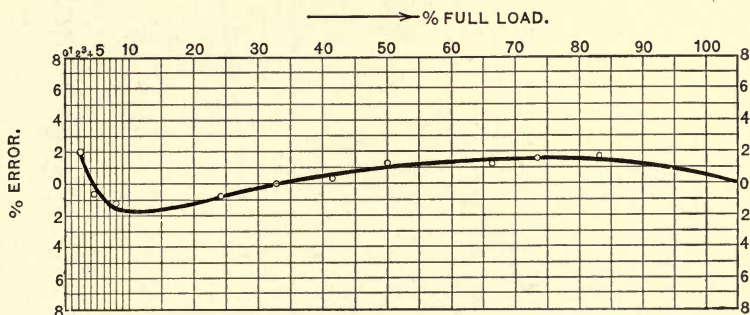

Fig. 322.—Error Load Curve of Alternating-Current Meter

Large fluctuations have, however, and the variation is shown in the curve, fig. 324, which connects error and periodicity at constant voltage with inductive loads.

These meters take full account of phase differences between current and voltage in the circuit, and are calibrated on inductive loads having the usual power factor of 0.75 commonly met with in practice.

They are designed to stand with impunity a temporary overload of six times the normal current, *e.g.* when motors, &c., are switched into circuit.

The losses occurring in the main-series and shunt coils are very small for motor meters. The shunt loss is constant, and is 1.5 watts per 100 volts for any meter; the loss in the series coils at full load never exceeds a maximum of 1.5 watts.

The meters do not register on open lamp circuit, *i.e.* on the shunt current only, even with 20 per cent increase in volts, but all types and sizes start with 1 per cent of their maximum rated capacity.

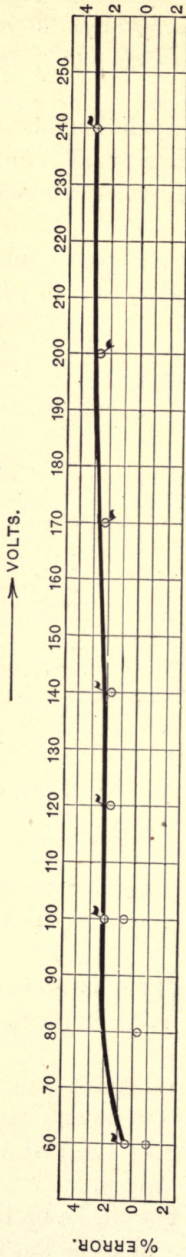

Fig. 323.—Error Voltage Curve of Alternating-Current Meter

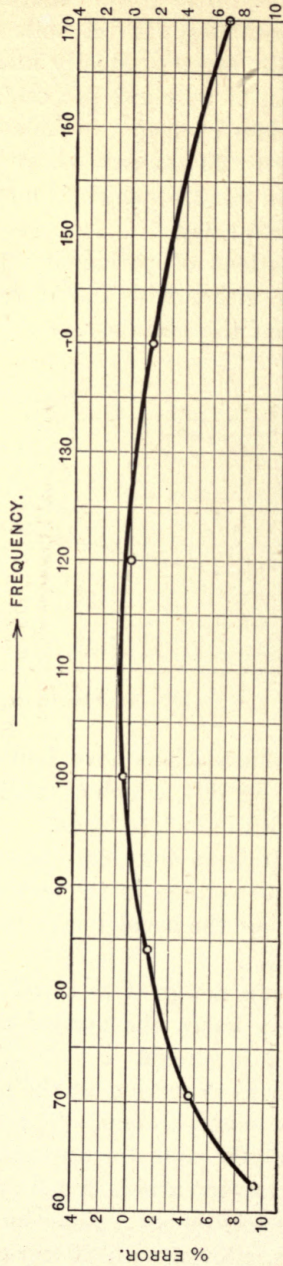

Fig. 324.—Error Frequency Curve of Alternating-Current Meter

Fig. 325 shows a sectional elevation of the clamping device provided in all these meters. The moving system is clamped by turning the milled-head screw *R* counter-clockwise to its full extent. This operation forces out the three pins *S*, which lift the bell *G* out of the lower jewelled bearing and clamp the whole moving system against the top support. The moving system should always be clamped when the meter is moved about.

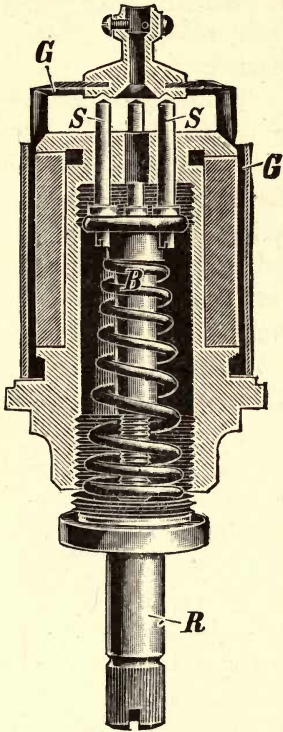

Fig. 325.—Clamping Device in Electrical Company's Meter

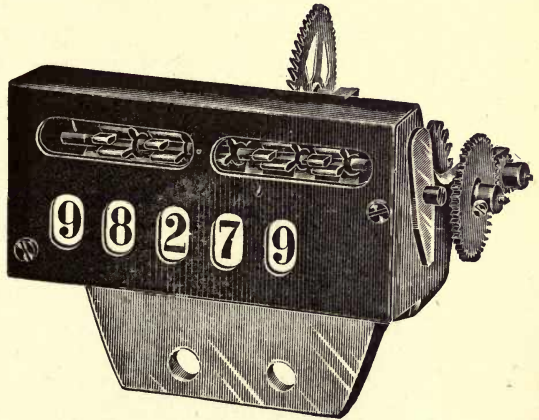

Fig. 326.—Recording Gear of Electrical Company's Meter

the other, so that it is almost impossible to make an error in reading the record.

Fig. 326 shows the recording gear detached from the meter. It is driven from the motor spindle through worm gearing.

The Electrical Co.'s Alternating-Current Electricity Meter— "Small Type"

The meter, now made for any current-strength (transformers being used above 100 amperes), consists of a rotating disc *A* (figs. 327 to 329), acted on by two magnetic fields differing in phase, which, by a special arrangement, produce a comparatively strong turning moment.

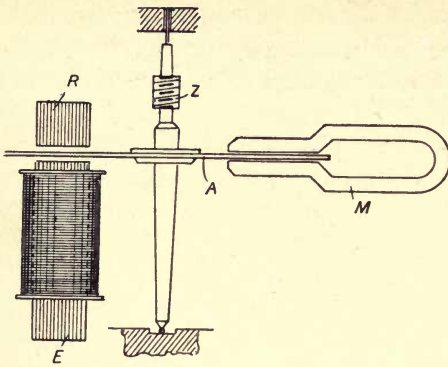

Fig. 327.—Principle of Electrical Company's "Small Type" A-C Meter (elevation)

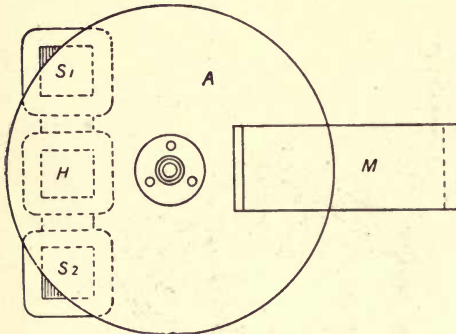

Fig. 328.—Principle of Electrical Company's "Small Type" A-C Meter (plan)

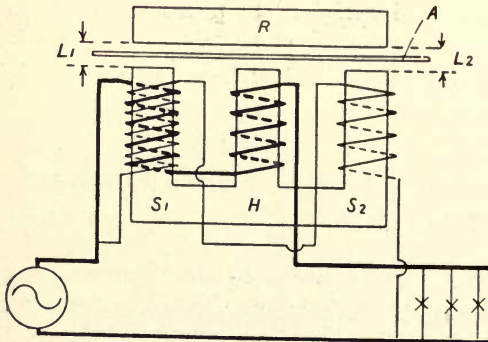

Fig. 329.—Connections of Electrical Company's "Small Type" A-C Meter

The fields are so arranged that they both act on the same portion of the rotating disc, their action being inter-dependent.

The magnetic circuit is a closed one. The shunt coils, as well as the main coils, are all arranged on one side of the rotating disc, and are wound on the three limbs of the same magnet yoke *E*, the armature *R* closing the magnetic circuit.

The action of the meter is as follows:—

The two shunt coils (S_1 and S_2) alone produce on open circuit a fairly powerful torque as long as either the air-gaps L_1 and L_2 , corresponding to the two pressure coils, or the magnetic effect of the two coils, is different. This torque would cause the meter to run idle, and therefore has to be compensated for up to a certain amount necessary to overcome static friction. This can be effected by altering either the number of turns on the coils or the air-gaps, and for this purpose the latter is adjustable.

The main-current coil H is wound on the same electro-magnet E , likewise producing a closed magnetic circuit. Hence there is, on the one hand, an interaction between the magnetic field of the main-current coil and the eddy currents due to the shunt coils, and on the other an interaction between the magnetic field of the shunt coils and the eddies due to the main-current coil, resulting in a rotation of the disc A .

The field due to the main-current coil affects the fields of the shunt coils, weakening the one and strengthening the other (fig. 329). The latter pole would with increasing load become saturated before the other, disturbing the proportionality. To prevent this, a part of the main-current windings is placed on this limb (fig. 329) to compensate for the inequality of the field in the iron yoke.

The same effect could be produced by varying the shunt coils. This, however, as pointed out above, would cause the meter to run idle.

With this arrangement both the limbs carrying the shunt coils become saturated simultaneously.

The rotation of the disc A is directly proportional to the product of the voltage and current. The instrument is, therefore, a watt-hour meter.

Figs. 331 and 332 show the interior and exterior views of the meter.

The revolutions of the disc are conveyed to the counting mechanism through worm gearing, and so continuously integrated.

The reading follows direct in B.O.T. units from the counting

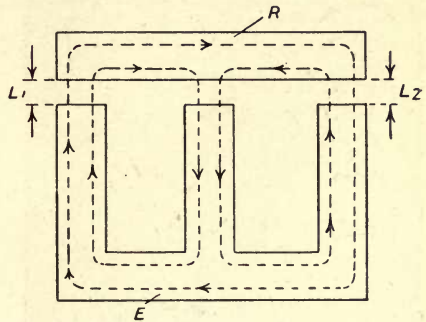

Fig. 330.—Magnetic Circuit of Electrical Company's "Small Type" A-C Meter

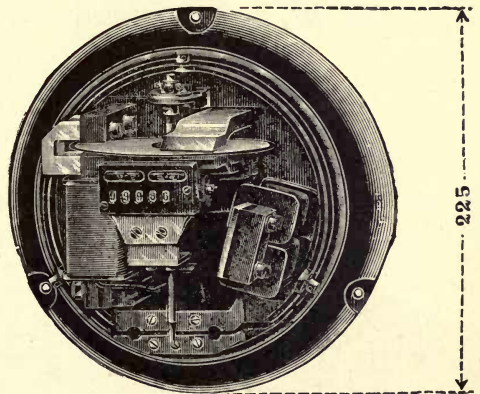

Fig. 331.—Interior of Electrical Company's "Small Type" A-C Meter

mechanism, the figures of which spring into position, so that the consumer can tell at a glance how many units he has consumed, *i.e.* what he has to pay the supply company.

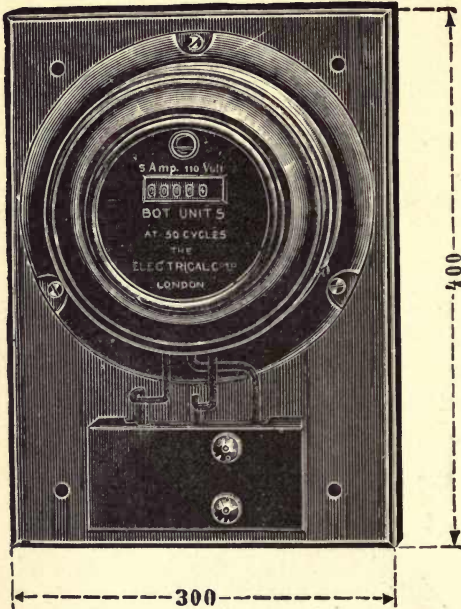

Fig. 332.—Exterior of Electrical Company's "Small Type" A-C Meter

The moving system of the meter only weighs about 30 grains, so that there is practically no wear at the bearings and pivots.

The curve, fig. 333, shows the accuracy of the meter for the whole range of the meter, *i.e.* from 4 per cent up to full load.

Such variations in voltage and periodicity as usually occur in practice are without effect on the above error curve.

The meters do not run idle on open lamp circuit. On the other hand, the instruments readily start

with 1 per cent of their maximum capacity.

The shunt loss in the meter is constant and is 1 watt per

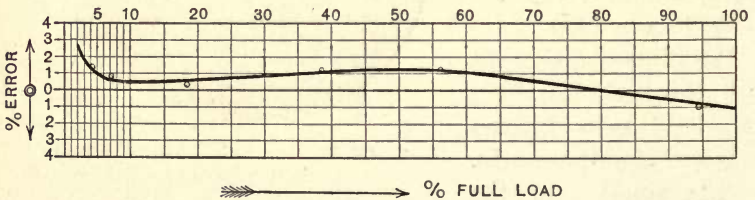

Fig. 333.—Error Load Curve of Electrical Company's "Small Type" A-C Meter

100 volts, whereas in the main coil the loss at full load never exceeds $1\frac{1}{2}$ watts.

The meter is made for voltages up to 250 volts, and for currents up to 100 amperes, but for higher voltages and currents the same meter may be used with transformers.

High-Tension Alternating-Current Meters

The general method adopted for measuring electrical energy in high-tension circuits is to employ a static transformer to reduce the

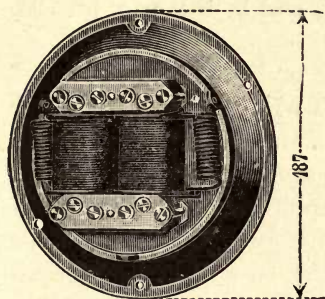

Fig. 334.—Interior of High-Tension Choking Coil

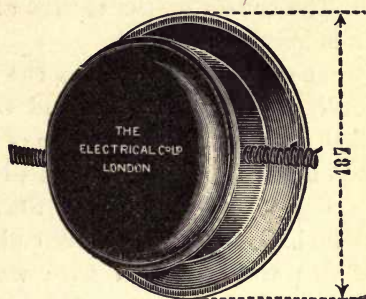

Fig. 335.—Exterior of High-Tension Choking Coil

high pressure to a low one, and then use an ordinary low-voltage electricity meter.

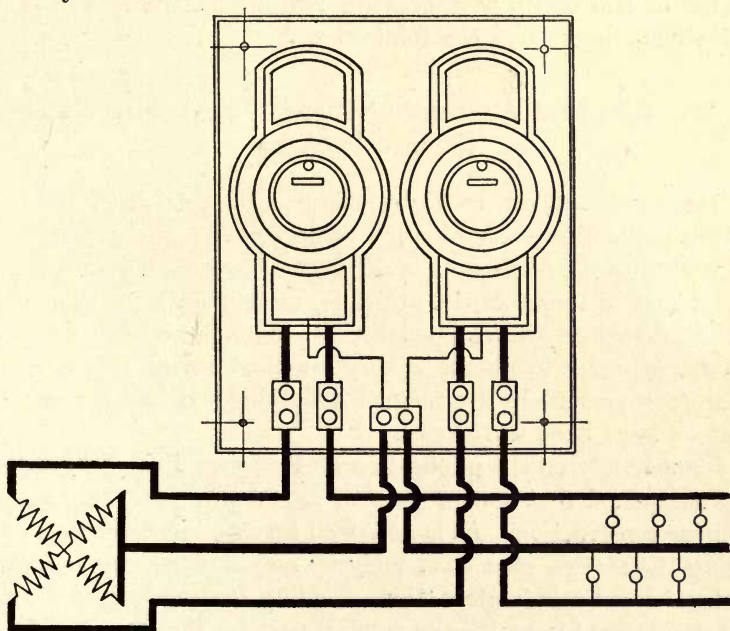

Fig. 336.—Connections of two Meters for Two-Phase Three-Wire System

The Electrical Co., London, however, supply high-tension alternating-current meters, which differ from the ordinary types

in being insulated throughout with mica, and more especially in the use of the so-called high-tension choking coils, which are placed in the shunt circuit of the meter and dissipate the superfluous voltage.

The covers of the meters are earthed, and in this way all risk from shock is avoided.

The above method has the advantage of being independent of the lag between current and voltage met with in the transformer used in other cases, and also of the transformation ratio, and while it is better and more accurate, it is at the same time simpler.

Figs. 334 and 335 show the internal and external appearance of these high-tension choking coils, which merely consist of two coils of fine well-insulated wire wound on the two limbs of a well-laminated closed magnetic circuit. This arrangement is clearly indicated in fig. 334.

In the case of polyphase circuits, the energy consumed in two-phase three-wire systems is obtained, as indicated in fig. 336, by the use of two ordinary alternating-current meters, when the sum of their readings gives the total energy.

The Hookham Alternating-Current Electricity Meter (Square Pattern)

The present meter, made by Messrs. Chamberlain & Hookham of Birmingham, is a combination of an electric motor, founded on the well-known experiments of Professor Ferraris, with an electric brake; and is therefore, in principle, merely an extension of the method described and claimed by Mr. Hookham's earlier patents, though, in order to obtain a very simple form of meter, and to ensure permanence in the magnet supplying the brake, new modifications have been introduced.

Immediately on the publication of Professor Ferraris' results, it was recognized that such a form of motor was peculiarly adapted to meter construction. As is now well known, he succeeded in producing the motion of a solid body by means of currents produced in that body by induction; thus avoiding the necessity for actual contact of any kind with the moving part for the purposes of conveying current to that part. By this means the prime difficulty of motor meters, the effect of friction at small loads, is almost entirely overcome.

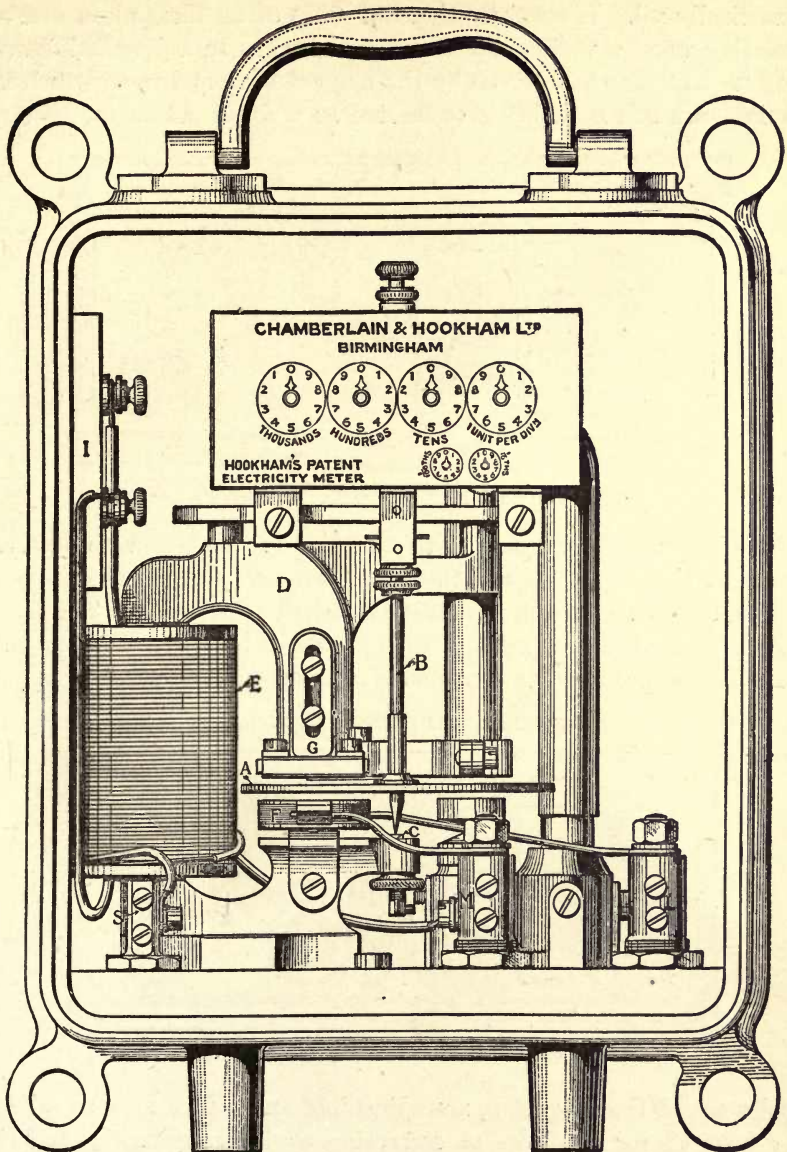

Fig. 337.—Interior of Hookham A-C Meter (Square Pattern)

The present meter, depicted in fig. 337, with door removed so as to show the interior, can be made to consume less than 2 watts in the shunt circuit; while the fall of potential at full load is

U

practically nil. It consists (figs. 337-339) of an aluminium disc A rotating upon a vertical spindle B, which runs in a jewelled bearing c. The disc A is driven by the magnet D, wound upon which is a fine-wire coil E, which is connected as a shunt across the mains,

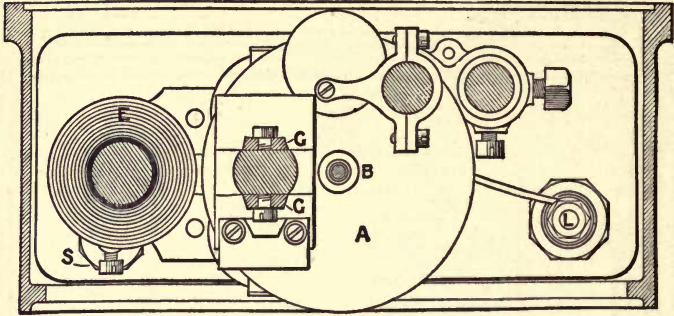

Fig. 338.—Plan of Working Parts of Hookham A-C Meter (Square Pattern)

and gives a field varying with the E.M.F. Between the lower poles of the magnet D and the disc A are two flat spiral coils FF, which carry the current which it is desired to measure. The field produced by the coils FF, and that produced by the coil E, are out of phase, so producing a continuous rotation of the disc. The upper

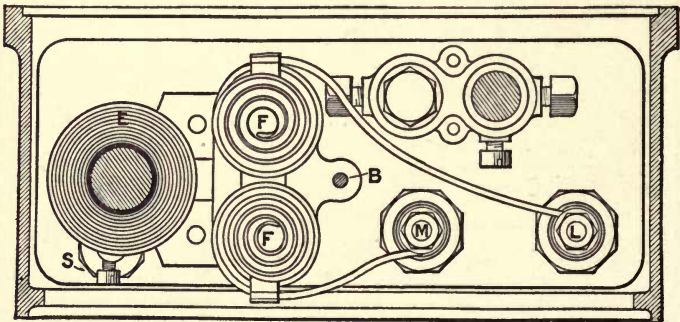

Fig. 339.—Plan of Working Parts of Hookham A-C Meter (Square Pattern)

poles GG, of the magnet D, are adjustable, and either may be raised or lowered for the sake of correcting slight irregularities in the curve of the meter.

The coils above described are connected to the circuit by three terminals marked S, M, and L. One end of the coil E is connected through S to one of the main circuit wires, and its other end to terminal M. The other main wire is connected to terminal M, and

the wire carrying the current to the lamps is connected to terminal L. A fuse I is interposed in circuit of coil E.

All parts of the meter are mounted upon a slate base which is fixed inside the cast-iron box, and is itself further insulated from the box by means of ebonite bushes and supports.

During transit, the armature is raised off its jewel bearing by means of a lever beneath it. This lever is actuated by a milled-head screw depending below the front edge of the disc. The lever should be lowered as far as it will go, after the meter has been fixed. The screw can easily be reached by the finger and thumb inserted on opposite sides of the bar which crosses the lower opening in the cover; the cover need not, therefore, be opened for this purpose.

This meter has the advantage of possessing only one moving part, and of having no mercury, no commutator, and no moving contact or clock-work.

It is an energy meter, reading direct in Board of Trade units, and has brake magnets that are quite permanent. The fall of potential at full load is so small as not to appreciably affect the lamps, while the consumption of energy in the shunt magnet is negligibly small.

The meter is only suitable for non-inductive circuits, such as lamps, but can be made so for inductive ones, when desired, by slight alteration. It is not independent of the periodicity of the current.

The Hookham Alternating-Current Electricity Meter (Round Pattern)

This is only a variety on the square-pattern alternating-current meter just described, to which it is similar both in principle and construction. Like the pattern above mentioned, it is suitable for measuring the current supplied to electric incandescent lamps, *i.e.* non-inductive circuits, but will not correctly record that supplied to arc lamps or motor, *i.e.* inductive circuits. It possesses all the advantages of the square pattern, and, like that, is dependent on the periodicity of the current.

Fig. 340 illustrates the inside view taken from the back.

The armature M and the worm which drives the worm-wheel and counting train, are carried by a vertical spindle running between

the top and bottom jewelled centre-screws (see fig. 340). The shunt coil is seen on the extreme right-hand side, and the series coil, which produces the rotating field that drives the armature M, on one pole of the electro-magnet. A small piece of sheet-iron k will

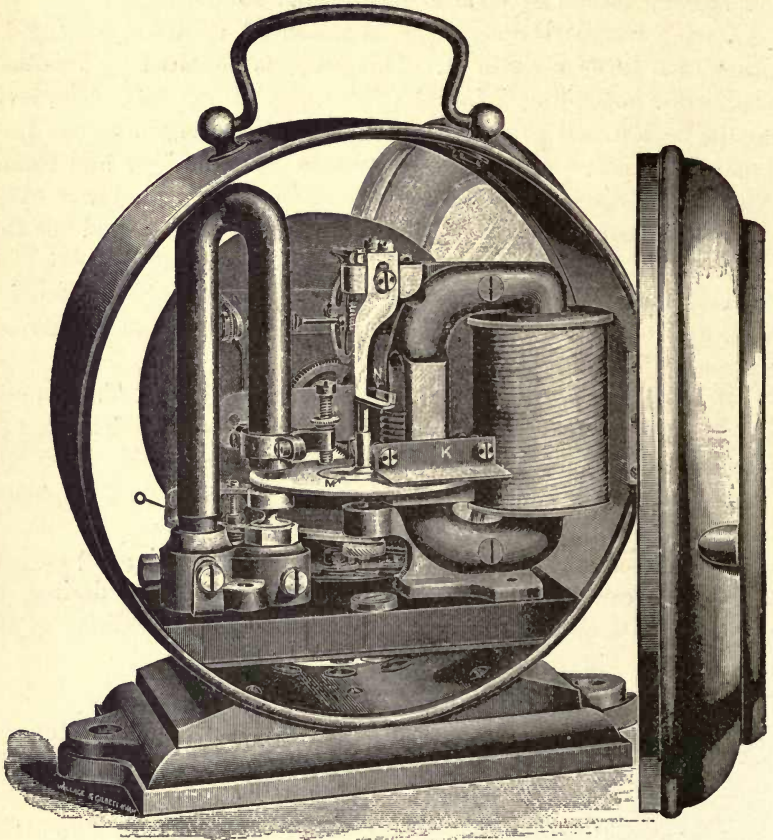

Fig. 340.—Interior of Hookham A-C Meter (Round Pattern)

usually be found attached to one of the four screws—this is for neutralizing any tendency of the meter to run one way or the other, when the shunt winding only has current passing through it. Its effect is regulated by using a larger or smaller one, as may be necessary, and by bending it closer to or further from the armature. It is put on the back or front of the meter, as may be required.

A lever not seen in fig. 340 holds the armature M up against the pole-pieces during transit, and releases it by unscrewing the milled

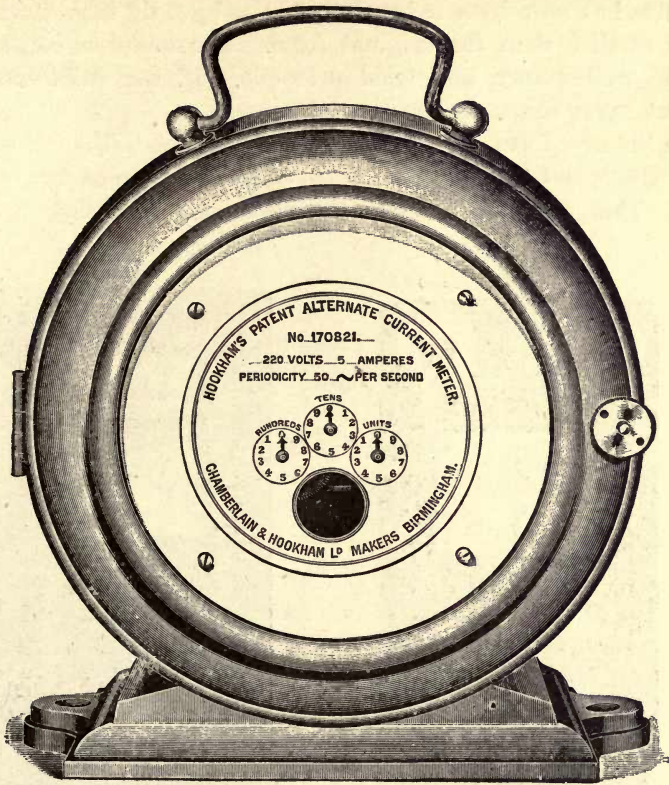

Fig. 341.—Exterior of Hookham A-C Meter (Round Pattern)

screw head *o* as far as it will go. Fig. 341 illustrates the general outside appearance of the meter as fixed for working.

The Aron Electricity Meter

The original form of meter, due to Dr. Aron, and made by the General Electric Co., London, has, up to within the last three or four years, been used commercially to some considerable extent. The meter, as now made, is a much-improved form, and has been approved by the Board of Trade for both direct and alternating currents, to either of which it is equally applicable.

This new and improved form of Aron meter is illustrated in fig. 342, with cover removed to show the internal construction, and in fig. 343 with cover on to show the general outside appearance.

The size has now been reduced to $15\frac{1}{2} \times 7\frac{1}{4} \times 6\frac{3}{4}$ inches, which is much smaller than the original form. The meter is constructed on the well-known and tried principle, viz. the influence of a current upon the swinging pendulum.

In the new form, both pendulums are subject to the influence of the current, and the difference between the two is registered on the dials. This meter belongs to the class of instrument in which

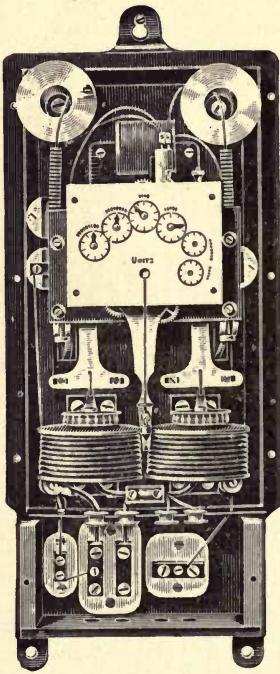

Fig. 342.—Interior of Aron Meter

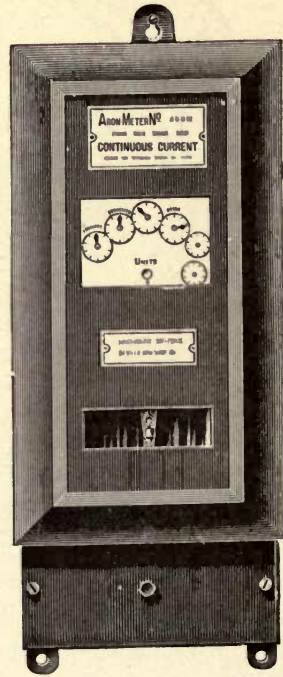

Fig. 343.—Exterior of Aron Meter

clocks are affected, and is self-starting, as soon as the requisite voltage has been applied to the terminals, with the smallest appreciable current, *i.e.* a 1000-ampere meter registering the energy used in an 8-candle-power lamp.

It can be used either as a coulomb or energy meter, reading direct in Board of Trade units, and is equally accurate and proportionate throughout its entire range on either direct or alternating-current circuits, whether inductive or non-inductive.

It has the further advantages of standing an overload of about 50 per cent without injury; it is *self-winding*, and does not require

synchronizing, and it is unaffected by external magnetic field or by variations of voltage.

By the kind permission of the proprietors of *The Electrical Engineer* I am enabled to give a reprint of a *résumé* of Dr. Aron's paper describing his new meter, which appeared in the issue of July 9, 1897, and which is illustrated from the blocks appearing in the *Elektrotechnische Zeitschrift*.

The new instrument (fig. 342) is essentially of the same principle as all electricity meters of the Aron type—that is to say, the influence of the current on the swinging pendulum is recorded. For about twelve years these instruments have done good service to the electrical industry, but they had the disadvantage that too much clock-work was used in them, and depended on, for accuracy. By introducing the differential counter about ten years ago, Dr. Aron eliminated many of the faults of the clock-work, such as the necessity of comparing the reading of the meter against the standard time. Nevertheless, the meter had other disadvantages in connection with the clock-work, which for practical purposes were often inconvenient: the clocks had to be wound up periodically, they had to be regulated, the pendulums had to be put in motion to start the clocks. All these disadvantages have now been got rid of to such a degree that the Austrian Board of Trade (Kaiserlich-Koenigliche Normal-Aichungs Commission) has passed this new type, and has declared these meters to be portable after they had been tested and sealed by the authorities.

The principal differences between the new Aron meter and the old type are that the new metre is wound up electrically, has very small pendulums, and is therefore portable without the necessity of clamping them. It also starts itself when the necessary E.M.F. has been applied to the terminals. It has a synchronizing arrangement, and measures correctly even when the two pendulums are not regulated and in absolute synchronism.

Theory.—The short and light pendulums used in this new meter are about 4 inches long, and make about 12,000 single oscillations per hour. They are so sensitive under the influence of current that each of them at full load shows a difference of about 2500 oscillations per hour.

With so large variations of the period of the pendulums the quadratic member of the formula developed in the theory of the

instrument is objectionable, and the meter would not record correctly within the whole range.

Thus, if n be the normal number of oscillations, N the varied number, J the intensity of the current, C a constant, then

$$N = n \left(1 + \frac{J}{2C} - \frac{J^2}{8C^2} + \dots \right).$$

To eliminate the quadratic member both pendulums are influenced in the reverse direction. Then we have the difference,

$$N_1 - N_2 = n \left(1 + \frac{J}{2C} - \frac{J^2}{8C^2} \right) - n \left(1 - \frac{J}{2C} - \frac{J^2}{8C^2} \right)$$

$$\text{hence } N_1 - N_2 = n \frac{J}{C},$$

therefore $N_1 - N_2$ is exactly proportional to J .

As each pendulum goes alternately forward or backward, the

quadratic member of the formula is eliminated during the whole period of one reversal. This is the case practically in the three-wire, five-wire, and multiphase-current meters, where each pendulum is used for each circuit. With the two-wire meters both pendulums are influenced by the same circuit, and so the sensibility is doubled.

Another advantage obtained by using two pendulums of nearly the same periodicity is this: That the shunt coils of the pendulums being provided with the same number of turns, and receiving the current in the same direction, are astatic against external influences.

If any undue influence is being exercised—for instance, by terrestrial magnetism—it will act equally on both clock-works and make both of them equally deviate from the true

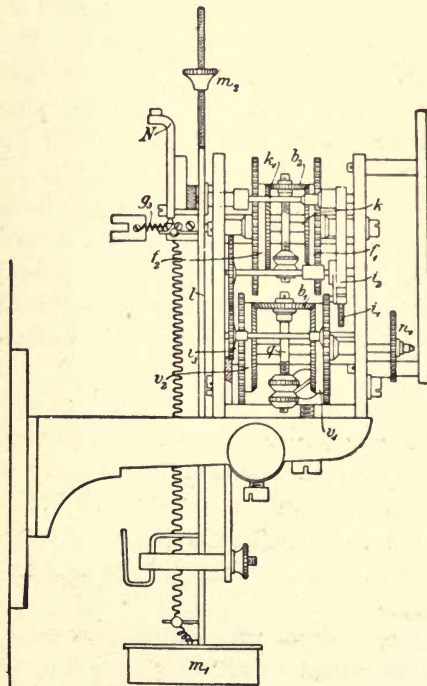

Fig. 344.—Aron Meter—Side Elevation of Mechanism

time. No difference will accordingly be indicated on the differential dial.

Description of the Clock-work.—The movement (figs. 344, 345, and 346) consists of two clock-works with escapement-wheel and pendulum, which are connected to a third wheel train, the differential counter (qq, v_1, v_2, b_1) giving the difference of their movements. A second stronger-built differential gear serves to transmit the common driving power to both wheel trains in such a manner as to allow to each of the two clock-works, motion independent of

each other. The motive power of the driving mechanism is transmitted to the axis, q , by a spiral spring in such a manner as to allow it to rotate only in one direction. This spiral spring at the same time serves to drive the clock-work during the small period in which the clock is being wound up.

The vertically-mounted shaft or axis q carries the loosely-mounted planet-wheel b_2 , which is in gear with the two crown-wheels f_1 and f_2 .

As soon as the shaft is in rotation, the planet-wheel b_2 will turn and impart motion to the crown-wheels f_1 and f_2 . As long as

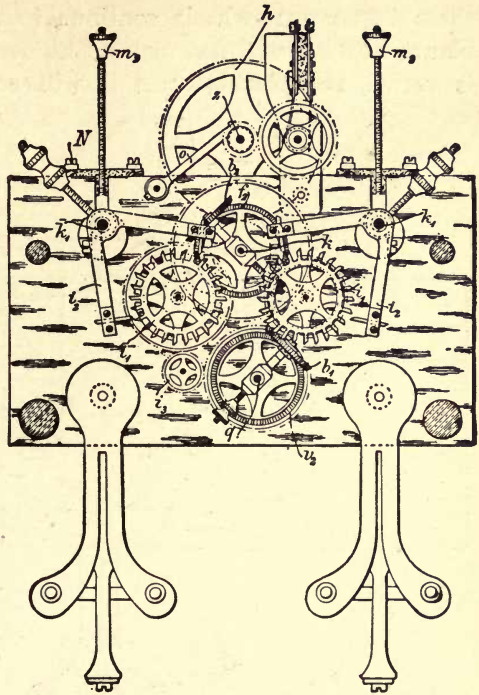

Fig. 345.—Aron Meter—Front Elevation of Mechanism

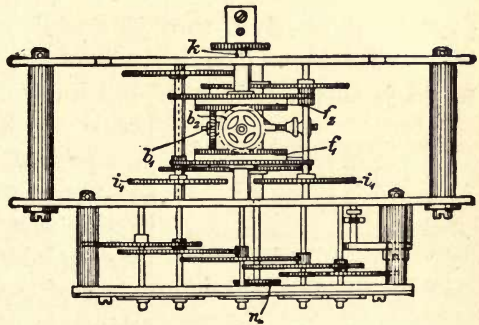

Fig. 346.—Aron Meter—Plan of Recording and Differential Gear

these two crown-wheels continue to run with equal speed, the planet-wheel b_2 will not turn on its own shaft. Now if the speed is varied, the planet-wheel b_2 will commence rolling along the cylindrical gear of that crown-wheel which is

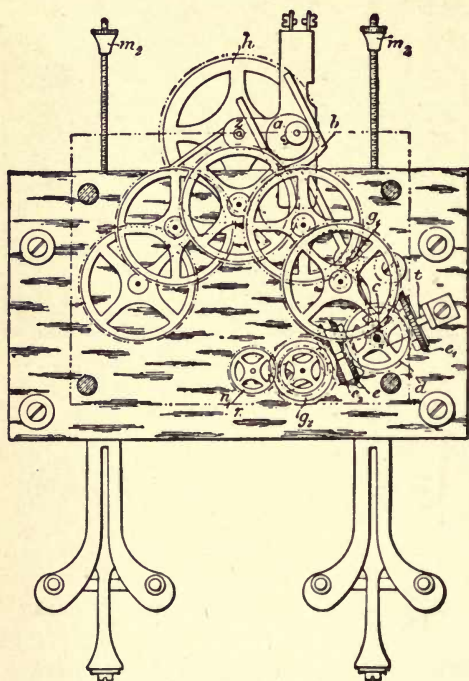

Fig. 347.—Aron Meter—Front Elevation of Reversing Mechanism

running slower than the other. So both crown-wheels are at any time under the influence of the same driving power without their various speeds being disturbed.

Each crown-wheel is geared with a clock train and escapement i_1 , with two pendulums provided with palettes, &c., on levers of the Graham type. In order that the direction of rotation of the two trains may, in spite of the common driver, be in opposite directions, the right train escapement is connected directly, while the left

escapement is driven through an idle axle i_3 to change the direction of rotation. The rotation of the axle of the central bevel-wheel g_3 then gives, as is well known, the difference between the period of the two pendulums. Of the two sets of crown-wheels, the axle of the upper sets k rotates in proportion to the sum of the oscillations of the two pendulums. On the other hand, the axle g of the lower set of crown-wheels rotates in proportion to the difference

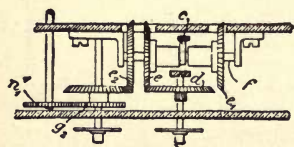

Fig. 348.—Aron Meter—Plan of Reversing Mechanism

of the number of oscillations of each pendulum. The lower axle drives the counting gear. The pendulums are rigidly fixed to the axle k_1 of the two anchors carrying palettes. The pendulums are each provided with a shunt coil at their lower ends, which act as

of the number of oscillations of each pendulum. The lower axle drives the counting gear. The pendulums are rigidly fixed to the axle k_1 of the two anchors carrying palettes. The pendulums are each provided with a shunt coil at their lower ends, which act as

weights. Two connections to each of these coils are made by two loops of thin insulated copper wire from the contacts N.

Two regulating weights m_2 are shown, one on each pendulum, in the illustration (fig. 345), but a single weight has been found to be sufficient.

Reversing Apparatus.—The next part of the apparatus to be described has for its object the correction of any fault due to small deviation of the natural period of either pendulum. To do this, the direction of the shunt current in the pendulum coils is reversed at stated intervals, and at the same time the gear driving the counter is reversed so that the record may be continuous in direction. In this way a fault which is acting in one direction, say, to register

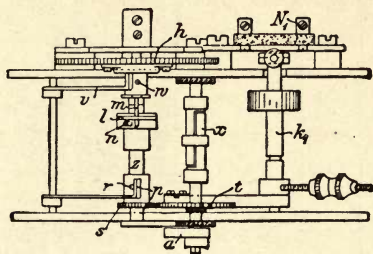

Fig. 349.—Aron Meter—Plan of Reversing Mechanism

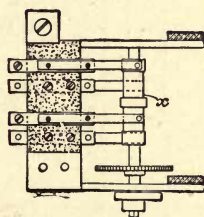

Fig. 350.—Aron Meter—Plan of Reversing Commutator

too much in the first period, after reversal acts in the opposite direction and registers too little in the second period. The apparatus for effecting this change can be seen in figs. 347, 348, 349, and 350. The large wheel h is caused to rotate by the clock-work once in about twenty minutes. During its revolution it winds up the spring l . At the end of the revolution the trigger n lifts the lever v , which is on the same axis as the locking lever r . This being lifted allows the axis z to fly round through 360° . This axis being geared to the commutator x moves it round through 180° , and reverses all the shunt connections. At the same time the eccentric a on the end of the commutator axle, acting on the lever b , reverses the mechanical connection between the differential clock-work and the counting gear. The direction of rotation only is reversed, and this is done by means of the bevel-wheels e_1, e_2 , which slide on a sleeve, so that one or other only of the wheels is in gear.

The Winding Gear.—The winding-up gear for the clock-work is shown in figs. 351 and 352. It consists of a horse-shoe magnet

a, with poles shaped so as to permit of the armature revolving within them. In this way a large range of motion can be easily given to the armature. Inside the armature *b* is placed a small watch-spring *g*, which is wound up about once every thirty seconds. The arrangement of pawls and clicks can be seen from the two illustrations. Attached to the armature is a contact *y*, which is connected through *x* by the spring *r* to the shunt coil on the magnet. The contact *y* engages with a little throw-over switch *e* which

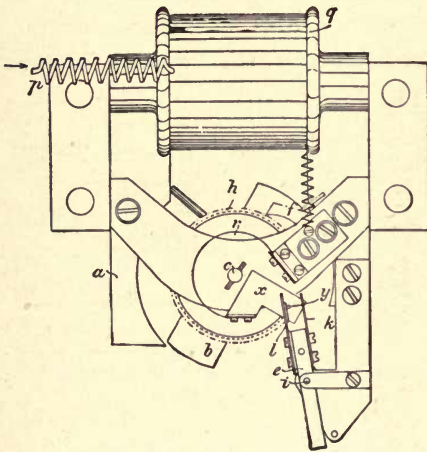

Fig. 351.—Aron Meter—Front Elevation of Winding Gear and Electro-Motor

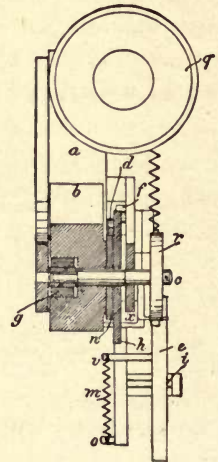

Fig. 352.—Aron Meter—Side Elevation of Winding Gear and Electro-Motor

rotates round an axis *i*. The position of this switch is partly controlled by a spiral spring *m*, which makes it rest either on one side or the other of a given centre line.

When the clock runs down, the armature *b* slowly revolves away from the poles, the contact *y* being against the insulated spring *k*. At a certain point the spiral spring *m* gets over the centre and reverses the switch, and contact between *y* and *l* is then made. This energizes the magnet coils, and the armature again winds up the clock. The contact is a rubbing one, tending to keep itself clean, and the breaking point is not at the same part where the circuit is made.

The ordinary connections of the meter are shown in fig. 353, which is for a two-wire system. The two current coils *ss* are connected in series with the lamps to be supplied. The shunt coils *ss*

are also in series, and a large external resistance R is also placed in this circuit, so that the energy taken by the meter is small. This is from one to two watts, according to the size of the meter. The connection O is removed when a number of these meters are to be tested, and the current coils then can all be connected in series and the shunts in parallel.

The meter is equally applicable to direct and alternate current working. The special advantage of the meter for the alternate-current circuit is that it is a watt-meter, and is independent of the periodicity of the supply, and also of any difference of phase there may be between the current and the E.M.F. In other words, the meter measures true power. The magnet of the winding-up gear requires to be arranged to suit the frequency, but this is without any influence on the measuring parts of the meter. The meter is extremely sensitive, being affected by exceedingly small currents, and measures correctly within the whole range from zero to the full load. The meter has also the advantage over some other types of having no permanent magnets, and it is independent of frictional losses such as are found in motor meters. The influence of a change in temperature is also corrected, and is found to be inappreciable.

The meters are calibrated to read direct in Board of Trade units, and they are available for use on any system of distribution.

The Aron Day and Night Load Electricity Meter

This instrument, devised by Dr. Aron and supplied by the General Electric Co., London, has been designed so that during the period of maximum load of the central generating station, consumers may be charged at a higher rate than during the light-load period in the daytime. Fig. 354 shows the meter with both doors

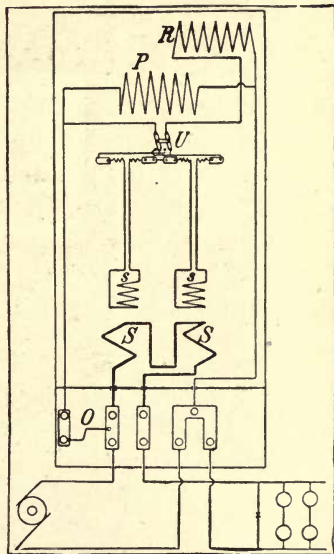

Fig. 353.—Connections of Aron Meter to Two-Wire System

open. It consists of an ordinary improved form of meter such as that just described, to which is joined an electrically-driven clock (on the left-hand side), both being self-contained in one case as seen. The electric clock is of the pendulum type, and can be synchronized to work correctly to within two or three minutes per month. It has sufficient reserve power, so that even if the current is switched off, the clock will work for a period of two or three

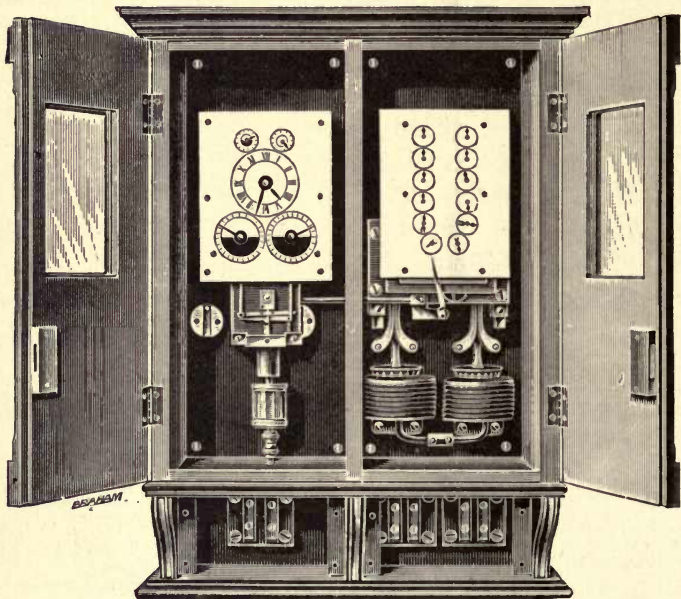

Fig. 354.—Aron Day and Night Load Meter

days. This electrically-driven clock is so arranged that by means of adjusting the hands on the separate dials, a lever is operated at any two periods within twenty-four hours. This lever puts into gear the motion wheels of either set of dials, according to the period at which it has been set. The meter has the great advantage that the *current is never interrupted* even when change of rate is made, the motion gear of the dials only being altered, and the current consumed registered on the day or night loads as the case may be. A further advantage is that the consumer can at any time see at which rate he is being charged, and also what current is being consumed at each rate.

Direct-Current Time-Check Meter

This instrument, made by the Electrical Co., London, though not an electricity meter in the ordinary sense of the word, is, under certain conditions, made to do the duty of one, and registers the *hours of supply*. The principle on which it works will be understood from the diagrammatic view of the arrangement shown in figs. 355 and 356. It consists of an electro-magnet, the coil of which may be either series wound with thick wire, and connected

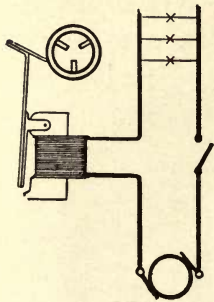

Fig. 355. — Principle of Electrical Company's Direct-Current Time-Check Meter (Circuit Open)

in series with one main, or shunt wound with fine wire, and connected across the mains. The former being the arrangement illustrated.

The poles of this electro-magnet actuate a soft-iron armature pivoted to one of them, and carrying a spring strip on an extension. This strip controls the balance-wheel of a

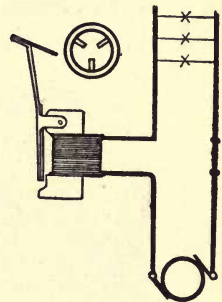

Fig. 356. — Principle of Electrical Company's Direct-Current Time-Check Meter (Circuit Closed)

clock. Hence time-checks are clocks actuated by means of an electro-magnet, when a certain predetermined strong current is passed through the windings, but it is otherwise mechanically prevented from going. When the apparatus is switched into circuit, the clock-work starts, and only stops on the circuit being broken. The time-check thus indicates the number of hours during which current has been flowing in the circuit. When once the armature of the electro-magnet has been attracted and the clock-work released, any alteration in the strength of the current will not affect the working of the time-check, which only measures the duration of the flow of current and not the current strength. The balance of the clock mechanism is arrested by means of a spring attached to the armature. The tension of the spring is such that at about one-tenth of the maximum load for which the meter is made the spring is pulled back by the electro-magnet of the clock, the catch released, and the clock-work set in motion.

Fig. 355 shows the main circuit open and the clock stopped, while fig. 356 shows the circuit closed and the clock released. It

has been found that for the operation of the time-checks the best relation between the starting and maximum current should be 1 to 10; *e.g.*, a time-check for a maximum of 10 amperes should be started with 1 ampere; further, that a time-check starting with 0.3 ampere should not be used for a higher current than 3 amperes.

They are employed as controlling instruments for the current taken by a consumer from electricity works, and principally in cases where the consumption is very approximately a constant one, so that it is sufficient to know the length of time of taking current in order to obtain the amount chargeable; *e.g.*, two 9-ampere arc lamps, in series, on a 110-volt circuit would consume constantly in

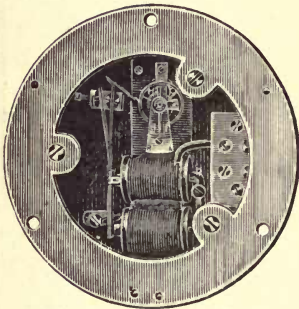

Fig. 357.—Electrical Company's Direct-Current Time-Check Meter (interior)

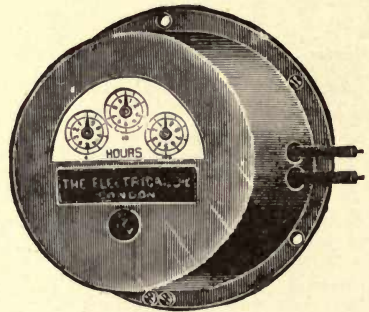

Fig. 358.—Electrical Company's Direct-Current Time-Check Meter (exterior)

round numbers 1 kilowatt. Having then determined, by means of the time-check, the number of hours the lamps have been burning, the consumer can be told at once the number of kilowatt hours he has to pay for. In the same way the time-check may be used with advantage for measuring the energy consumption in the case of heating apparatus, for which, as a rule, special cheap rates are charged. In other cases where the consumption is not a constant one, *e.g.* in small light installations, in which sometimes all the lamps installed, and at other times only a portion are burning, by arranging with the consumer to regard as constant a certain mean load, one can fix the energy consumption by means of the time-check.

Fig. 357 shows the internal view of one of these time-checks with back plate removed; while fig. 358 indicates the general appearance of the instrument in the front.

Small electricity works, which are unable to spend large sums

of money for watt-hour meters, will find this class of meter, even if it were only to give an approximate indication of the current used by the consumer, better than resorting to contract prices. For installations in which the current consumption varies between large limits, a special modification of the instrument is used, termed a "maximum current time-check". It is used in connection with the supply of current under contract on condition that the consumer does not exceed a certain limit. The function of the instrument is to give the length of time the consumption has exceeded the contract limit, and the clock-work is only released and free to work when a current flows through the winding of the electro-magnet in excess of the maximum current agreed upon.

The Aron Electric Time-Check

In small electric light systems, where the available capital will not admit of the somewhat heavy expenditure entailed in the use of the ordinary energy or coulomb meters, it is customary to charge

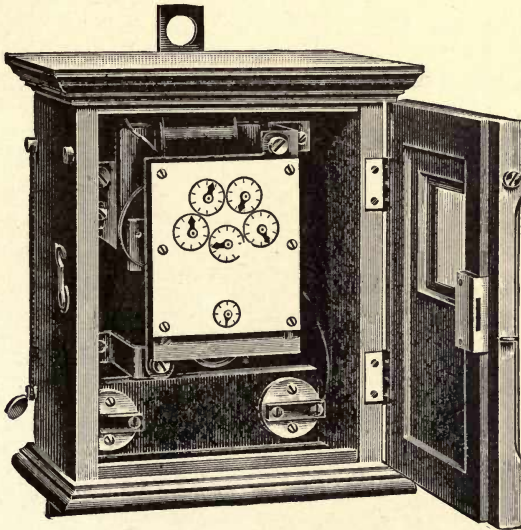

Fig. 359.—Aron Electric Time-Check Meter

for the supply by contract at the rate of so much per annum per lamp. This is on the understanding that the lamps shall not be used more than a certain number of hours, except in cases where fogs order otherwise. In many cases, however, such a system is

unsatisfactory, as customers often encroach through carelessness on the agreement, using the lamps for much longer periods than stipulated. In such cases it is far better to use an electric time-check, and fig. 359 shows the Aron type of this kind of instrument with door open, as supplied by the General Electric Co., London.

It records the total number of *hours* during which current is used, and consists of an ordinary clock with a non-magnetic main-spring. The balance-wheel of the clock is controlled by an electro-magnet energized by the supply to be timed. When the supply is started, the armature of the electro-magnet draws a spring off the balance-wheel, thus releasing and causing the clock to record the hours. When the supply ceases, the armature again engages the balance-wheel and stops the clock. The action is similar to that depicted on p. 319, and the electro-magnet may be shunt or series wound for connecting across or in series with the mains. This Aron time-check or hour meter is adaptable to any method of distribution, whether for direct or alternating current, at voltages up to 250.



APPENDIX

There are a few instruments which do not come quite within the scope and object of this work, but which act on very interesting principles, a knowledge of which may therefore prove instructive.

The following are references to the descriptions of these:—

- Ayrton and Mather's "Moving-Coil Ammeter". Deschanel's *Natural Philosophy*, Part iii, p. 141.
- Swinburne's Electro-static Voltmeter (Holt's Patent). Maycock's *Electric Lighting and Power Distribution*, Vol. i.
- Swinburne's "N" type astatic Voltmeters and Ammeters. Ditto.
- " "U" type Inductor " " " Ditto.
- Paterson and Cooper's "Phoenix" Ammeters and Voltmeters. Ditto.
- The Walsall Ammeters and Voltmeters. Ditto.
- Swinburne Wattmeter Ammeters and Voltmeters. Ditto.
- Ayrton and Perry's Twisted-Strip Ammeters and Voltmeters. Ditto.
- Ayrton and Perry's Hot-Wire Ammeters and Voltmeters } Slings & Brooker's
 " " Magnifying-Spring Ammeters and } *Electrical Engin-*
 Voltmeters } *eering.*
- Mordey's Alternating-Current Wattmeter. *Jour. I. E. E.*, Vol. xxx, No. 149, p. 384.
- Holden's Watt-Hour Meter. *Jour. I. E. E.*, Vol. xxx, No. 151, p. 944.
- Evershed's Frictionless Motor Meter. *Jour. I. E. E.*, Vol. xxix, No. 146, p. 743.

INDEX

- "Ageing" of magnets, 20, 100.
Air-damping devices, 31, 36.
Air-friction control, 6.
Ammeters, classification of, 3.
Ammeter, compensating alternating-current, principle of, 80.
— Davies' moving-coil permanent-magnet, 87.
—, Electrical Co.'s electro-magnetic moving-coil, 79.
—, Electrical Co.'s moving-coil permanent-magnet, 91.
—, electro-static, Voysey & Wilson's, 150.
—, Evershed moving-coil permanent-magnet, 95.
—, Hartmann & Braun moving-coil permanent-magnet, 108.
—, hot-wire, Hartmann & Braun's, 137.
—, induction, Electrical Co.'s, 112.
—, —, Ferraris, 118.
—, —, Westinghouse, 120.
—, "N.C.S." moving-coil permanent-magnet, 99.
—, Parr's electro-magnetic moving-coil, 71.
—, recording, Everett, Edgcombe & Co.'s, 177.
—, —, Harrison's, 180.
—, —, Holden, 176.
—, —, Kelvin, 176.
—, Siemens' moving-coil permanent-magnet, 94.
—, Stanley moving-coil permanent-magnet, 101.
—, "Victory" moving-coil permanent-magnet, 110.
—, Weston arc-lamp, 106.
—, — moving-coil permanent-magnet, 101.
Ammeter, electro-magnetic moving-needle, Atkinsons', 20.
—, —, Castle, 54.
—, —, Dolivo, 44.
—, —, "E.E.C." Universal, 27.
—, —, Evershed, 33.
—, —, Harrison, 30.
—, —, Hartmann & Braun, 50.
—, —, Holden, Drake, & Gorham, 41.
—, —, Kramer & Co.'s, 26.
—, —, Miller's, 49.
—, —, "N.C.S.", 37.
—, —, pocket form, 23.
—, —, Schuckert, 53.
—, —, Siemens', 31.
—, —, Stanley, 45.
—, —, "Victory", 56.
Ampere gauge, Kelvin, 24.
— turns on different instruments, 10, 12, 40.
Apparent power, 153.
Appendix, 323.
Aron electricity clock meter, 309.
— — — — (day and night load form), 317.
Aron time-check meter, 321.
Astatic moving-coil permanent-magnet voltmeter, 60.
Atkinson ammeters and voltmeters, 20.
Ayrton & Mather's astatic moving-coil permanent-magnet voltmeter, 60.
— — high-tension electro-static voltmeter, 139.
— — low-tension electro-static voltmeter, 143.
Balances, Kelvin standard centi-ampere, 186.
—, — — composite, 188.
—, — — electric, 183.
Bastian electricity meter, 205.
— electrolytic effect, 208.
Brake on Weston moving-coil voltmeter, 81.
Calibration curve of 10-ampere demand indicator, 235.
Campbell's frequency teller, 197.
Cardew's hot-wire voltmeter (low-reading form), 132.
— — — (ordinary form), 125.
"Castle" ammeters and voltmeters, 53.
Centi-ampere balance, Kelvin's, 186.
Chemical effect of a current, 2.
— electricity meter, 202.
Choking coils for high-tension meters, 303.
Clamping device of Electrical Co.'s electricity meter, 299.
Clark cell, 190.
Coils, 9.
Compensating devices, 15, 29, 36, 37, 80.
Composite balance, Kelvin's, 188.
"Constantan" (a patent alloy having a high specific resistance and small temperature coefficient), 13.
Controlling forces—different forms, 5.
Copper sulphate (a chemical substance having the composition CuSO_4 , *i.e.* consisting of copper, sulphur, and oxygen), 212.
Correcting factor of wattmeters, 170.
Coulomb meters, 4, 201.
Creeping or magnetic lag, 8, 19.
Crompton standard potentiometer, 190.
Currents, how measured, 193.
Current transformer, principle of, 115.
— transformers, use of, 166.
Curves showing compensation for variation of temperature, 226.
— of temperature error, 236.
—, time, of demand indicator, 237.
Damping devices. See *Dead-beat or aperiodic devices*.
D'Arsonval galvanometer, 84.
Davies' moving-coil permanent-magnet voltmeter and ammeter, 84.

- Davies' voltmeter, bench form, 91.
 Dead-beat or aperiodic devices, 23, 25, 28,
 31, 36, 40, 60, 73, 77, 81, 92, 104, 108,
 119, 137, 146.
 Demand indicator, shunted type of, 238.
 —, special uses of Wright's, 242.
 —, Wright's thermal, 233.
 Dolivo ammeters and voltmeters, 44.
 Driving force in meters, 204, 273.
 Dynamometer instruments, moving-coil, 19.
- Earth-resistance indicator, Stanley, 199.
 Eddy currents, 38, 112, 165, 273.
 Edgewise instruments, 105.
 Edison's electrolytic electricity meters, 209.
 "E. E. C." ammeters and voltmeters of
 Everett, Edgumbe & Co., 27.
 Effects of an electric current (electro-mag-
 netic and electro-static), 2.
 Electric balances, Kelvin's standard, 183.
 Electrical Co.'s instruments—induction am-
 meter and voltmeter, 112.
 —, —, induction phasemeter, 194.
 —, —, induction wattmeter, 165.
 —, —, moving-coil dynamometer ammeter,
 79.
 —, —, moving-coil dynamometer volt-
 meter, 75.
 —, —, moving-coil permanent magnet
 ammeter and voltmeter, 91.
 —, —, moving-coil wattmeter, 169.
 —, —, neutral point resistance for instru-
 ments, 166.
 —, —, recording induction wattmeter,
 181.
 Electrical Co.'s motor electricity meter, 293,
 299.
 —, — motor electricity meter (high tension),
 303.
 —, — oscillating electricity meter, 250.
 —, — time-check meter, 319.
 —, — power, systems of distribution in use, 201.
 Electricity meters, 4, 201.
 Electricity supply meters—qualities needed
 for commercial success, 204.
 —, —, Aron clock, 309.
 —, —, Aron day and night load clock, 317.
 —, —, Aron time check, 321.
 —, —, Bastian electrolytic, 205.
 —, —, Edison electrolytic, 209.
 —, —, Electrical Co.'s induction motor,
 293, 299.
 —, —, Electrical Co.'s induction motor
 (high tension), 303.
 —, —, Electrical Co.'s oscillating, 250.
 —, —, electrolytic, 203-204.
 —, —, Ferranti motor, 258.
 —, —, Ferraris induction motor, 269.
 —, —, general remarks and classification,
 201.
 —, —, Hookham induction motor, 304, 307.
 —, —, Hookham motor, 261, 265.
 —, —, Kelvin's periodic integrating, 247.
 —, —, Long-Schattner electrolytic pre-
 payment, 211.
 —, —, Schallenberger motor, 284.
 —, —, Schattner electrolytic standard, 218.
 —, —, Siemens' periodic integrating, 244.
 —, —, Thermal (Forbes), 202.
 —, —, Thomson motor, 271.
- Electricity supply meters, Vulcan motor, 279.
 —, —, Vulcan prepayment motor, 283.
 —, —, Westinghouse induction motor, 288.
 —, —, Wright's electrolytic, 221.
 Electro-dynamometer, law of Siemens', 64.
 —, Siemens' moving-coil, 61.
 Electrolyte, "ageing" of, 208.
 Electrolytic cell of Wright meter, 222.
 —, electricity meters, Bastian, 205.
 —, —, Edison, 209.
 —, —, Long-Schattner prepayment, 211.
 —, —, Schattner standard, 218.
 —, —, Wright's, 221.
 Electro-magnetic control, 6.
 —, effect, 2.
 —, wattmeters, 153.
 Electro-magnets, 10.
 Electro-static effect, 2.
 —, instruments—Ayrton & Mather's high-
 tension voltmeter, 139.
 —, —, Ayrton & Mather's low-tension volt-
 meter, 143.
 —, —, Kelvin multicellular voltmeter, 144, 149.
 —, —, the theory of, 124.
 —, —, Voysey & Wilson's ammeter, 150.
 Energy waste in instruments, 14, 203, 255,
 282-283, 297.
 Erg meters or energy meters, 4, 201.
 Error curve, Bastian electrolytic meter, 207.
 —, large type oscillating meter, 255.
 —, Schattner standard meter, 221.
 —, small type oscillating meter, 253.
 —, Wright meter at light loads, 226.
 —, —, — at ordinary loads, 227.
 —, frictional, 150.
 —, heating, absence of, 131.
 —, — method of diminishing, 14.
 —, sources of, 12, 18, 153-154.
 "Eureka" (a patent alloy having a high
 specific resistance and extremely small
 temperature coefficient), 13.
 Everett, Edgumbe & Co.'s ("E. E. C.") watt-
 meters, 160.
 —, —, recording ammeters and voltmeters,
 177.
 Evershed ammeters and voltmeters, 33.
 —, moving-coil permanent-magnet ammeter
 and voltmeter, 95.
- Ferranti electricity motor meter, 258.
 Ferraris induction ammeters and voltmeters,
 118.
 —, — motor electricity meter, 269.
 Fleming & Gimingham's dynamometer volt-
 meter, 69.
 Forces, controlling, 5.
 —, deflecting, 90.
 Foucault current, damping, 6, 60, 94, 100,
 105, 112, 114, 136, 273.
 Frequency teller, Campbell's, 197.
 Fuse for Cardew voltmeter, 130.
- Galvanometer, D'Arsonval, 84.
 —, key, 192.
 "German silver" (a patent alloy consisting
 of 60 per cent of copper, 26 per cent of
 zinc, 14 per cent of nickel, having a high
 specific resistance and a small tempera-
 ture coefficient), 127.
 Gravity control, 6, 50, 60.

- Harrison ammeters and voltmeters, 30.
 Harrison's recording ammeter and voltmeter, 179-180.
 Hartmann & Braun, ammeters and voltmeters, 50.
 —, hot-wire ammeter, 137.
 —, hot-wire voltmeter, 134.
 —, moving-coil permanent-magnet ammeters and voltmeters, 108.
 Heating effect of a current, 2.
 High-tension choking coils, 303.
 Holden, Drake, & Gorham, ammeters and voltmeters, 41.
 Holden's recording am- and voltmeters, 173.
 Hookham electricity motor meter (direct-current), 261, 265.
 — induction electricity motor meter, 304, 307.
 Hot-wire ammeter, Hartmann & Braun, 137.
 —, Holden recording, 176.
 — instruments, the theory of, 123.
 — voltmeter, Hartmann & Braun, 134.
 —, Holden recording, 175.
 — (low-reading form), Cardew's, 132.
 — (ordinary form), Cardew's, 125.
 Hygroscopic liquids (*i.e.* liquids which rapidly absorb moisture), 234.
 Hysteresis error, 27, 38, 43, 50, 58.
- Illuminated-dial instruments, Weston's, 83.
 Indicator, uses of Wright's demand, 242.
 — Wright's thermal demand, 233.
 Induction ammeters and voltmeters, Electrical Co.'s, 112.
 —, Ferraris, 118.
 —, Westinghouse, 120.
 — electricity meter, Electrical Co.'s, 293.
 —, Westinghouse, 288.
 — in permanent-magnet instruments, 90.
 — instruments, 20.
 — phasemeter, Electrical Co.'s, 194.
 — recording wattmeter, Electrical Co.'s, 181.
 — wattmeter, Electrical Co.'s, 165.
 Inductors of Ayrton & Mather electro-static voltmeter, 141.
 Instruments, classification of, 3.
 —, electro-static, 124.
 — hot-wire, 123.
 — miscellaneous, 183.
 Integrating meters, 5, 202.
- Joule's meters, 4, 201.
- Kelvin's instruments — ampere and volt gauges, 24.
 —, engine-room wattmeter, 157.
 —, multicellular electro-static voltmeter, 144, 149.
 —, multicellular electro-static voltmeter multiplier, 147.
 —, periodic integrating electricity clock-meter, 247.
 —, permanent-magnet moving-coil recording voltmeter, 177.
 —, recording ammeters and voltmeters, 176.
 —, standard centi-ampere balances, 186.
 —, standard composite balances, 188.
 —, standard electric balances, 183.
 — three-phase wattmeter, 160.
 Kramer & Co.'s ammeters and voltmeters, 26.
- Lag, magnetic, 8, 19, 105, 157, 167, 170.
 Long - Shattner prepayment electrolytic meter, 211.
 Low-resistance shunts for instruments, 97, 107, 110, 112.
- M'Whirter patent magnetic shield, 47.
 Magnetic lag or creeping, 8, 19, 105, 167, 170.
 Magnetic shielding, 8, 32, 47, 52, 109.
 Magnets, astatically-arranged permanent, 60.
 —, electro-, 10.
 "Manganin" (a patent alloy consisting of 84 per cent copper, 12 per cent nickel, and 4 per cent manganese, having a high specific resistance and very small temperature coefficient), 13, 61.
 Measurement, branches of, 3.
 Mechanical or air-friction control, 6.
 Mercurous nitrate (a chemical compound having the composition $HgNO_3$, *i.e.* composed of mercury, nitrogen, and oxygen), 221.
 Metal suspension, torsion of, 6.
 Meters, electricity supply, remarks and classification, 201.
 —, Aron clock, 309.
 —, Aron day and night load clock, 317.
 —, Bastian electrolytic, 205.
 —, Edison electrolytic, 209.
 —, Electrical Co.'s high-tension motor, 303.
 —, Electrical Co.'s induction motor, 293, 299.
 —, Electrical Co.'s oscillating, 250.
 —, Electrical Co.'s time-check, 319.
 —, Ferranti motor, 258.
 —, Ferraris induction motor, 269.
 —, Hookham direct-current motor, 261, 265.
 —, Hookham induction motor, 304, 307.
 —, Kelvin's periodic integrating, 247.
 —, Long-Schattner electrolytic prepayment, 211.
 —, Schallenberger motor, 284.
 —, Schattner electrolytic standard, 218.
 —, Siemens' periodic integrating, 244.
 —, Thomson motor, 271.
 —, types of, 202.
 —, Vulcan motor, 279.
 —, Vulcan prepayment motor, 283.
 —, Westinghouse induction motor, 288.
 —, Wright's electrolytic, 221.
 —, types of—electro-static, 123, *et seq.*
 —, hot-wire, 123, *et seq.*
 —, induction type, 20.
 —, moving-coil dynamometer type, 19.
 —, moving-coil permanent-magnet, 19.
 —, moving-needle, 18.
- Mica insulation, 24.
 Miller's ammeters and voltmeters, 49.
 Miscellaneous instruments, 183.
 Moving-coil dynamometer ammeter, Electrical Co.'s, 79.
 — ammeter, Parr's, 71.
 —, Siemens', 61.
 — voltmeter, Electrical Co.'s, 75.
 —, Fleming & Gimmingham's, 69.
 —, Parr's, 74.
 —, Weston's portable, 80.
 —, oscillation of checked, 104.

- Moving-coil permanent-magnet ammeter and voltmeter, Davies', 84.
 ———, Electrical Co.'s., 91.
 ———, Hartmann & Braun, 108.
 ———, Kelvin recording voltmeter, 177.
 ———, "N.C.S.", 99.
 ———, Siemens', 94.
 ———, Stanley, 101.
 ———, "Victory", 110.
 ———, Weston, 101.
 ——— voltmeter, Ayrton & Mather's, 60.
 — wattmeter, Electrical Co.'s, 169.
 —, Everett, Edgumbe & Co.'s, 160.
 —, Kelvin engine-room, 157.
 —, Parr's, 168.
 —, Siemens', 154.
 —, Siemens' "Precision", 161.
 —, Weston, 156.
- Moving-magnet voltmeter, Siemens' torsional, 65.
- Moving-needle instruments, 18.
- Multicellular electro-static voltmeter, Kelvin's, 144, 149.
 ——— multiplier, Kelvin's, 147.
- Multiplier for Kelvin multicellular electro-static voltmeter, 147.
- Mutual induction in instruments, 163.
- "N.C.S." (Nalder Bros. & Thompson) ammeters and voltmeters, 37.
 ——— moving-coil ammeters and voltmeters, 99.
 ——— Edgewise voltmeter, 39.
- Needle instruments, moving-, 18.
- Neutral point resistance for instruments, Electrical Co.'s, 166, 196.
- Parallel currents, law of, 114.
- Parr's direct-reading moving-coil dynamometer ammeter, 71.
 ——— voltmeter, 74.
- Parr's dynamometer wattmeter, 168.
- Periodic integrating electricity meters, Kelvin's, 247.
 ———, Siemens', 244.
- Periodicity, measurement of, 197.
- Permanent-magnet control type of ammeter and voltmeter, 48, 55.
 — instruments, 19.
 — system of Davies' voltmeter, 88.
 — of Siemens' moving-coil instruments, 94.
- Phase, angle of, 167, 170, 195.
- Phasemeter, Electrical Co.'s induction, 194.
- Phosphor-bronze (an alloy containing a small percentage of phosphorus (1 per cent), largely used where toughness and durability are required), 134, 160.
- Platinoid (a patent alloy consisting of 59 per cent copper, 25 per cent zinc, 14 per cent nickel, 2 per cent tungsten, having a high specific resistance and low temperature coefficient), 209, 231, 239.
- Platinum-silver (a patent alloy consisting of 67 per cent of platinum and 33 per cent of silver, having a high specific resistance and low temperature coefficient), 126, 132.
- Pocket ammeters and voltmeters, 23.
- Potentiometer measuring instruments, 190.
- Power—true and apparent, 153.
- Power factor, 283.
- "Precision" wattmeter, Siemens', 161.
- Preparation electricity meter, Long-Schattner electrolytic, 211.
 ———, Vulcan motor, 283.
- Properties of an electric current, 2.
- Reactance, 171.
- Recording ammeters and voltmeters, Everett, Edgumbe, & Co.'s, 177.
 ———, Harrison's, 179-180.
 ———, Holden's, 173.
 ———, Kelvin's, 176.
 — gear of Electrical Co.'s electricity meter, 299.
 — induction wattmeter, Electrical Co.'s, 181.
 — instruments—classification, 4.
 —, general remarks, 172.
- Resetting Wright meter, 224.
- Resistance, Atkinsons' extra non-inductive voltmeter, 22.
 —, Cardew's extra non-inductive voltmeter, 130.
 — coils, 192.
 —, earth-, indicator, Stanley, 199.
 —, Electrical Co.'s neutral point, 166, 196.
 —, Siemens' extra adjustable non-inductive voltmeter, 68.
 —, Siemens' extra non-inductive wattmeter, 164.
- Resistances, extra, employed with centi-ampere balance, 187.
 — extra non-inductive, 68.
- Retarding force in meters, 204, 251, 260, 273.
- Rheostat, 192.
- Schallenberger electricity supply motor meter, 284.
- Schattner electrolytic electricity meter, 218.
- Schuckert ammeters and voltmeters, 53.
- Sector-shaped instruments, 40, 106.
- Self-induction in instruments, 163.
- Shielding, magnetic, 8, 32, 47, 52, 109.
- Shunts for instruments, low-resistance, 97, 107, 110, 112, 267-268.
- Siemens' ammeters and voltmeters, 31.
 — dynamometer wattmeter, 154.
 ———, law of the, 156.
 — moving-coil electro-dynamometer, 61.
 ———, law of, 64.
 — permanent-magnet ammeters and voltmeters, 94.
 — periodic integrating electricity clock meter, 244.
 — "Precision" wattmeter, 161.
 — torsional moving-magnet voltmeter, 65.
- Silk-fibre suspension, torsion of, 6.
- Solenoids, 9.
 —, alteration of field-strength, 10.
- Specific resistance, 13.
- Spring control, advantage of, 58.
 — controlling force, 6.
- Standard electric balances, Kelvin's, 183.
 — instruments, 183.
- Standardizing Weston ammeter, 106.
- Stanley ammeters and voltmeters, 45.
 — earth-resistance indicator, 199.
 — moving-coil permanent-magnet ammeters and voltmeters, 101.

- Sulphuric acid (a chemical substance having the composition H_2SO_4 , *i.e.* consisting of hydrogen, sulphur, and oxygen), 205, 216.
- Temperature coefficient, 13, 77.
— errors and how corrected, 13.
- Thermal demand indicator, Wright's, 233.
— electricity meter, 202.
- Thermo-stat, 211.
- Thomson (Elihu) electricity supply motor meter, 271.
- Three-phase wattmeter, Kelvin, 160.
- Time-check meter, Aron, 321.
—, Electrical Co.'s, 319.
— meters, 201.
- Torque (*i.e.* turning moment or force \times radius at which it acts), 204.
- Torsion control, 6.
- Torsional moving-magnet voltmeter, Siemens', 65.
- Transformer compensating device, 16.
— demand indicator, 242.
— induction instrument, Electrical Co.'s, 115.
- True Power, 153.
- "Victory" ammeters and voltmeters, 56.
— moving-coil permanent-magnet ammeters and voltmeters, 110.
- "Voltage transformer", 115.
- "Volt" gauge, Kelvin, 24.
- Voltmeters, classification, 4.
—, Ayrton & Mather's high-tension electro-static, 139.
—, Ayrton & Mather's low-pressure electro-static, 143.
—, Cardew's hot-wire (low-reading form), 132.
—, Cardew's hot-wire (ordinary form), 125.
—, Electrical Co.'s moving-coil dynamometer, 75.
—, electro-magnetic moving-needle, Atkinsons', 20.
—, —, "Castle", 54.
—, —, Dolivo, 44.
—, —, "E. E. C." universal, 27.
—, —, Evershed, 33.
—, —, Harrison, 30.
—, —, Hartmann & Braun, 50.
—, —, Holden, Drake, & Gorham, 40.
—, —, Kramer & Co.'s, 26.
—, —, Miller's, 49.
—, —, "N. C. S.", 37.
—, —, pocket form, 23.
—, —, Schuckert, 53.
—, —, Siemens', 31.
—, —, Stanley, 45.
—, —, "Victory", 56.
—, Fleming & Gingham's dynamometer, 69.
—, Hartmann & Braun's hot-wire, 134.
—, heating error, 13.
—, induction, Electrical Co.'s, 112.
—, —, Ferraris, 118.
—, —, Westinghouse, 120.
—, Kelvin multicellular electro-static, 144, 149.
—, moving-coil permanent-magnet, Ayrton & Mather's, 60.
- Voltmeters, moving-coil permanent-magnet, Davies', 84.
—, —, Electrical Co.'s, 91.
—, —, Evershed, 95.
—, —, Hartmann & Braun, 108.
—, —, "N. C. S.", 99.
—, —, Siemens', 94.
—, —, Stanley, 101.
—, —, "Victory", 110.
—, —, Weston, 101.
—, multiplier, Kelvin electro-static, 147.
—, Parr's moving-coil dynamometer, 74.
—, recording, Everett, Edgcumbe, & Co.'s, 177.
—, —, Harrison's, 179.
—, —, Holden's hot-wire, 173.
—, —, Kelvin's, 176.
—, Siemens' torsional moving-magnet, 65.
Voysey & Wilson's electro-static ampere meter, 150.
- Vulcan electricity supply motor meter, 279.
— meter, speed of rotation, how adjusted, 282.
— prepayment electricity supply motor meter, 283.
—, Weston's moving-coil dynamometer, 80.
- Watt-hour meters, 4, 201.
- Wattless currents, 196.
- Wattmeters, classification, 4.
—, connections to polyphase circuits, 167.
—, correcting factor of, 170.
—, Electrical Co.'s induction, 165.
—, Electrical Co.'s moving-coil alternating-current, 169.
—, Electrical Co.'s moving-coil, laboratory form, 170.
—, Electrical Co.'s recording induction, 181.
—, electro-magnetic, 153.
—, Everett, Edgcumbe & Co.'s ("E. E. C."), 160.
—, Ferraris induction, 120.
—, Kelvin engine-room, 157.
—, Kelvin three-phase, 160.
—, law of the Siemens' dynamometer, 156.
—, non-inductive, Swinburne type of, 323.
—, Parr's dynamometer, 168.
—, Siemens' dynamometer, 154.
—, Siemens' "Precision", 161.
—, Weston portable, 156.
- Westinghouse induction ammeters and voltmeters, 120.
— electricity supply motor meter, 288.
- Weston laboratory type moving-coil voltmeter, 108.
— moving-coil permanent-magnet ammeters and voltmeters, 101.
— portable moving-coil dynamometer voltmeter, 80.
— portable wattmeter, 156.
- Wright's electrolytic electricity meter, 221.
— thermal demand indicator, 233.
— — — —, special use of, 242, 243
- Zinc sulphate (a chemical substance having the composition $ZnSO_4$, *i.e.* consisting of zinc, sulphur, and oxygen), 209.



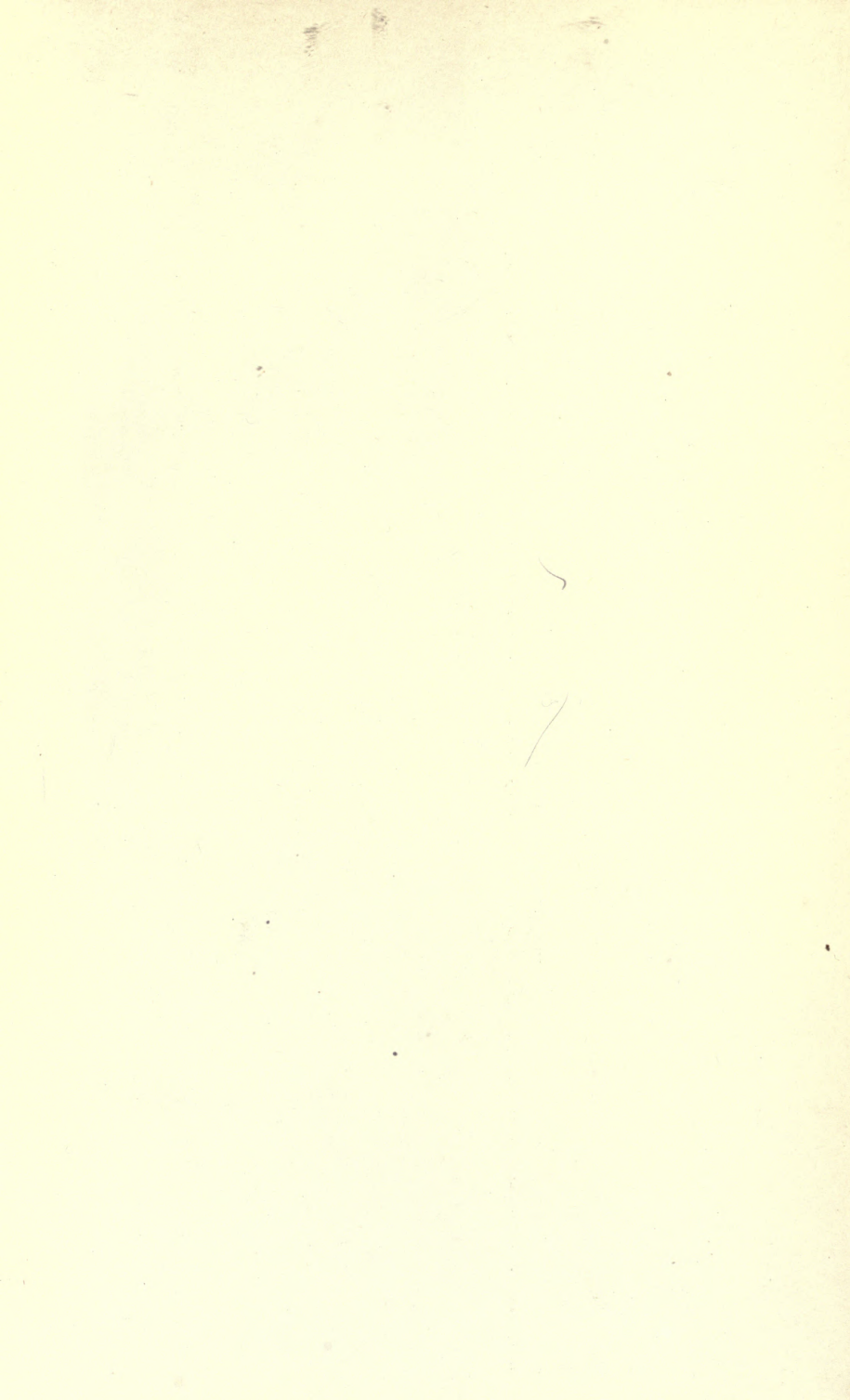

THIS BOOK IS DUE ON THE LAST DATE
STAMPED BELOW

AN INITIAL FINE OF 25 CENTS
WILL BE ASSESSED FOR FAILURE TO RETURN
THIS BOOK ON THE DATE DUE. THE PENALTY
WILL INCREASE TO 50 CENTS ON THE FOURTH
DAY AND TO \$1.00 ON THE SEVENTH DAY
OVERDUE.

FEB 19 1942 E

REC. CIR. NW 20 '33

NOV 29 1943

APR 21 1945

OCT 8 1946

NOV 11 1946

NOV 6 1947

28 Oct '48 WM

18 Oct '49 S

16 Jun '55 W O

JUN 6 - 1955 W U

OCT 21 1964

LD 21-100m-7, '40 (6936s)

119 593

QC
543
P3

THE UNIVERSITY OF CALIFORNIA LIBRARY

